

SUNON®

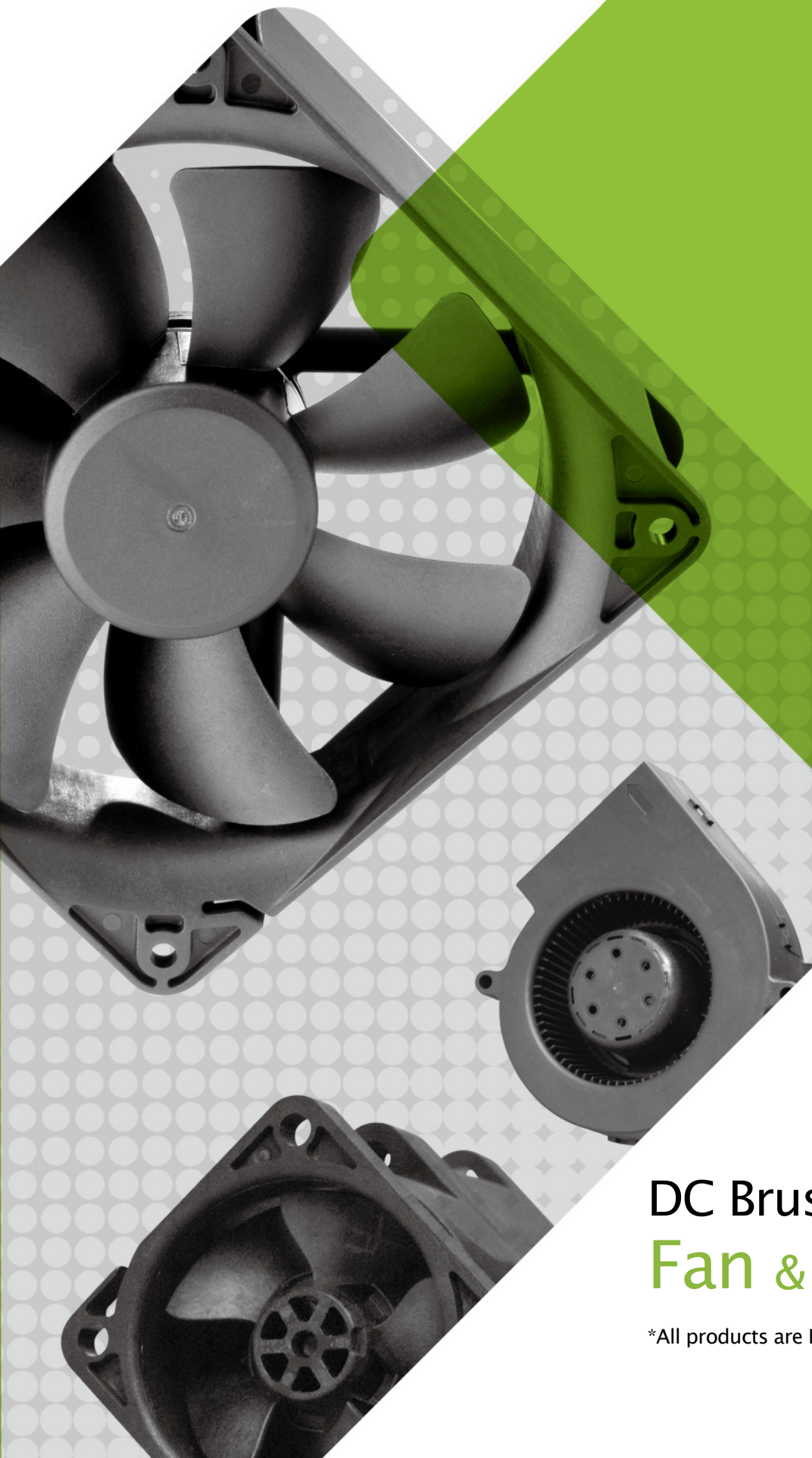

DC Brushless Fan & Blower

*All products are RoHS compliant.



TABLE of CONTENTS

■ Company Profile

Sunon Research Center	04
DR Maglev	06
Total Thermal Solution	07
Invention Innovation Center	08
Production Network	10

DC Fan

DC Fan New Model Numbering System	12
DC Fan Old Model Numbering System	13

Size (mm)	Air Flow (CFM)	Page
17 x 17 x 8	0.7 ~ 0.9	14
20 x 20 x 8	1.3 ~ 1.6	16
20 x 20 x 10	1.5 ~ 1.9	18
25 x 25 x 6	2.2 ~ 3.0	20
25 x 25 x 10	1.2 ~ 3.8	22
25 x 25 x 15	1.3 ~ 3.1	24
30 x 30 x 6	3.7 ~ 4.9	26
30 x 30 x 10	2.5 ~ 5.5	28
35 x 35 x 15	2.7 ~ 6.0	32
35 x 35 x 6	4.3 ~ 5.5	34
35 x 35 x 10	3.6 ~ 7.2	36
36 x 36 x 28	18.1 ~ 22.8	38
38 x 38 x 28	11.3 ~ 24.2	40
38 x 38 x 56	31.2	46
40 x 40 x 6	5.5 ~ 6.3	48
40 x 40 x 10	5.4~10.0	50
40 x 40 x 20	5.5 ~ 10.8	58
40 x 40 x 28	12.8 ~ 31.5	64
40 x 40 x 56	19.7 ~ 31.7	70
45 x 45 x 10	9.2 ~ 11.8	74
50 x 50 x 10	8.4 ~ 13.8	76
50 x 50 x 15	7.7 ~ 18.6	78
60 x 60 x 10	12.2 ~ 16.3	82
60 x 60 x 15	10.6 ~ 30.4	84
60 x 60 x 15 (IP)	12.7 ~ 21.3	88
60 x 60 x 20	14.1 ~ 30.5	82
60 x 60 x 25	13.8 ~ 40.0	98
60 x 60 x 38	41.5 ~ 75.2	106
60 x 60 x 56	58.5 ~ 72.9	112

Size (mm)	Air Flow (CFM)	Page
60 x 60 x 76	58.7 ~ 73.2	114
70 x 70 x 15	19.0 ~ 27.0	116
70 x 70 x 20	23.5 ~ 29.0	118
70 x 70 x 25	40.0 ~ 49.0	120
80 x 80 x 15	30.0 ~ 37.0	122
80 x 80 x 20	29.0 ~ 36.0	124
80 x 80 x 25	23.9 ~ 60.0	126
80 x 80 x 25 (IP)	33.0 ~ 60.0	136
80 x 80 x 32 (IP)	50.3 ~ 59.4	140
80 x 80 x 38	59.5 ~ 141.9	144
80 x 80 x 80	122.0 ~ 151.5	150
92 x 92 x 25	28.4 ~ 75.0	152
92 x 92 x 25 (IP)	39.5 ~ 75.0	160
92 x 92 x 38	91.7 ~ 182.4	164
120 x 120 x 25	55.0 ~ 150.0	168
120 x 120 x 38	170.0 ~ 190.0	174
140 x 140 x 38	238.5 ~ 297.9	178
140 x 140 x 51	250.3	182

DC Blower

DC Blower New Model Numbering System	184
DC Blower Old Model Numbering System	185

Size (mm)	Air Flow (CFM)	Page
50 x 50 x 15	2.6 ~ 5.4	188
50 x 50 x 20	4.8 ~ 5.7	190
60 x 60 x 15	5.1 ~ 6.2	192
75 x 75 x 30	10.8 ~ 15.5	194
97 x 94 x 33	22.4 ~ 30.5	196
97 x 95 x 33	44.2 ~ 54.7	198
100 x 100 x 25	18.4	200
120 x 120 x 32	31.4 ~ 35.9	202

SUNON.

SUNON RESEARCH CENTER

about SUNON

SUNON was founded in 1980 and has always upheld the philosophy of “Brand, Innovation, and Value” for their business operations. From the start, the SUNON name has become an international trademark that is well recognized and featured on products sold worldwide. Over the years, SUNON has continuously focused on developing and making innovations for their core motor technology, leading the industry in product trends for motors, cooling fans, and cooling modules. SUNON is one of the few operations in the world with a motor R&D team and is fully capable of developing innovative new motor designs. Examples for the R&D efforts are the world’s

first MagLev design and SUNON Mighty Mini series, featuring a compact sub-centimeter size that is the world’s smallest and thinnest fan. Today, SUNON is the worldwide leader in precision motors and micro miniature fans, and is widely recognized by the industry as the designated partner for various multinational corporations. SUNON products are widely used in various applications and industries such as information technology, network communications, optoelectronics, and automobile electronics industries, as well as in industrial production equipment, medical equipment, home applications, OA machines, and others.

SUNON Research Center the Driving Engine for Inventions and Innovations

SUNON established the “SUNON Research Center” in Kaohsiung in 2002 to promote and execute the innovation blueprint for SUNON Group. Research labs and engineers from Europe, America, Japan, and China are centralized to form a worldwide technological service network for quick and efficient services.

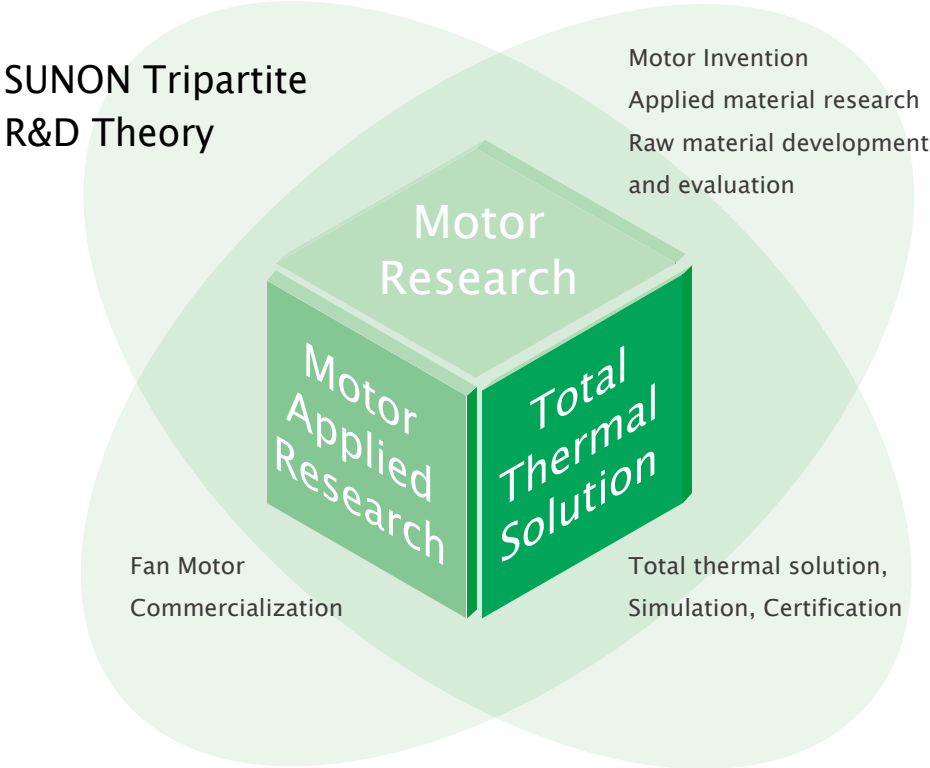

Key Modules for Innovating Core Motor Technology

SUNON has been researching their motor technology for over 40 years and adhering to the SUNON R&D Trinity as their innovation roadmap, focusing on the three major technology fields of “Motor Research,” “Motor Applied Research,” and “Total Thermal Solution.” SUNON strives to expand the endless possibilities and optimization of motor applications and will continue to make breakthroughs and product innovations. The efforts will push SUNON to the front of the technology curve and clients will be able to realize their future dream products with the three key SUNON products of motors, cooling fans, and cooling modules.

SUNON has the capacity to design and implement the complete magnetic, mechanical, and driving circuit of a motor to conform to client design specifications. With the efforts of the mechanism and electrical circuit engineering teams, SUNON recognizes the needs of their clients regarding cooling modules and can provide flexible designs for high performance and high quality cooling fans. SUNON utilizes advanced simulation systems and analysis projects that result in an even more accurate heat analysis and heat dissipation design for the system. Subsequently the most efficient total thermal solution can be provided to the client.

DR MagLev (Dust-Resistance MagLev)

The two innovative design concepts of DR MagLev development are B&S (Blanked & Seamless) Technology and S&C (Seal & Clip) Design. These innovative designs bring excellent efficiencies to extend fan life.

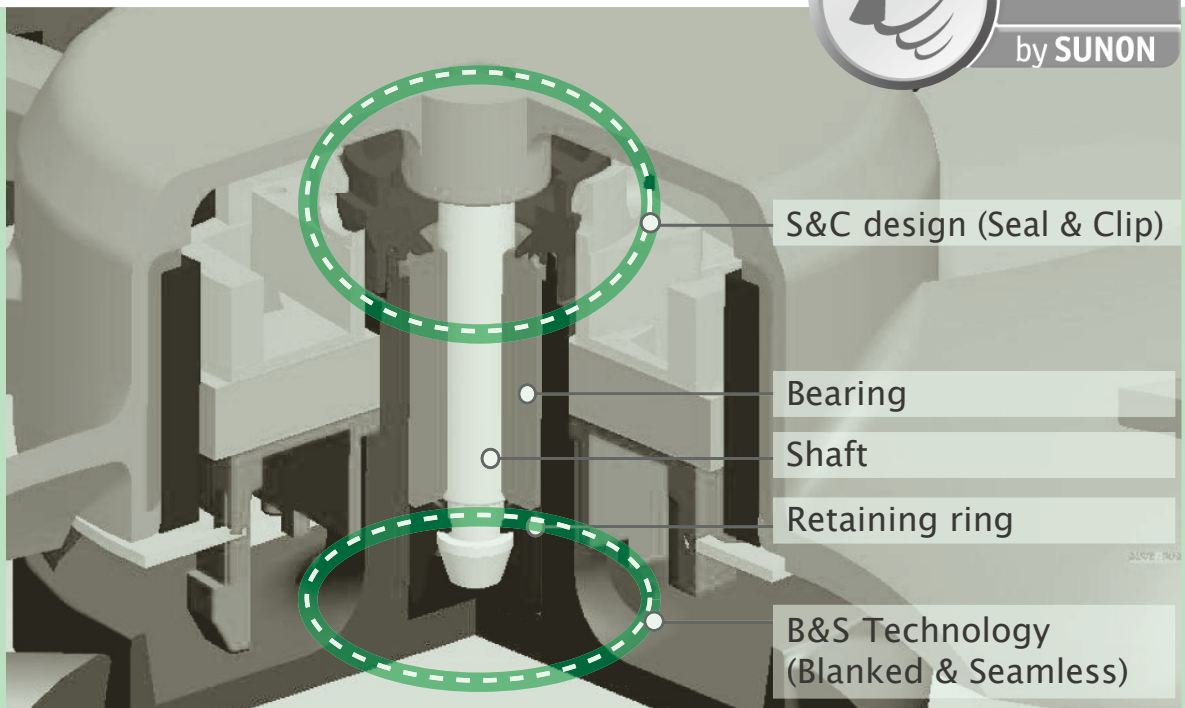

※ Note: The design concepts of DR MagLev Motor are suitable for every kind of motor and product size. The structures are different from the above picture, which was made when the DR MagLev design was applied to different motors.

1

DR MagLev provides the best resistance to dust invasion. It can solve the moving problem of the motor's components, provide better dust-resistance.

2

DR MagLev's one-piece structure with the B&S Technology and S&C Design provides the better sealed bearing system.

3

The S&C Design strengthens the locked position of both motor and stator to avoid stator and impeller from moving due to temperature changes. This allows the product to be more stable and run longer.

TOTAL THERMAL SOLUTION

- ✓ Increases product profitability
- ✓ Reduces development costs and increases profits
- ✓ Decreases prototype development time
- ✓ Provides the most economic design solution

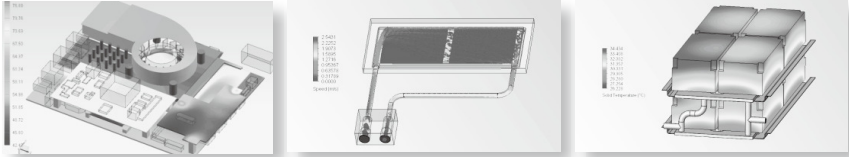

Thermal Solution & Simulation Analysis

- Individual module / system thermal analysis
- Vent Optimization
- Temperature distribution
- Velocity profile
- Pressure distribution

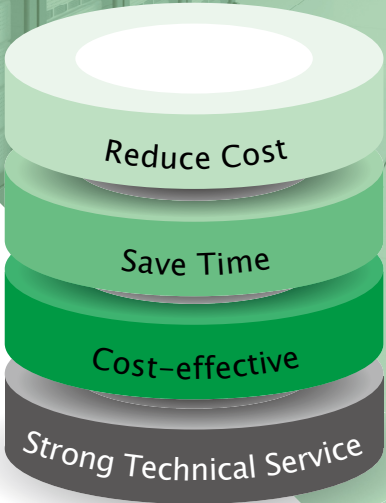

Sophisticated Tools Strengthen Design and Quality

Apart from optimized design and superior R&D, we use infrared (IR) thermal imagers in module design work to make precise measurements of module temperatures, thereby avoiding the use of conventional thermocouples to measure temperatures. Our R&D personnel can instead rely on IR images to get a clear understanding of system temperature distribution. The data from our thermal imaging reports allow us to provide a clear system-wide thermal and cooling design analysis. In order to give customers the best quality guarantee, we go well beyond industry standards in production, assembly, inspection equipment design and deployment. We have also committed large amounts of manpower and material resources, and adopted the newest hardware and software equipment in our quest for quality.

For instance, our thermal inspection systems can fully simulate thermal resistance measurements and pressure settings within systems and measure thermal resistance simultaneously at six different points. Precise measurements of pressure settings enable simulation of pressure within the system, making measurements even more accurate and protecting product quality by ensuring that excessive pressure doesn't cause product deformation. Furthermore, independent bar codes on each product ensure effective product tracking and improve the quality of after-sales service. We can satisfy our customers' needs for various types of customized cooling modules while meeting the highest quality requirements.

INVENTION INNOVATION CENTER

To ensure the high reliability of product quality, SUNON has various verification labs with strict standards for materials, testing, verification and product launch. SUNON's labs can perform material analysis, acoustic performance tests, EMC / EMI verification, product reliability verification, and UL-certified safety testing which accelerates the safety certification process.



Precision Measurements & Material Analysis

As products become more and more sophisticated and diversified, SUNON materials lab is committed to finding the key factors to improve the bearing system lifespan and materials accuracy of fan products. Besides, SUNON also aims at fixing noise, vibration and temperature rise to make motor systems more stable and improve fan products' performance. This lab also works to provide more accurate data for product development, customer projects, and product abnormalities analysis.

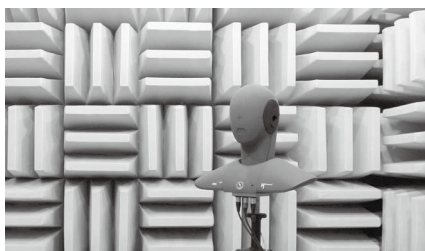

Acoustic Performance Experiment

The sound quality project was introduced in 2000. Through the HEAD Measurement System (HMS) of German Head Acoustics, SUNON has recorded and simulated human hearing sensation, and has measured sound, vibration, rotational speed and electrical appliances signal information to improve sound quality. Besides, SUNON has also used Artemis software to acquire time-domain spectroscopy, psychoacoustic parameters, and diversified sound analysis. As a result, the sound quality of SUNON's products is always pleasant and more human-friendly.

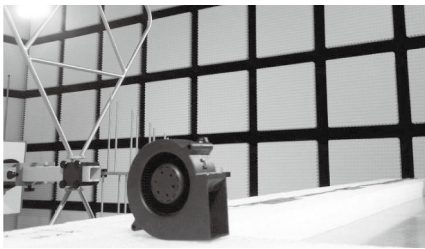

EMC / EMI Electromagnetic Compatibility Verification

The purpose of electromagnetic compatibility experiments is to ensure that all electronic products can operate normally in the same space without interfering with each other, especially crucial in the automotive field and electronic products for users' safety.



Product Reliability Verification

From design, trial production to mass production, SUNON accurately assesses product reliability through a series of rigorous testing by computer-controlled verification systems. We will, in response to the requirements of product development for various industries, continue to renew and upgrade our equipment to ensure that all stages of our production are supported with all necessary tools, whether it is in the simulation stage, the testing stage, or the production stage.

- High-temperature life testing
- High/low-temp. cycle testing
- Locked power-off testing
- Package drop testing
- Mechanical stress testing
- Environmental & reliability verification



Safety Testing and Certification

SUNON safety testing lab has enhanced the safety testing of DC, AC, EC products o development phase, and has accelerated certification awarding process to ensure product safety. We have obtained approval from UL recognized WTDP Lab, so the testing reports can be validated as safety certification reports. We have also completed some product verifications regarding energy-efficiency and explosion-proof.

SUNON®

PRODUCTION NETWORK



Kun Shan Plant



Beihai Plant



Headquarters



Kaohsiung Plant

SUNON Production Network

To ensure sufficient capacity for mass produced parts, SUNON has established four professional production facilities in the following locations: Kaohsiung, Taiwan; Foshan (Guangdong), China; Kunshan (Jiangsu), China; and Beihai (Guangxi), China. From these four locations, SUNON is capable of producing AC and DC fan and motor models that range in size from 8mm to 250mm, as well as a variety of thermal modules. Our ERP system gives us the flexibility to meet our clients' demands and our monthly production capacity.

The section header "Quality Management System" is positioned at the top left of the main content area. It is written in a green, sans-serif font. The background of the page features a diagonal grey band on the left side and a large, stylized image of a globe made of grass on the right side.

SUNON is convinced that the quality of products, as well as pursuing the technical capabilities, is the key factor for expanding product lifespan. Thus, in early 2010, SUNON endeavored to develop automation equipment, which not only enhances the stability of product quality, but also controls output efficiency more accurately. Moreover, the adoption of digital management and product quality tracking system becomes an important milestone for SUNON.

The section header "Green Product Management System" is located below the first section. It is written in a green, sans-serif font.

SUNON has obtained ISO 14001, ISO45001, and IECQ QC080000 certification for the environmental management system of its facilities in Kaohsiung, Taiwan, Kunshan, China, and Foshan, China. The appeal of SUNON's product design and development is environmental protection and energy-savings, and we have invested in green designs that will reduce material consumption and save electricity. In the production process, we have asked our suppliers to comply with the provisions of the RoHS Directives in their manufacturing process by not using prohibited materials, and the process of product development should also meet the requirements for environmental protection.

Furthermore, we also pay close attention to various international issues on the protection of the environment and the use of energy and have promoted the standardization of halogen-free to ensure that its products are fully compliant with the green environmental provisions in new chemical policies as stipulated in RoHS Directives and REACH. As a responsible corporate citizen of the world, SUNON is an advocate in the prevention of abuses and hostilities in the exploitation and trade of these conflict resources that result in serious violation of international human rights. SUNON promise to reject metals and materials obtained from the conflict mining regions.

We will protect our employees, the customers we serve, and the environments in which we operate. Moreover, SUNON has also educated its employees to make them realize the importance of environmental protection and energy saving. In addition to the establishment of a process and system for the computerization of documents, we also vigorously promote the 6S policies (Sort, Set, Shine, Standardize, Sustain, and Safety), hoping that SUNON can serve as a good example and unite more people to improve the environment of the earth in which we live in! We expect to forge An Entirely Green SUNON .



Declaration of Conflict-Free Minerals



Declaration of REACH Compliance



Declaration of RoHS Compliance

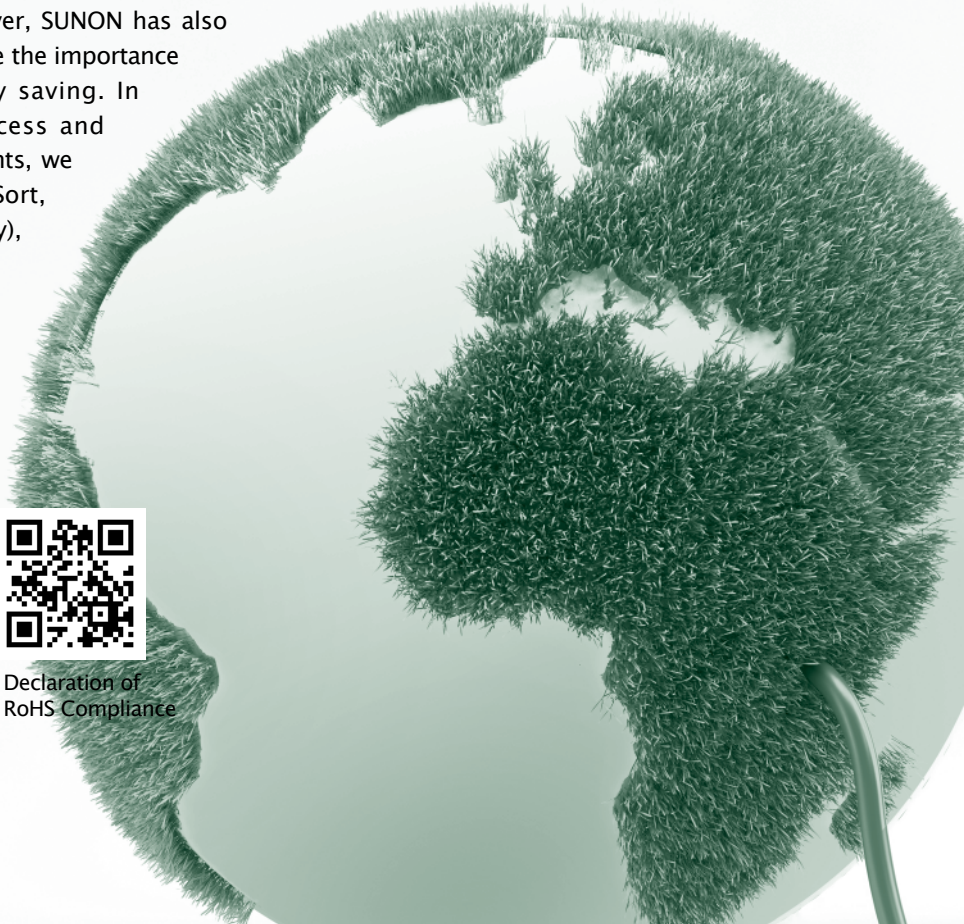

■ DC Fan New Model Numbering System

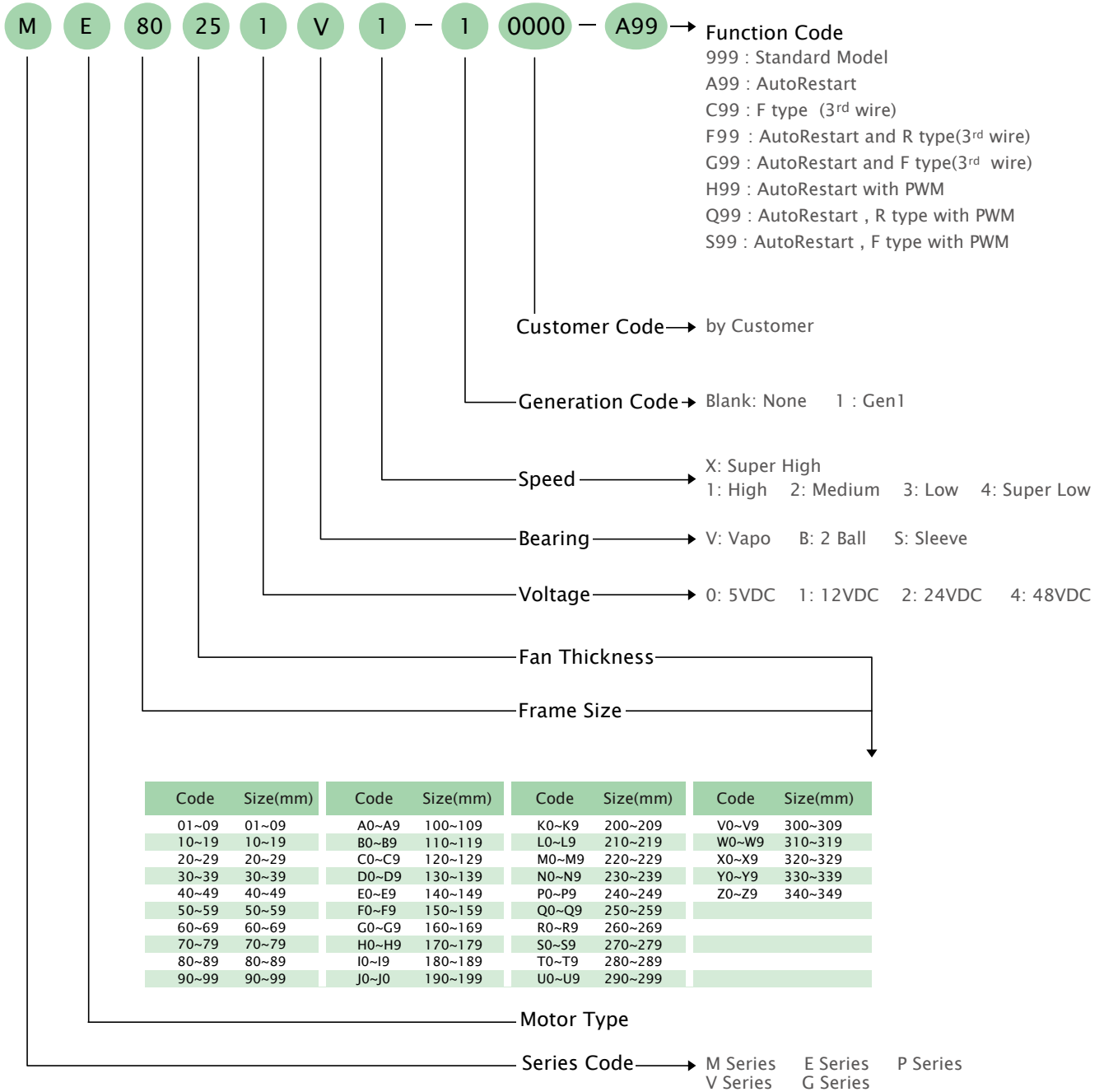

Certification



Safety



- ※ Note: For critical or extreme environments, including non stop operation, please contact SUNON and we will gladly provide assistance with your product selection to ensure an appropriate cooling product for your application.
- ※ Note: The "Life Expectancy" of the fan has not been evaluated for use in combination with any end application. Therefore, the Life Expectancy Test Reports(L10 and MTTF Report) that relate to the fan are only for reference.

■ DC Fan Old Model Numbering System

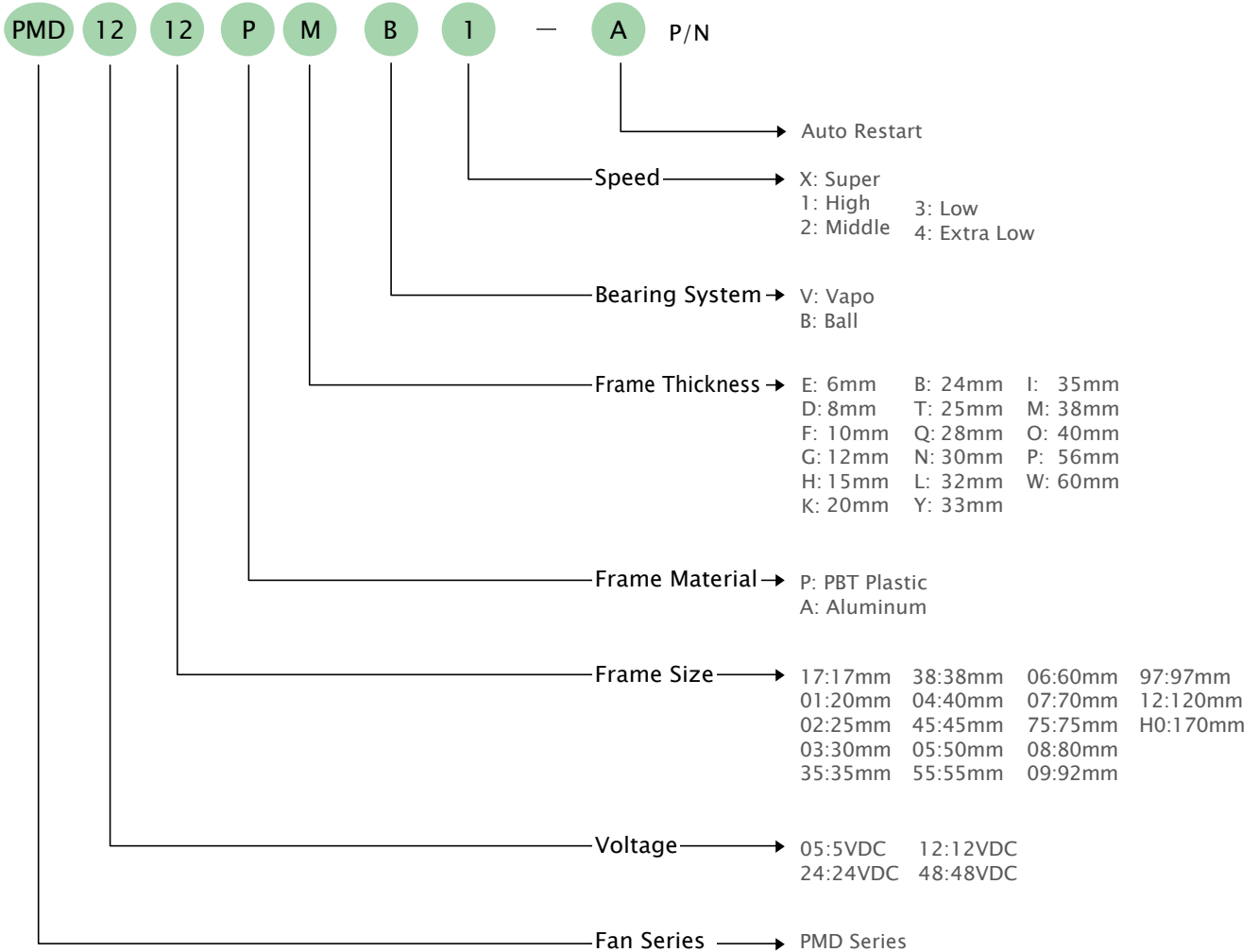

P/N

Example: PMD1212PMB1-A P/N: (2).GN

- (2) Two ball bearing
- A Auto restart
- F 3rd wire with frequency generation waveform
- R 3rd wire with rotation detector waveform
- Z Specific RPM
- PWM with PWM function
- GN RoHS compliance

Certification



Safety



※ Note: For critical or extreme environments, including non stop operation, please contact SUNON and we will gladly provide assistance with your product selection to ensure an appropriate cooling product for your application.

※ Note: The "Life Expectancy" of the fan has not been evaluated for use in combination with any end application. Therefore, the Life Expectancy Test Reports(L10 and MTTF Report) that relate to the fan are only for reference.

17x17x8 mm

0.7~0.9 CFM

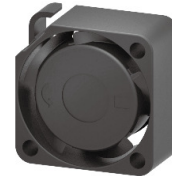

■ Specification

	Bearing	Rated Voltage	Power Current	Power Consumption	Speed	Airflow	Static Pressure	Noise	Weight	Curve
	● VAPO	(VDC)	(mA)	(WATTS)	(RPM)	(CFM)	(inch-H ₂ O)	(dB(A))	(g)	
MF17080V1-10000-A99	●	5	93	0.47	21000	0.9	0.28	21.5	3.9	1
MF17080V2-10000-A99	●	5	66	0.33	16500	0.7	0.17	14.2	3.9	2

■ Function R Type : F99 / F Type : G99 / PWM : H99, Q99, S99

■ Air Flow-Static Pressure Characteristics

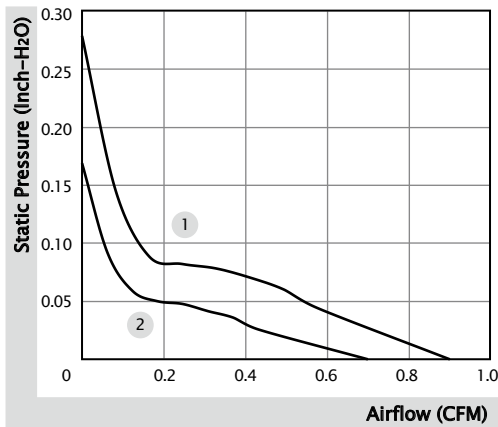

■ External Dimensions(mm)

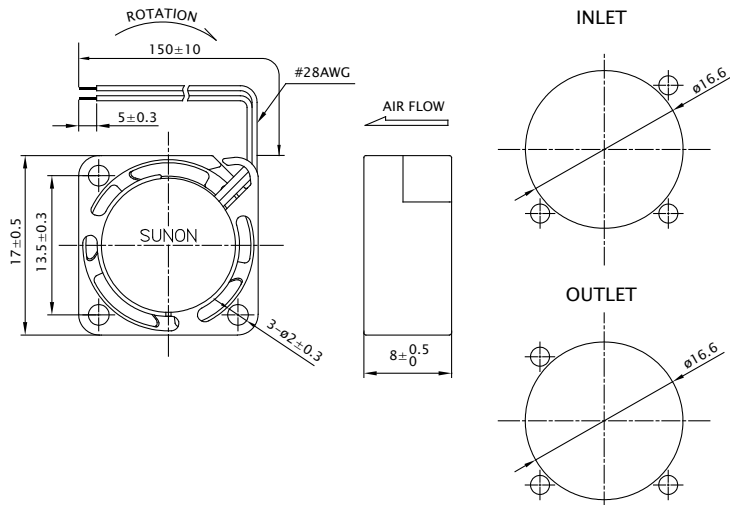

※ All model could be customized. Please contact with Sunon Sales.

※ Specifications are subject to change without notice. Please Visit SUNON website at www.sunon.com for update information.

■ RD / FG Output Signal

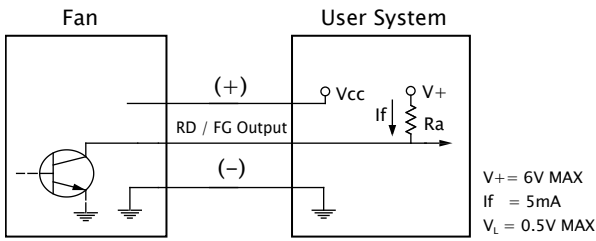

[RD Signal]

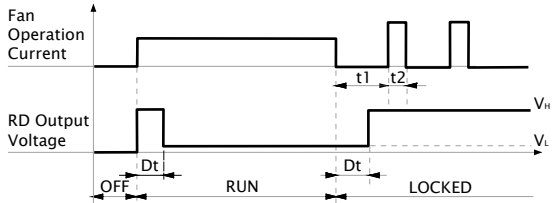

[FG Signal]

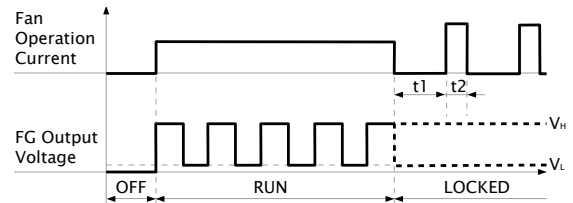
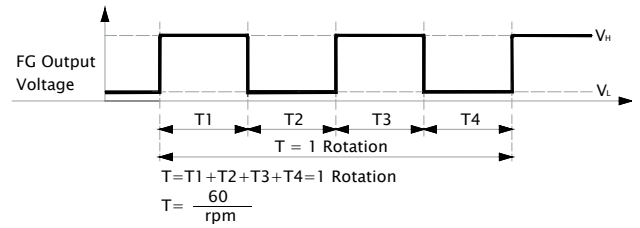

■ PWM Input Signal

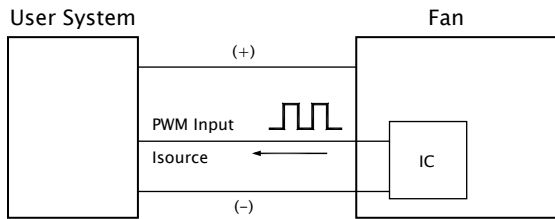

PWM FREQUENCY: 25KHZ
 Isource=0.6mA at PWM Input Voltage 0V
 The speed is default to be maximum if PWM input pin is unconnected.
 Min. start up duty cycle is 20%.

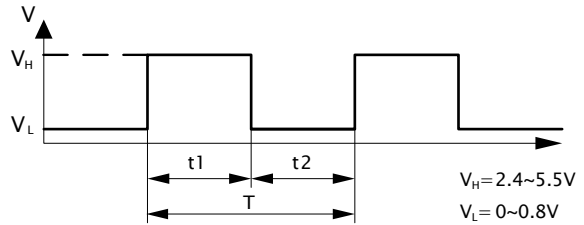

1. Period : $T = \frac{1}{f_{PWM}} = t1 + t2(\text{sec})$

2. Duty Cycle (D.C.) : $\frac{t1}{t1+t2} \times 100 = \frac{t1}{T} \times 100(\%)$

■ PWM Curve

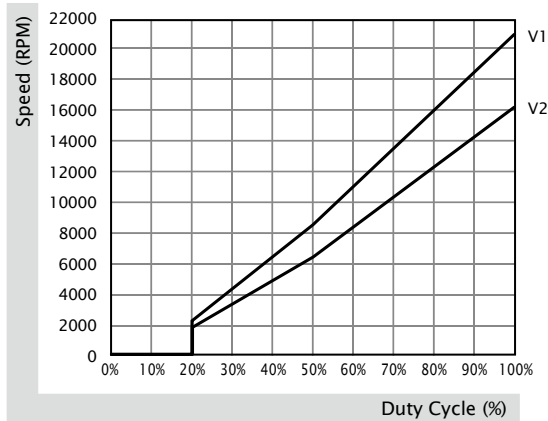

20x20x8 mm

1.3~1.6 CFM



■ Specification

	Bearing	Rated Voltage	Power Current	Power Consumption	Speed	Airflow	Static Pressure	Noise	Weight	Curve
	● VAPO	(VDC)	(mA)	(WATTS)	(RPM)	(CFM)	(inch-H ₂ O)	(dB(A))	(g)	
MF20080V1-10000-A99	●	5	90	0.45	15000	1.6	0.24	23.0	4.0	1
MF20080V2-10000-A99	●	5	68	0.34	12000	1.3	0.15	21.0	4.0	2

■ Function R Type : F99 / F Type : G99 / PWM : H99, Q99, S99

■ Air Flow-Static Pressure Characteristics

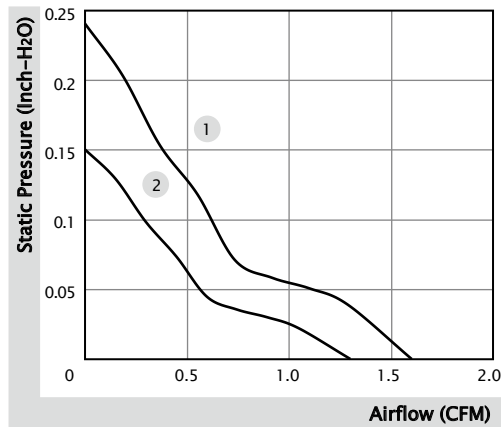

■ External Dimensions(mm)

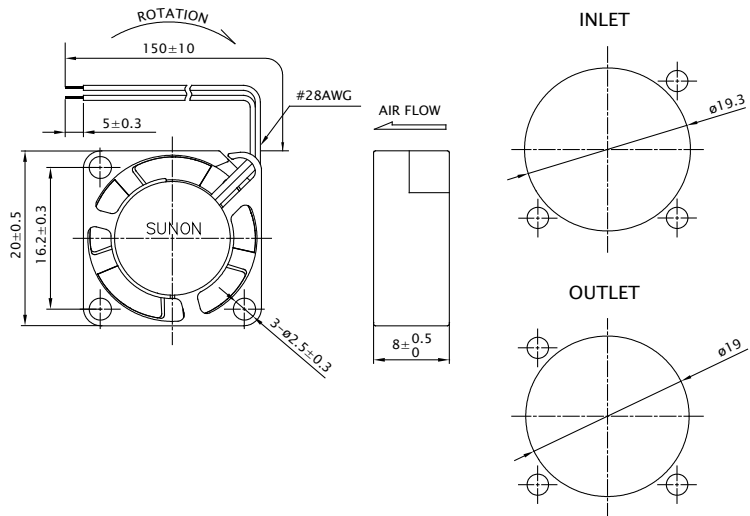

※ All model could be customized. Please contact with Sunon Sales.

※ Specifications are subject to change without notice. Please Visit SUNON website at www.sunon.com for update information.

■ RD / FG Output Signal

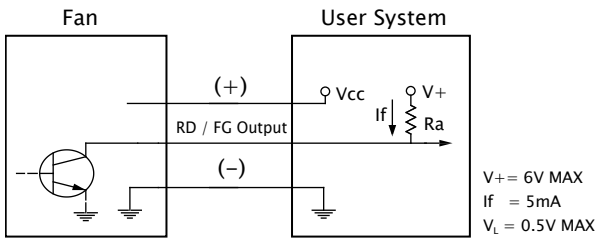

[RD Signal]

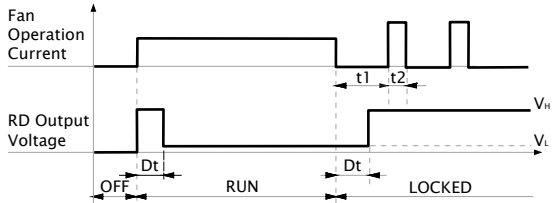

[FG Signal]

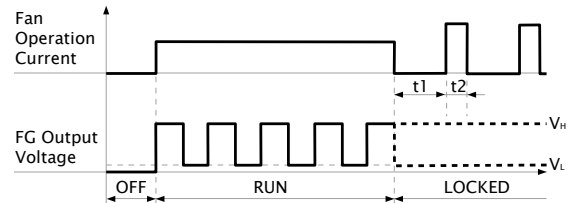
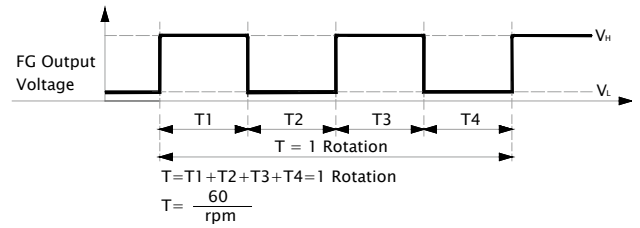

■ PWM Input Signal

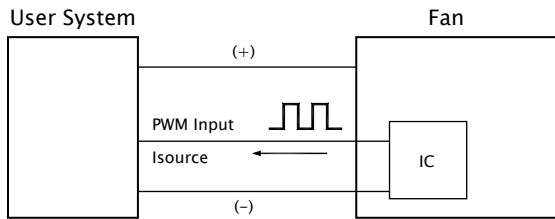

PWM FREQUENCY: 25KHZ
 $I_{\text{source}} = 0.6\text{mA}$ at PWM Input Voltage 0V
 The speed is default to be maximum if PWM input pin is unconnected.
 V1 Min. start up duty cycle is 20%.
 V2 Min. start up duty cycle is 60%.

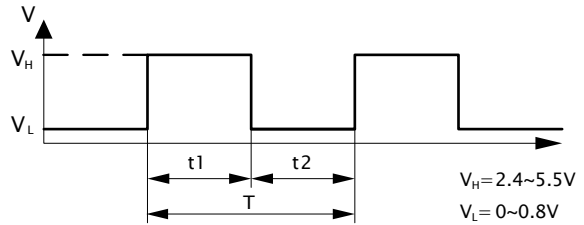

1. Period : $T = \frac{1}{f_{\text{PWM}}} = t_1 + t_2 (\text{sec})$

2. Duty Cycle (D.C.) : $\frac{t_1}{t_1 + t_2} \times 100 = \frac{t_1}{T} \times 100(\%)$

■ PWM Curve

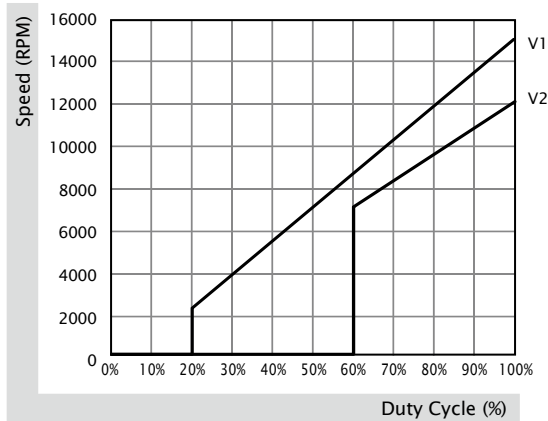

20x20x10 mm

1.5~1.9 CFM

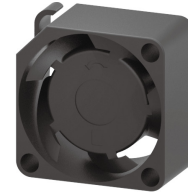

■ Specification

	Bearing	Rated Voltage	Power Current	Power Consumption	Speed	Airflow	Static Pressure	Noise	Weight	Curve
	● VAPO	(VDC)	(mA)	(WATTS)	(RPM)	(CFM)	(inch-H ₂ O)	(dB(A))	(g)	
MF20100V1-10000-A99	●	5	106	0.53	16500	1.9	0.29	25.0	4.65	1
MF20100V2-10000-A99	●	5	80	0.40	14000	1.5	0.20	20.0	4.65	2

■ Function R Type : F99 / F Type : G99 / PWM : H99, Q99, S99

■ Air Flow-Static Pressure Characteristics

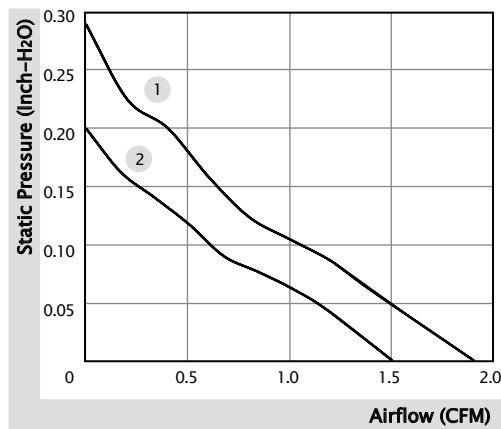

■ External Dimensions(mm)

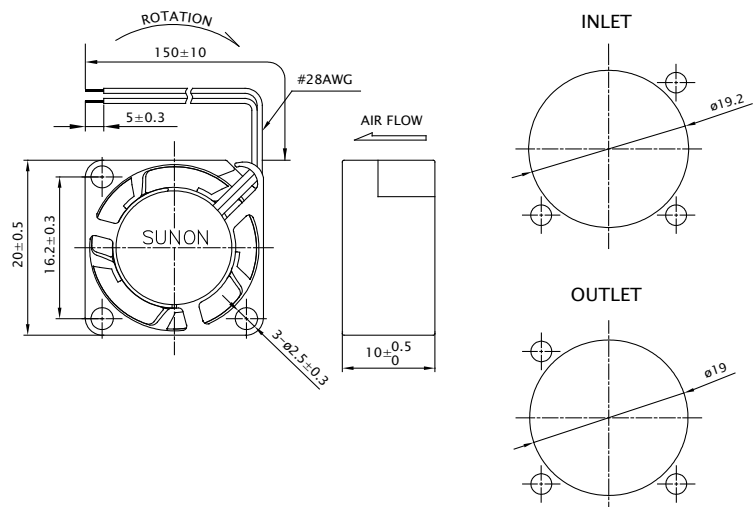

※ All model could be customized. Please contact with Sunon Sales.

※ Specifications are subject to change without notice. Please Visit SUNON website at www.sunon.com for update information.

■ RD / FG Output Signal

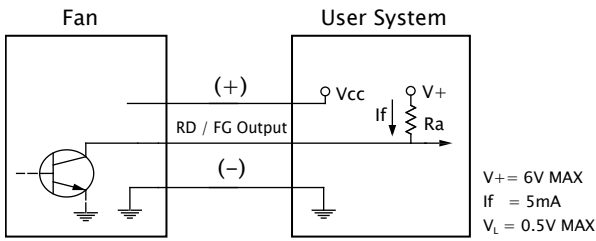

[RD Signal]

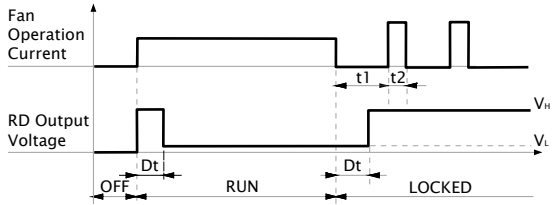

[FG Signal]

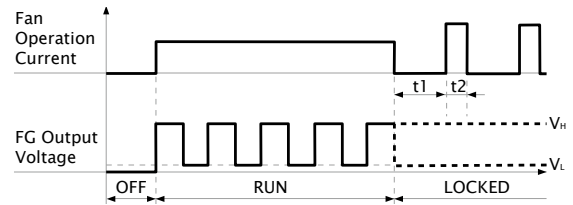
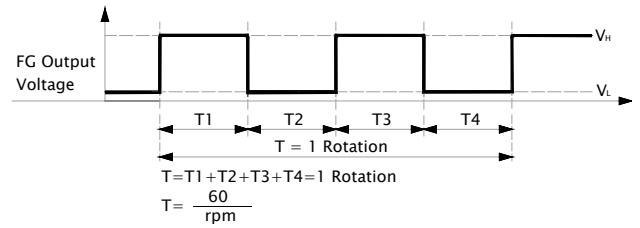

■ PWM Input Signal

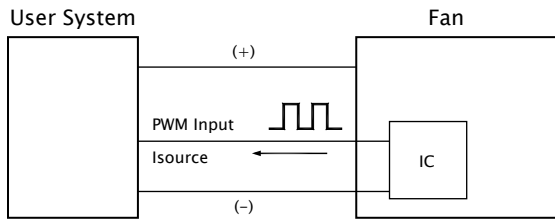

PWM FREQUENCY: 25KHZ
 $I_{source} = 0.6\text{mA}$ at PWM Input Voltage 0V
 The speed is default to be maximum if PWM input pin is unconnected.
 Min. start up duty cycle is 20%.

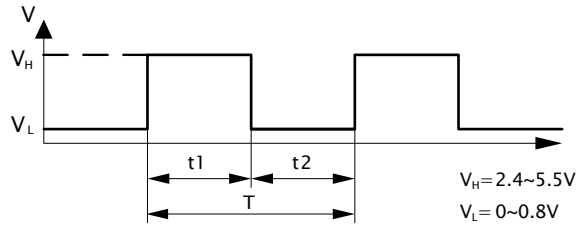

1. Period : $T = \frac{1}{f_{PWM}} = t1 + t2(\text{sec})$

2. Duty Cycle (D.C.) : $\frac{t1}{t1+t2} \times 100 = \frac{t1}{T} \times 100(\%)$

■ PWM Curve

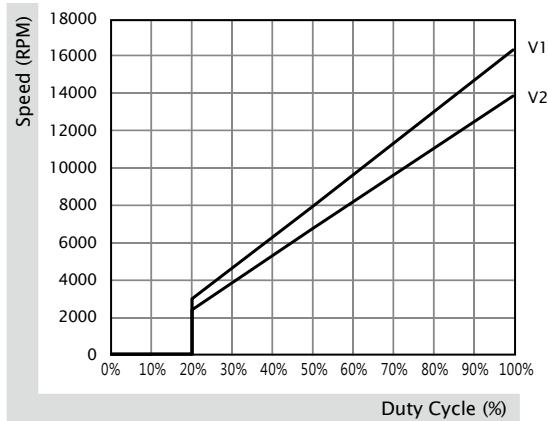

25x25x6 mm

2.2~3.0 CFM



■ Specification

	Bearing	Rated Voltage	Power Current	Power Consumption	Speed	Airflow	Static Pressure	Noise	Weight	Curve
	● VAPO	(VDC)	(mA)	(WATTS)	(RPM)	(CFM)	(inch-H ₂ O)	(dB(A))	(g)	
MF25060V1-10000-A99	●	5	115	0.58	13000	3.0	0.23	24.8	5.0	1
MF25060V2-10000-A99	●	5	75	0.38	10000	2.2	0.16	18.0	5.0	2

■ Function R Type : F99 / F Type : G99 / PWM : H99, Q99, S99

■ Air Flow-Static Pressure Characteristics

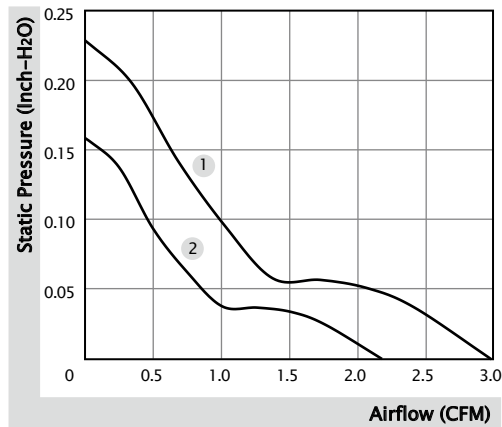

■ External Dimensions(mm)

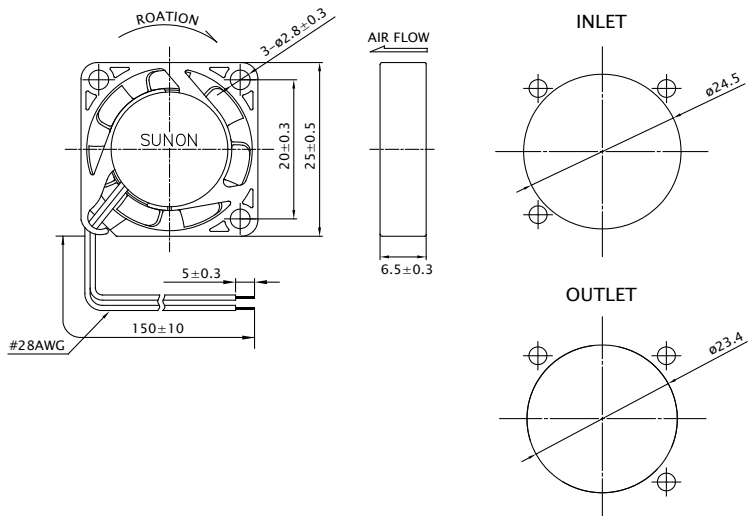

※ All model could be customized. Please contact with Sunon Sales.

※ Specifications are subject to change without notice. Please Visit SUNON website at www.sunon.com for update information.

■ RD / FG Output Signal

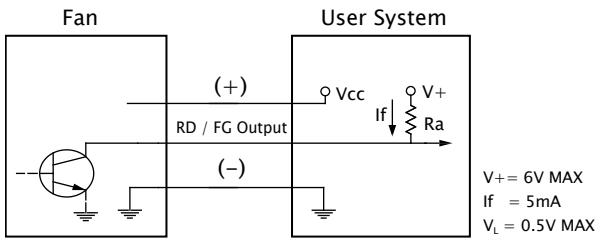

[RD Signal]

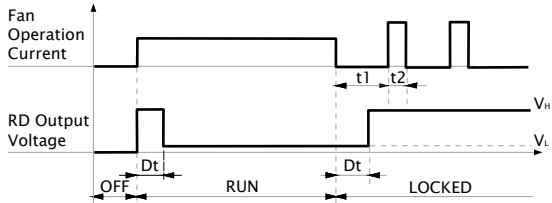

[FG Signal]

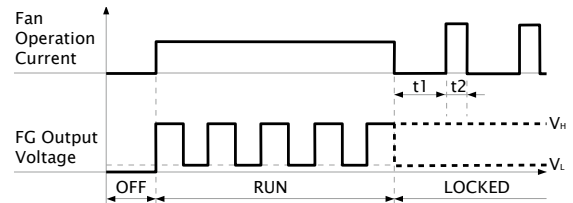
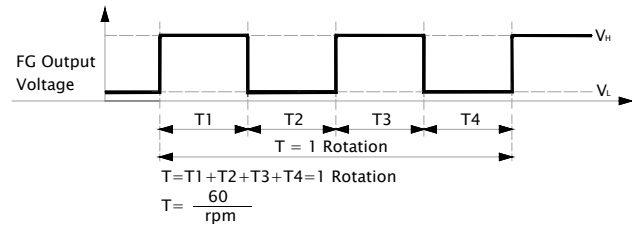

■ PWM Input Signal

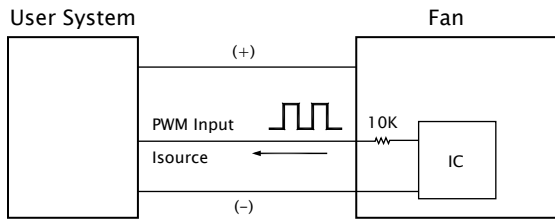

PWM FREQUENCY: 25KHZ
 Isource=0.6mA at PWM Input Voltage 0V
 The speed is default to be maximum if PWM input pin is unconnected.
 Min. start up duty cycle is 20%.

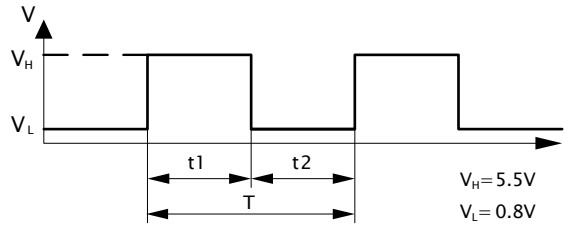

1. Period : $T = \frac{1}{f_{PWM}} = t1 + t2(\text{sec})$

2. Duty Cycle (D.C.) : $\frac{t1}{t1+t2} \times 100 = \frac{t1}{T} \times 100(\%)$

■ PWM Curve

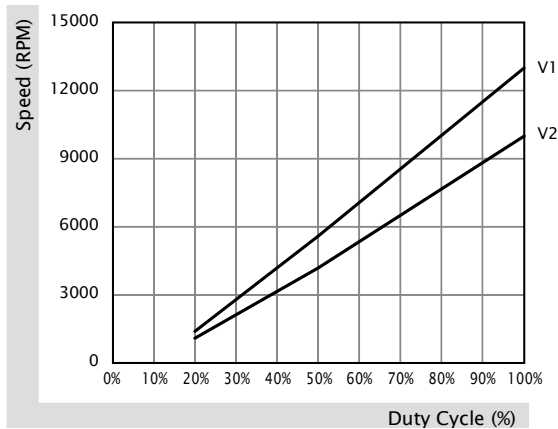

25x25x10 mm

1.2~3.8 CFM



■ Specification

	Bearing	Rated Voltage	Power Current	Power Consumption	Speed	Airflow	Static Pressure	Noise	Weight	Curve
	● VAPO	(VDC)	(mA)	(WATTS)	(RPM)	(CFM)	(inch-H ₂ O)	(dB(A))	(g)	
MF25100V1-10000-A99	●	5	105	0.53	13000	3.5	0.25	23.0	6.9	2
MF25100V2-10000-A99	●	5	65	0.33	9800	3.0	0.18	16.0	6.9	3
MF25100V3-10000-A99	●	5	40	0.20	6800	1.3	0.07	8.8	6.9	4
MF25101V1-10000-A99	●	12	50	0.60	14000	3.8	0.27	26.0	6.8	1
MF25101V2-10000-A99	●	12	30	0.36	9600	3.0	0.18	16.0	6.8	3
MF25101V3-10000-A99	●	12	17	0.21	6000	1.2	0.05	4.8	6.8	5

■ Function (5V) R Type : F99 / F Type : G99 / PWM : H99, Q99, S99
 (12V) R Type : F99 / F Type : G99

■ Air Flow-Static Pressure Characteristics

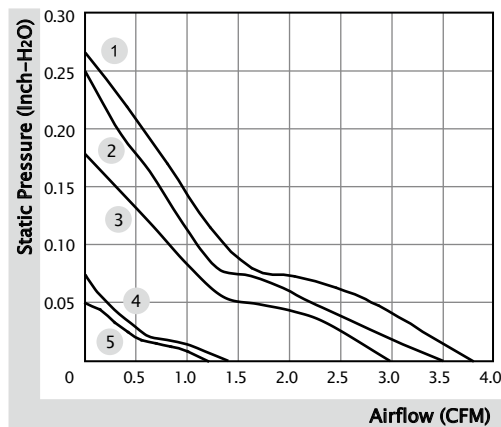

■ External Dimensions(mm)

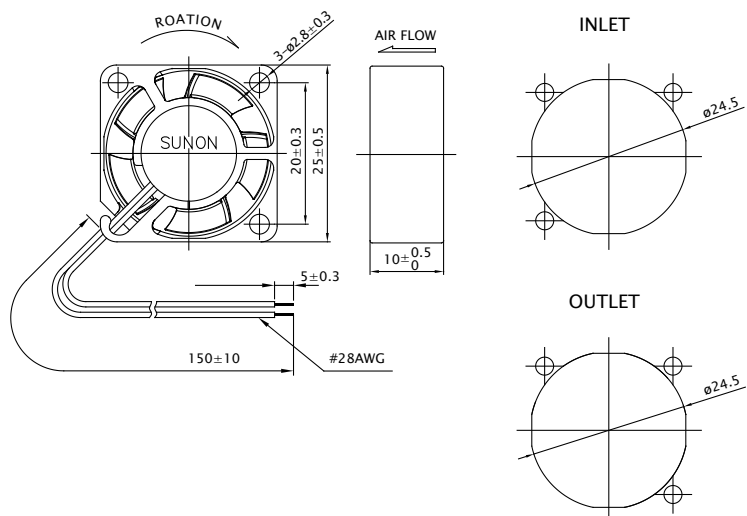

※ All model could be customized. Please contact with Sunon Sales.

※ Specifications are subject to change without notice. Please Visit SUNON website at www.sunon.com for update information.

■ RD / FG Output Signal

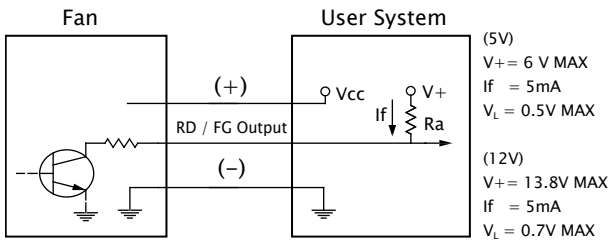

[RD Signal]

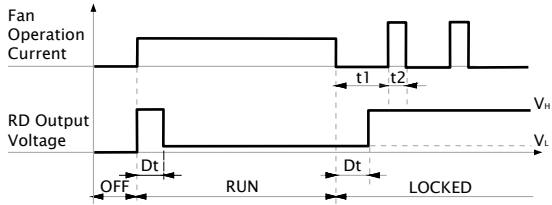

[FG Signal]

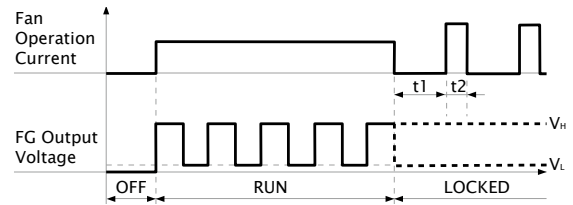
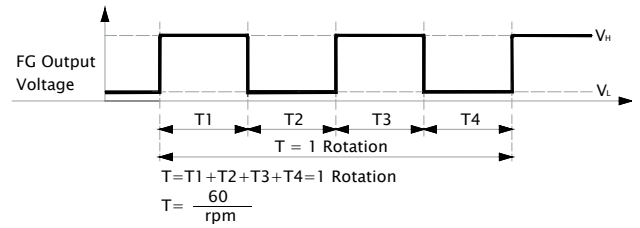

■ PWM Input Signal

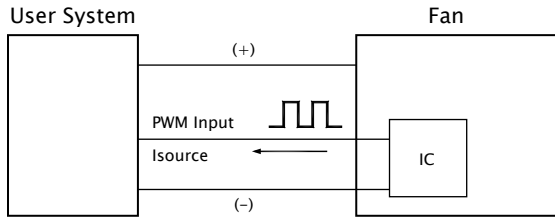

PWM FREQUENCY: 25KHZ
 $I_{source} = 0.6\text{ mA}$ at PWM Input Voltage 0V
 The speed is default to be maximum if PWM input pin is unconnected.
 Min. start up duty cycle is 20%.

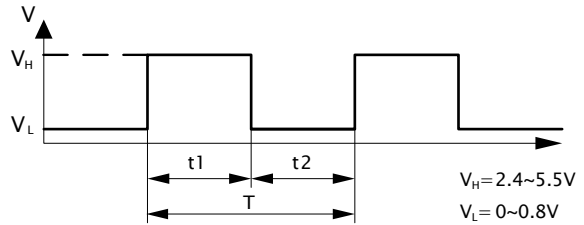

1. Period : $T = \frac{1}{f_{PWM}} = t1 + t2(\text{sec})$

2. Duty Cycle (D.C.) : $\frac{t1}{t1 + t2} \times 100 = \frac{t1}{T} \times 100(\%)$

■ PWM Curve

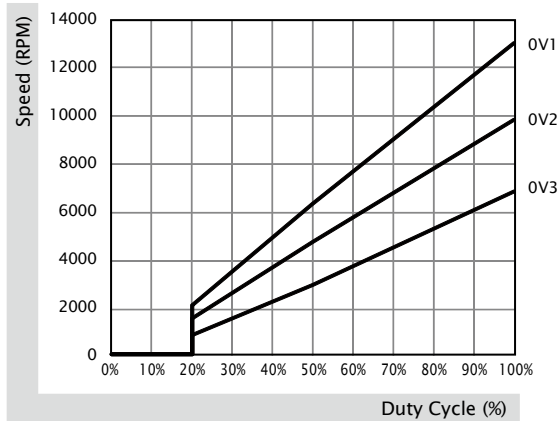

25x25x15 mm

1.3~3.1 CFM



■ Specification

	Bearing	Rated Voltage	Power Current	Power Consumption	Speed	Airflow	Static Pressure	Noise	Weight	Curve
	● VAPO	(VDC)	(mA)	(WATTS)	(RPM)	(CFM)	(inch-H ₂ O)	(dB(A))	(g)	
MF25150V1-10000-A99	●	5	85	0.43	10000	3.1	0.16	20.0	9.4	1
MF25150V2-10000-A99	●	5	46	0.23	6800	2.2	0.11	11.3	9.4	2
MF25150V3-10000-A99	●	5	35	0.18	5300	1.3	0.04	4.5	9.4	3

■ Function R Type : F99 / F Type : G99 / PWM : H99, Q99, S99

■ Air Flow-Static Pressure Characteristics

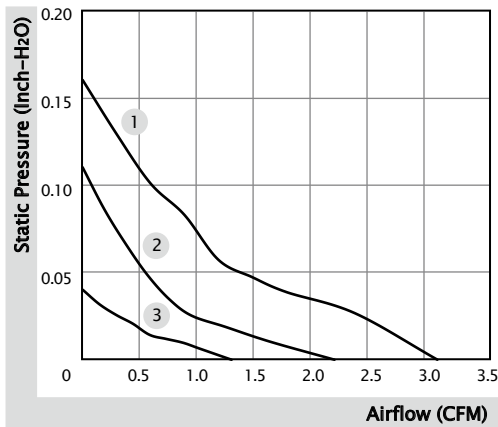

■ External Dimensions(mm)

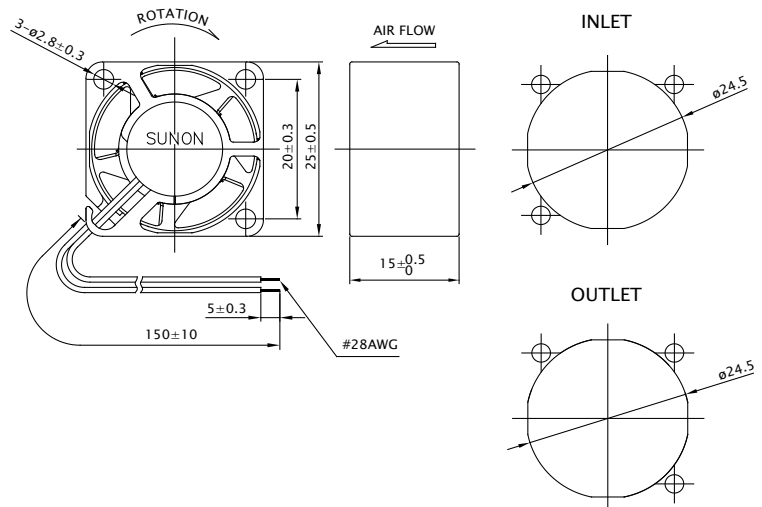

※ All model could be customized. Please contact with Sunon Sales.

※ Specifications are subject to change without notice. Please Visit SUNON website at www.sunon.com for update information.

■ RD / FG Output Signal

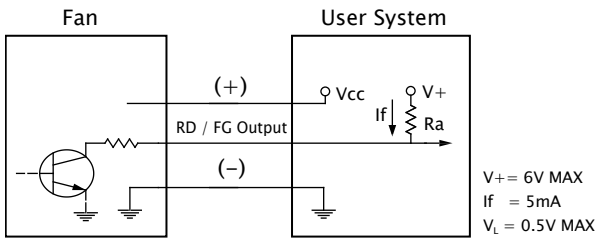

[RD Signal]

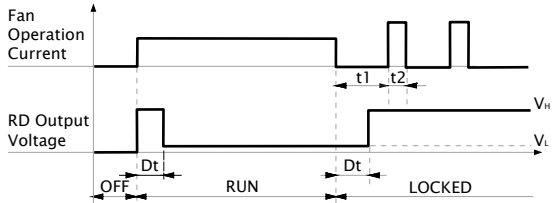

[FG Signal]

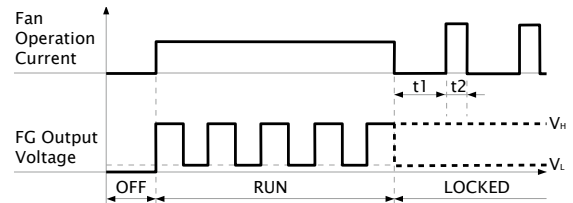
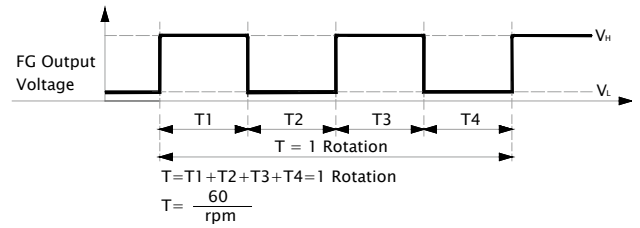

■ PWM Input Signal

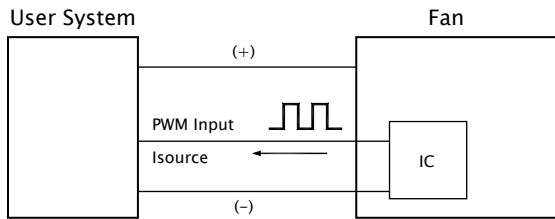

PWM FREQUENCY: 25KHZ
 Isource=0.6mA at PWM Input Voltage 0V
 The speed is default to be maximum if PWM input pin is unconnected.
 V1, V2 Min. start up duty cycle is 20%.
 V3 Min. start up duty cycle is 30%.

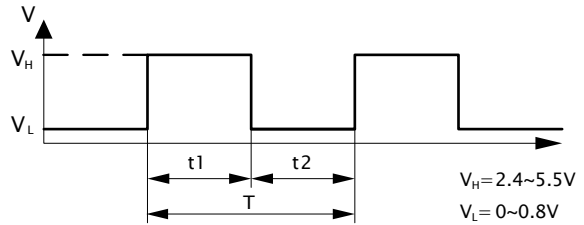

1. Period : $T = \frac{1}{f_{PWM}} = t1 + t2(\text{sec})$
2. Duty Cycle (D.C.) : $\frac{t1}{t1+t2} \times 100 = \frac{t1}{T} \times 100(\%)$

■ PWM Curve

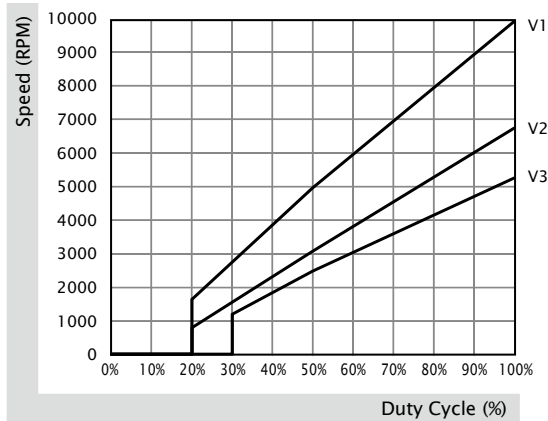

30x30x6 mm

3.7~4.9 CFM



■ Specification

	Bearing	Rated Voltage	Power Current	Power Consumption	Speed	Airflow	Static Pressure	Noise	Weight	Curve
	● VAPO	(VDC)	(mA)	(WATTS)	(RPM)	(CFM)	(inch-H ₂ O)	(dB(A))	(g)	
MF30060V1-10000-A99	●	5	112	0.56	9100	4.9	0.17	23.6	6.0	1
MF30060V2-10000-A99	●	5	72	0.36	7100	3.7	0.11	15.7	6.0	2

■ Function R Type : F99 / F Type : G99 / PWM : H99, Q99, S99

■ Air Flow-Static Pressure Characteristics

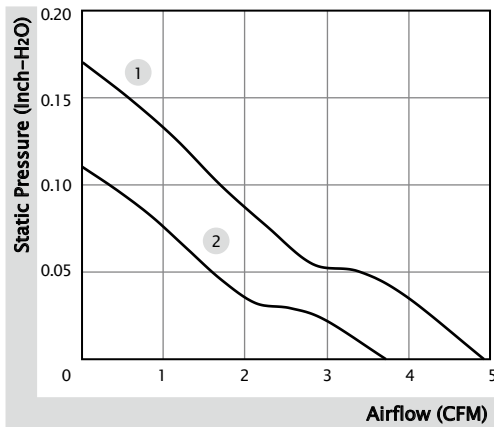

■ External Dimensions(mm)

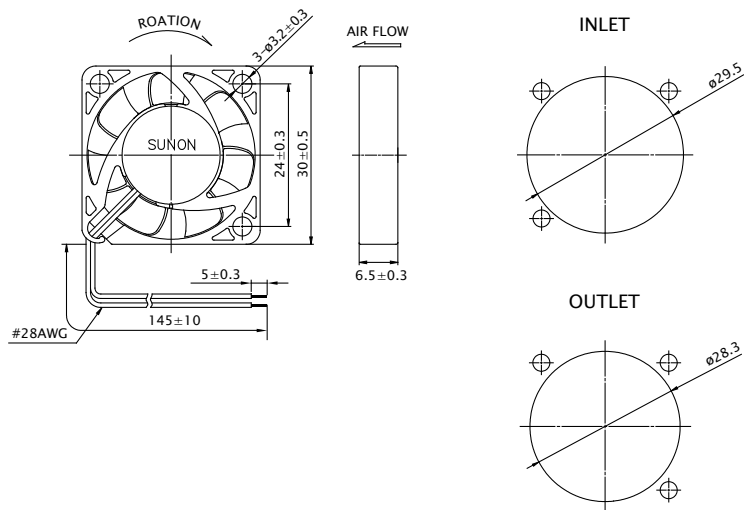

※ All model could be customized. Please contact with Sunon Sales.

※ Specifications are subject to change without notice. Please Visit SUNON website at www.sunon.com for update information.

■ RD / FG Output Signal

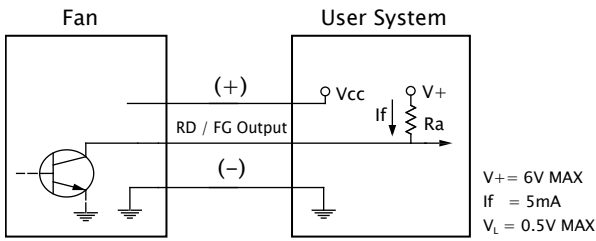

[RD Signal]

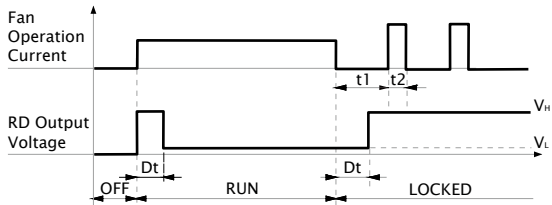

[FG Signal]

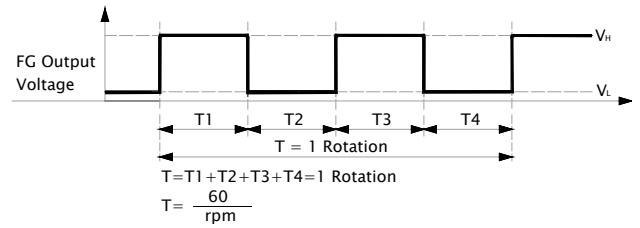

■ PWM Input Signal

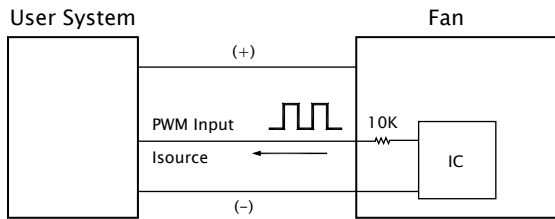

PWM FREQUENCY: 25KHZ
 Isource=0.6mA at PWM Input Voltage 0V
 The speed is default to be maximum if PWM input pin is unconnected.
 Min. start up duty cycle is 20%.

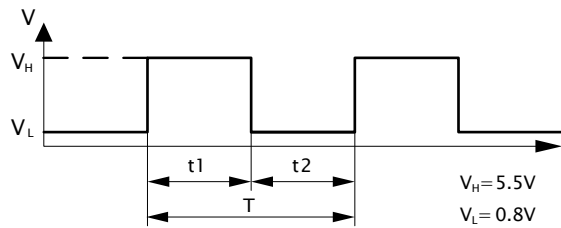

1. Period : $T = \frac{1}{f_{PWM}} = t1 + t2(\text{sec})$

2. Duty Cycle (D.C.) : $\frac{t1}{t1+t2} \times 100 = \frac{t1}{T} \times 100(\%)$

■ PWM Curve

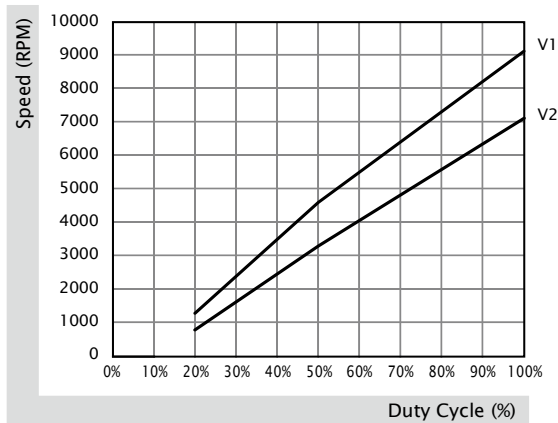

30x30x10 mm

2.5~5.5 CFM

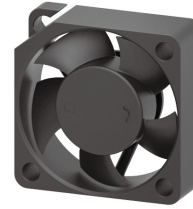

■ Specification

	Bearing	Rated Voltage	Power Current	Power Consumption	Speed	Airflow	Static Pressure	Noise	Weight	Curve
	● VAPO	(VDC)	(mA)	(WATTS)	(RPM)	(CFM)	(inch-H ₂ O)	(dB(A))	(g)	
MF30100V1-10000-A99	●	5	120	0.60	11000	5.5	0.20	23.0	7.8	2
MF30100V2-10000-A99	●	5	80	0.40	9500	4.7	0.17	21.0	7.8	3
MF30100V3-10000-A99	●	5	45	0.23	6000	2.5	0.07	10.2	7.8	5
MF30101V1-10000-A99	●	12	55	0.66	11500	5.5	0.25	23.0	7.8	1
MF30101V2-10000-A99	●	12	32	0.39	8600	4.6	0.14	20.0	7.8	4

■ Function (5V) R Type : F99 / F Type : G99 / PWM : H99, Q99, S99
 (12V) R Type : F99 / F Type : G99

■ Air Flow-Static Pressure Characteristics

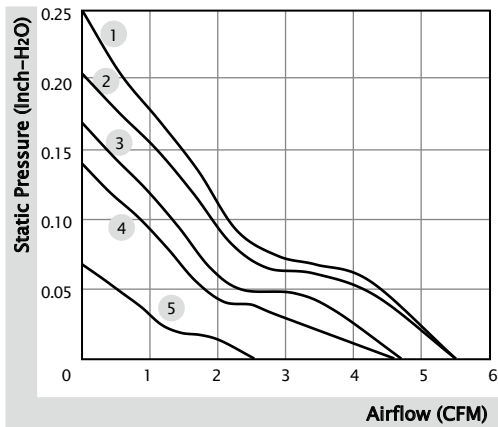

■ External Dimensions(mm)

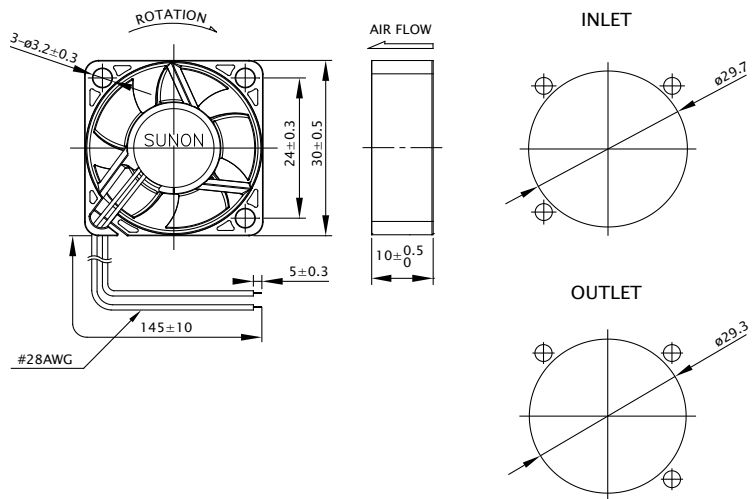

※ All model could be customized. Please contact with Sunon Sales.

※ Specifications are subject to change without notice. Please Visit SUNON website at www.sunon.com for update information.

■ RD / FG Output Signal

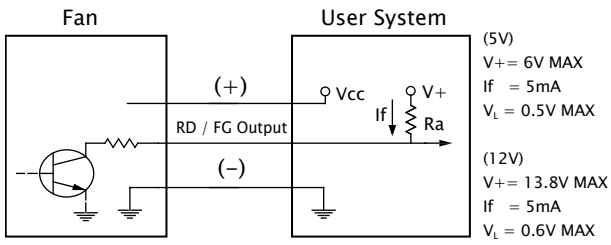

[RD Signal]

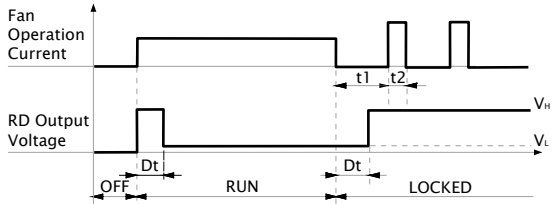

[FG Signal]

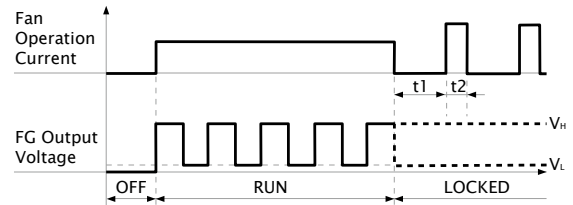
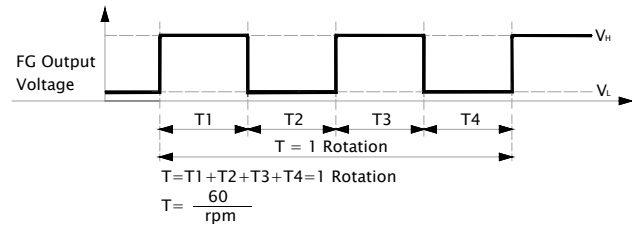

■ PWM Input Signal

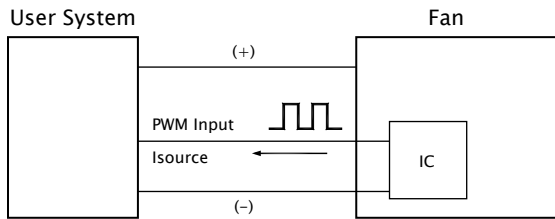

PWM FREQUENCY: 25KHZ
 Isource=0.6mA at PWM Input Voltage 0V
 The speed is default to be maximum if PWM input pin is unconnected.
 Min. start up duty cycle is 20%.

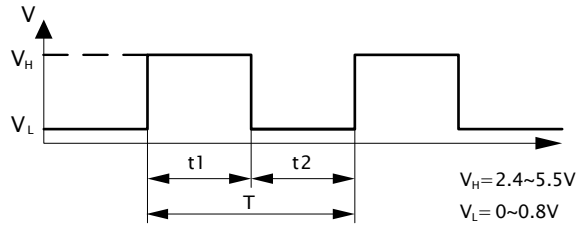

1. Period : $T = \frac{1}{f_{PWM}} = t1 + t2(\text{sec})$
2. Duty Cycle (D.C.) : $\frac{t1}{t1+t2} \times 100 = \frac{t1}{T} \times 100(\%)$

■ PWM Curve

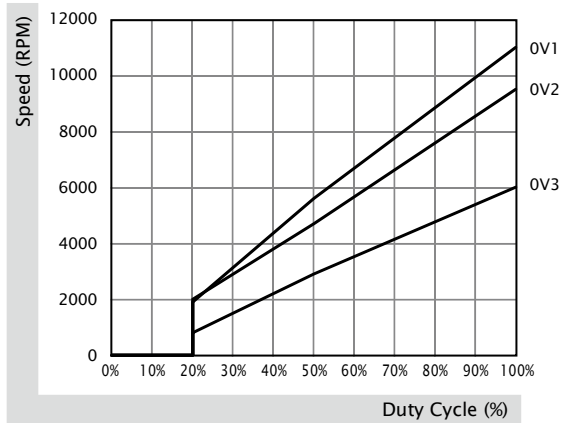

30x30x10 mm

3.5 CFM



■ Specification

	Bearing	Rated Voltage	Power Current	Power Consumption	Speed	Airflow	Static Pressure	Noise	Weight	Curve
	● VAPO	(VDC)	(mA)	(WATTS)	(RPM)	(CFM)	(inch-H ₂ O)	(dB(A))	(g)	
HA30101V3-10000-A99	●	12	25	0.30	7000	3.5	0.10	15.1	7.8	1

■ Function R Type : F99 / F Type : G99

■ Air Flow-Static Pressure Characteristics

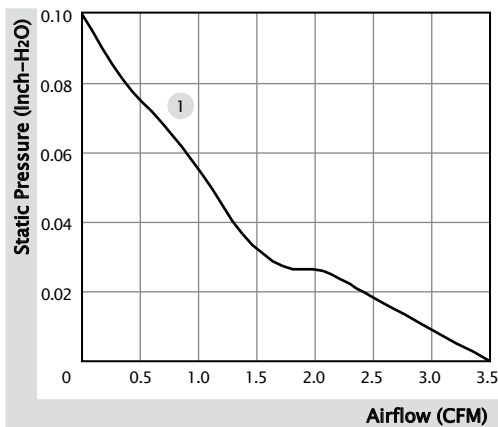

■ External Dimensions(mm)

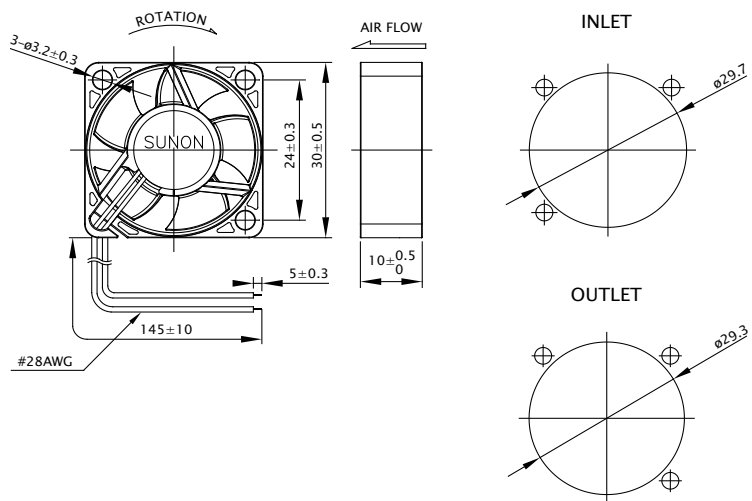

※ All model could be customized. Please contact with Sunon Sales.

※ Specifications are subject to change without notice. Please Visit SUNON website at www.sunon.com for update information.

■ RD / FG Output Signal

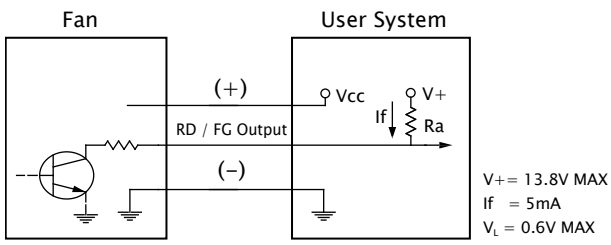

[RD Signal]

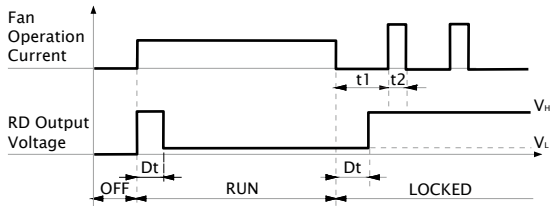

[FG Signal]

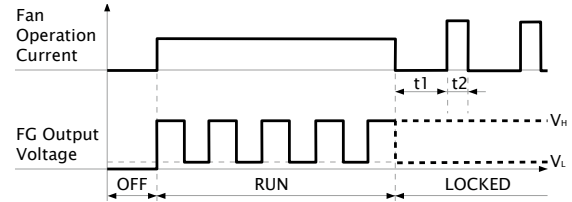
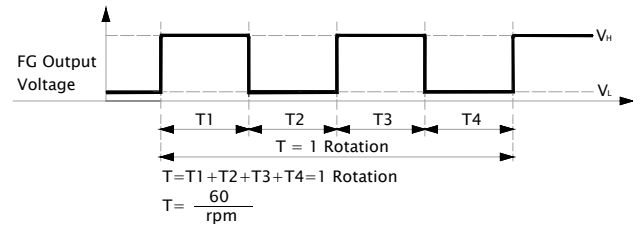

30x30x15 mm

2.7~6.0 CFM

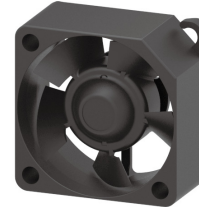

■ Specification

	Bearing	Rated Voltage	Power Current	Power Consumption	Speed	Airflow	Static Pressure	Noise	Weight	Curve
	● VAPO	(VDC)	(mA)	(WATTS)	(RPM)	(CFM)	(inch-H ₂ O)	(dB(A))	(g)	
MF30150V1-10000-A99	●	5	140	0.70	9500	6.0	0.17	27.0	9.7	1
MF30150V2-10000-A99	●	5	80	0.40	7300	4.9	0.12	20.0	9.7	2
MF30150V3-10000-A99	●	5	45	0.23	5200	2.8	0.05	9.8	9.7	3
MF30151V1-10000-A99	●	12	65	0.78	9500	6.0	0.17	27.0	9.7	1
MF30151V2-10000-A99	●	12	35	0.42	7000	4.8	0.12	19.0	9.7	2
MF30151V3-10000-A99	●	12	20	0.24	4600	2.7	0.05	7.8	9.7	3

■ Function (5V) R Type : F99 / F Type : G99 / PWM : H99, Q99, S99
 (12V) R Type : F99 / F Type : G99

■ Air Flow-Static Pressure Characteristics

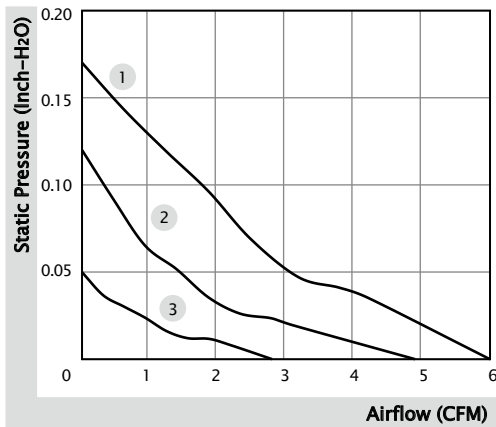

■ External Dimensions(mm)

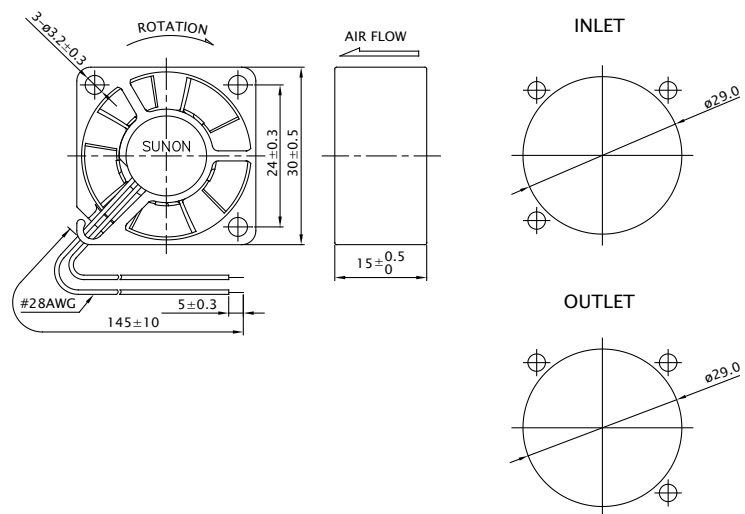

※ All model could be customized. Please contact with Sunon Sales.

※ Specifications are subject to change without notice. Please Visit SUNON website at www.sunon.com for update information.

■ RD / FG Output Signal

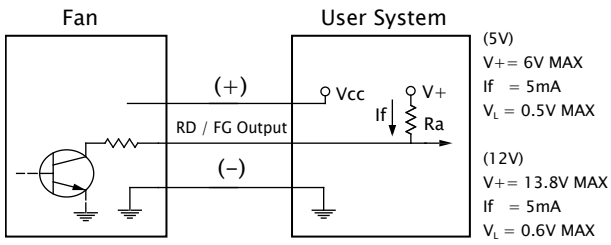

[RD Signal]

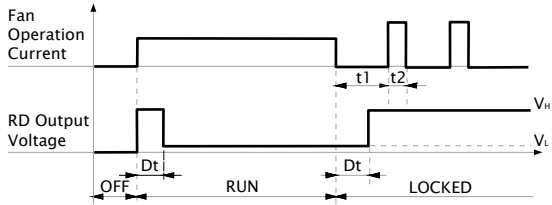

[FG Signal]

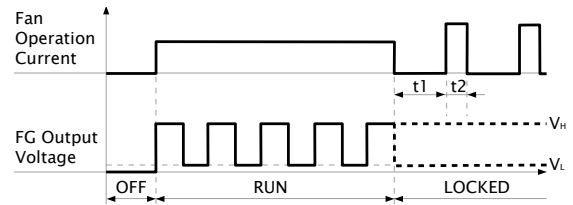
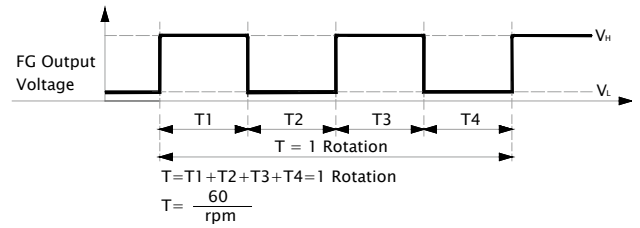

■ PWM Input Signal

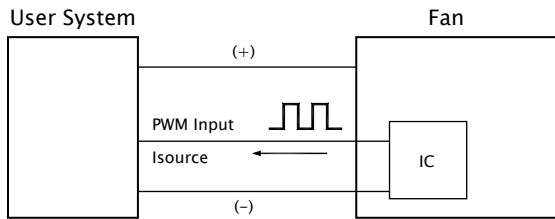

PWM FREQUENCY: 25KHZ
 $I_{\text{source}} = 0.6\text{mA}$ at PWM Input Voltage 0V
 The speed is default to be maximum if PWM input pin is unconnected.
 Min. start up duty cycle is 20%.

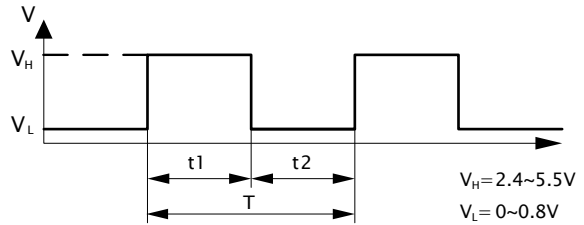

1. Period : $T = \frac{1}{f_{\text{PWM}}} = t_1 + t_2 (\text{sec})$

2. Duty Cycle (D.C.) : $\frac{t_1}{t_1 + t_2} \times 100 = \frac{t_1}{T} \times 100(\%)$

■ PWM Curve

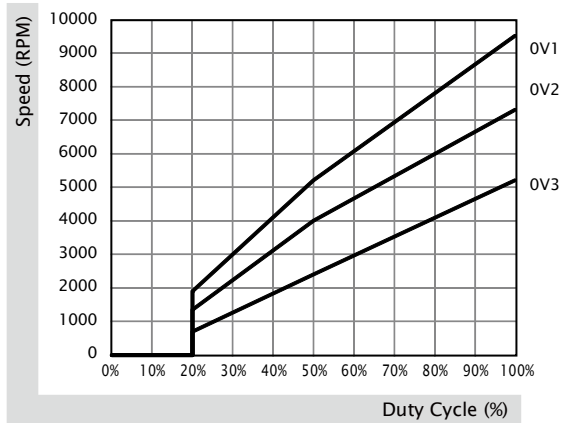

35x35x6 mm

4.3~5.5 CFM



■ Specification

	Bearing	Rated Voltage	Power Current	Power Consumption	Speed	Airflow	Static Pressure	Noise	Weight	Curve
	● VAPO	(VDC)	(mA)	(WATTS)	(RPM)	(CFM)	(inch-H ₂ O)	(dB(A))	(g)	
MF35060V1-10000-A99	●	5	120	0.60	7600	5.5	0.11	26.0	7.0	1
MF35060V2-10000-A99	●	5	66	0.33	5800	4.3	0.07	18.3	7.0	2

■ Function R Type : F99 / F Type : G99 / PWM : H99, Q99, S99

■ Air Flow-Static Pressure Characteristics

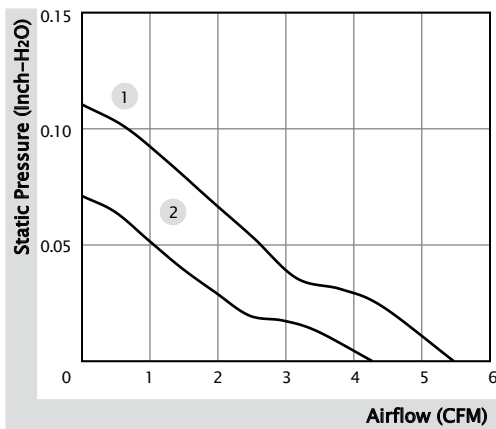

■ External Dimensions(mm)

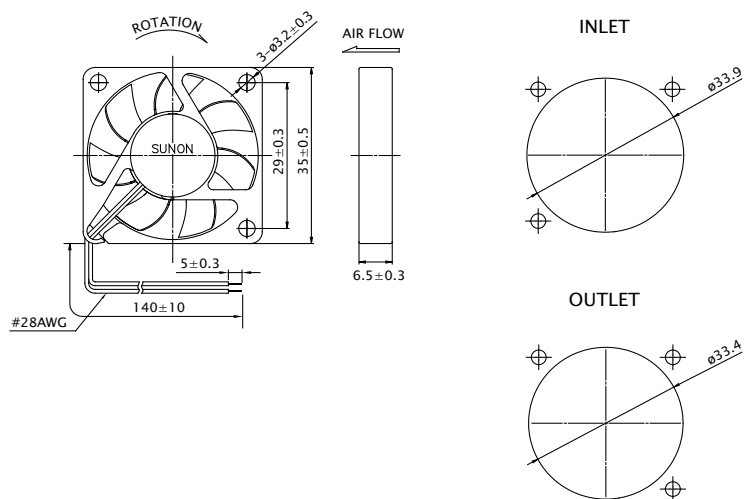

* All model could be customized. Please contact with Sunon Sales.

* Specifications are subject to change without notice. Please Visit SUNON website at www.sunon.com for update information.

■ RD / FG Output Signal

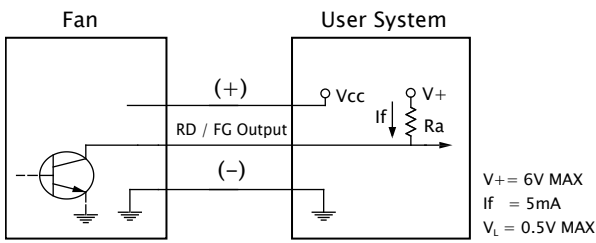

[RD Signal]

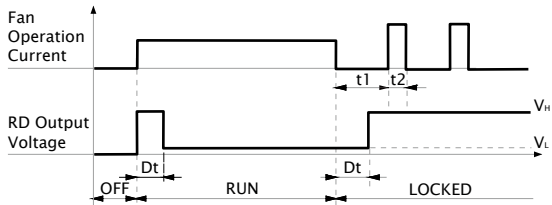

[FG Signal]

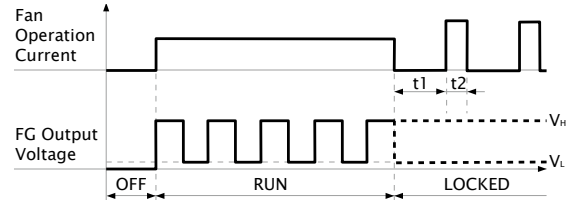
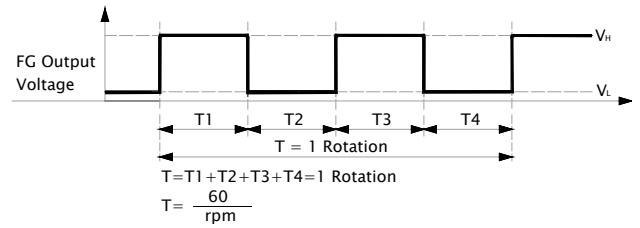

■ PWM Input Signal

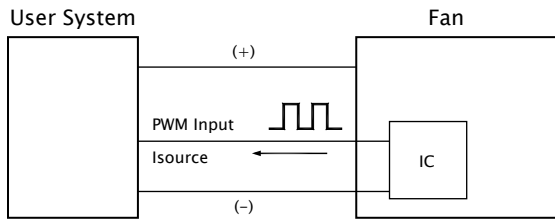

PWM FREQUENCY: 25KHZ

Isource=0.6mA at PWM Input Voltage 0V

The speed is default to be maximum if PWM input pin is unconnected.
Min. start up duty cycle is 20%.

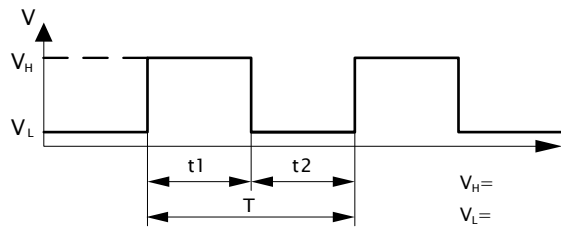

1. Period : $T = \frac{1}{f_{PWM}} = t1 + t2(\text{sec})$

2. Duty Cycle (D.C.) : $\frac{t1}{t1+t2} \times 100 = \frac{t1}{T} \times 100(\%)$

■ PWM Curve

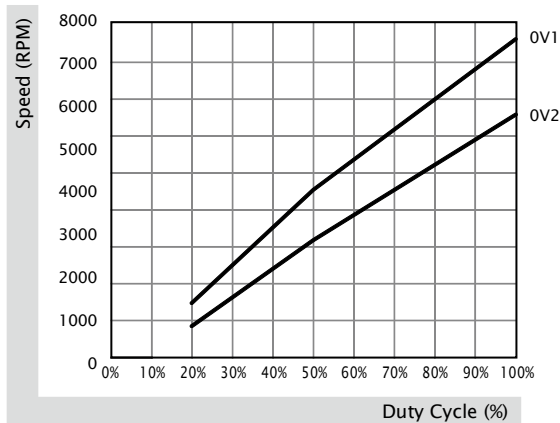

35x35x10 mm

3.6~7.2 CFM



■ Specification

	Bearing	Rated Voltage	Power Current	Power Consumption	Speed	Airflow	Static Pressure	Noise	Weight	Curve
	● VAPO	(VDC)	(mA)	(WATTS)	(RPM)	(CFM)	(inch-H ₂ O)	(dB(A))	(g)	
MF35100V1-10000-A99	●	5	135	0.68	10000	7.2	0.22	28.0	10.5	1
MF35100V2-10000-A99	●	5	80	0.40	7500	6.5	0.13	21.8	10.5	2
MF35100V3-10000-A99	●	5	45	0.23	5300	3.7	0.07	13.1	10.5	3
MF35101V1-10000-A99	●	12	60	0.72	10000	7.2	0.22	28.0	10.5	1
MF35101V2-10000-A99	●	12	35	0.42	7500	6.5	0.13	21.8	10.5	2
MF35101V3-10000-A99	●	12	20	0.24	5000	3.6	0.07	12.0	10.5	3

■ Function (5V) R Type : F99 / F Type : G99 / PWM : H99, Q99, S99
 (12V) R Type : F99 / F Type : G99

■ Air Flow-Static Pressure Characteristics

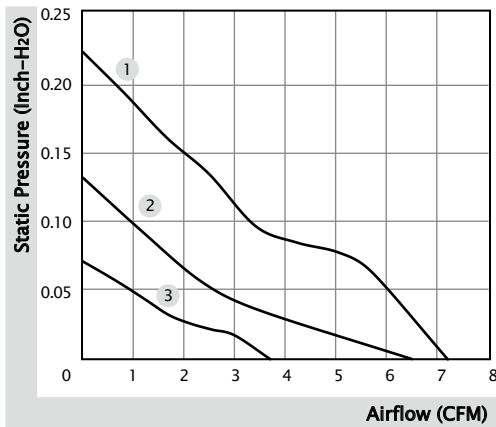

■ External Dimensions(mm)

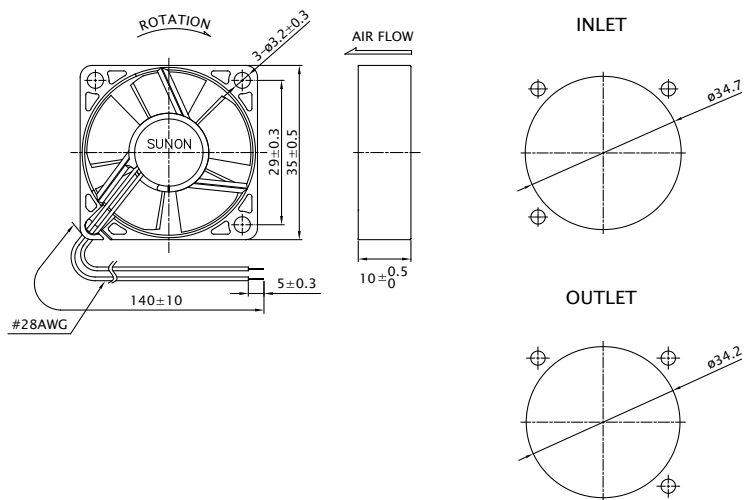

※ All model could be customized. Please contact with Sunon Sales.

※ Specifications are subject to change without notice. Please Visit SUNON website at www.sunon.com for update information.

■ RD / FG Output Signal

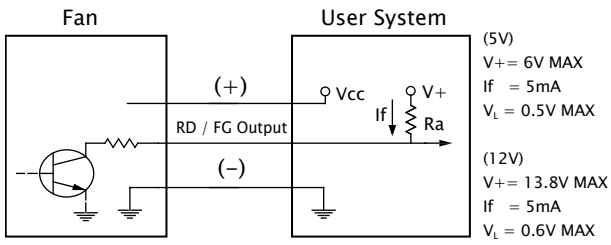

[RD Signal]

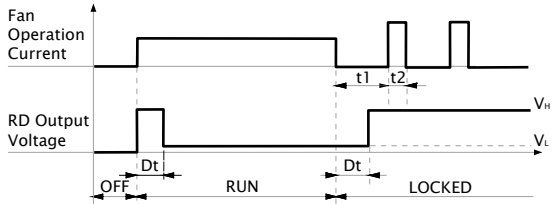

[FG Signal]

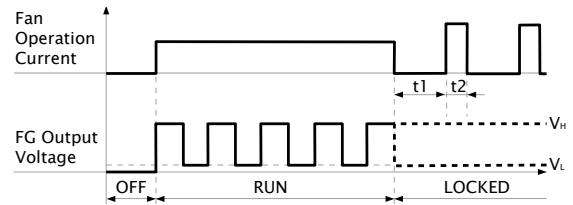
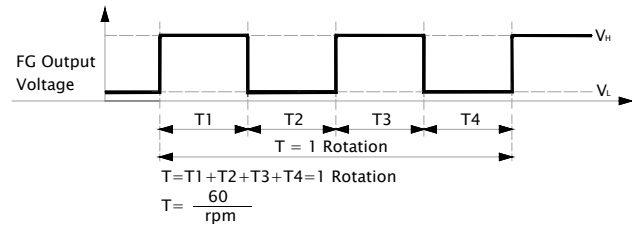

■ PWM Input Signal

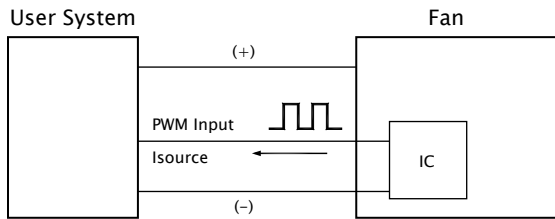

PWM FREQUENCY: 25KHZ
 $I_{\text{source}} = 0.6\text{mA}$ at PWM Input Voltage 0V
 The speed is default to be maximum if PWM input pin is unconnected.
 Min. start up duty cycle is 20%.

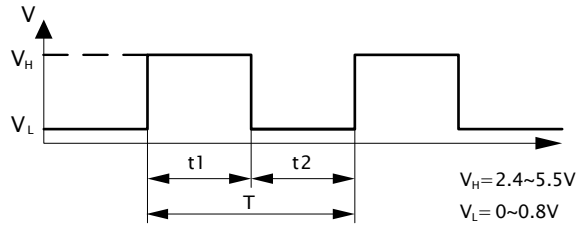

1. Period : $T = \frac{1}{f_{\text{PWM}}} = t_1 + t_2 (\text{sec})$

2. Duty Cycle (D.C.) : $\frac{t_1}{t_1 + t_2} \times 100 = \frac{t_1}{T} \times 100(\%)$

■ PWM Curve

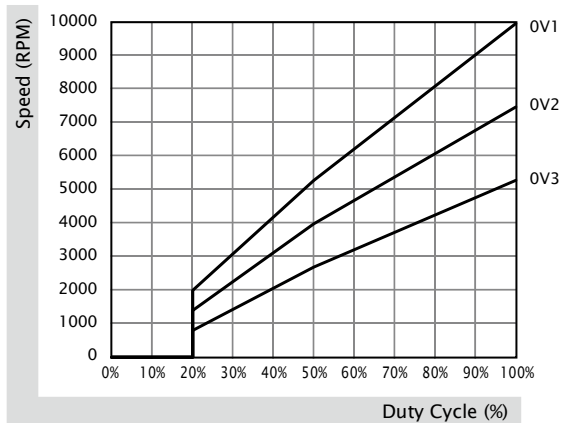

36x36x28 mm

18.1~22.8 CFM

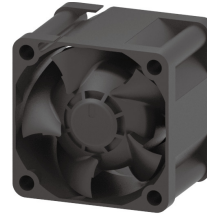

■ Specification

Model	Bearing	Rated Voltage	Power Current	Power Consumption	Speed	Airflow	Static Pressure	Noise	Weight	Curve
	2BALL Sleeve	(VDC)	(mA)	(WATTS)	(RPM)	(CFM)	(inch-H ₂ O)	(dB(A))	(g)	
PF36281BX-0000-A99	☉	12	800	9.60	23000	22.8	2.55	61.9	40.5	1
PF36281B1-0000-A99	☉	12	450	5.40	18400	18.1	1.62	55.7	40.5	2

■ Function R Type : F99 / F Type : G99 / PWM : H99, Q99, S99

■ Air Flow-Static Pressure Characteristics

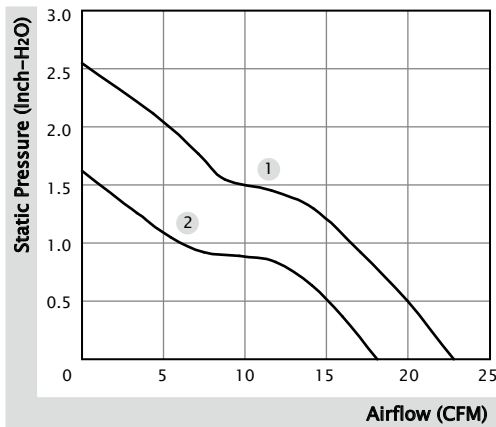

■ External Dimensions(mm)

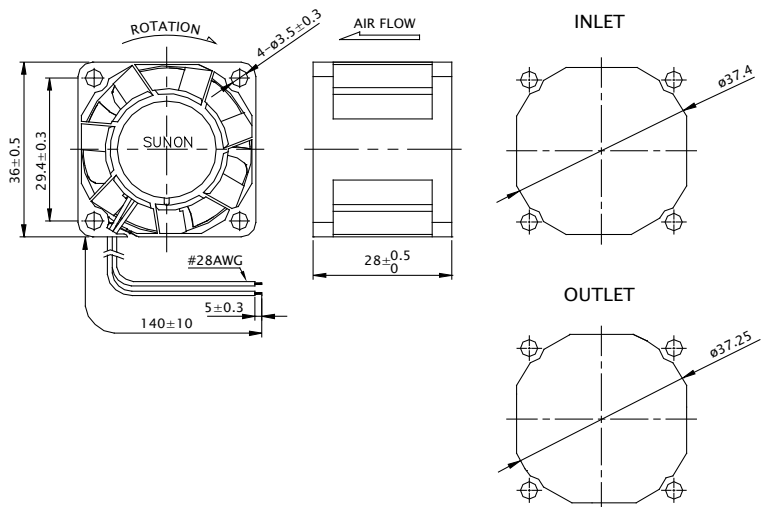

※ All model could be customized. Please contact with Sunon Sales.

※ Specifications are subject to change without notice. Please Visit SUNON website at www.sunon.com for update information.

■ RD / FG Output Signal

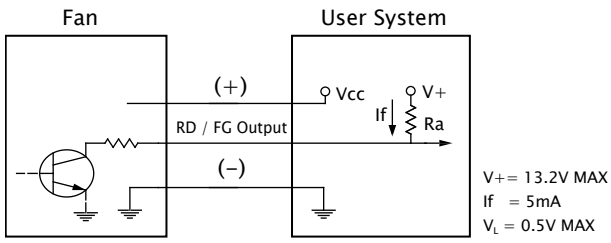

[RD Signal]

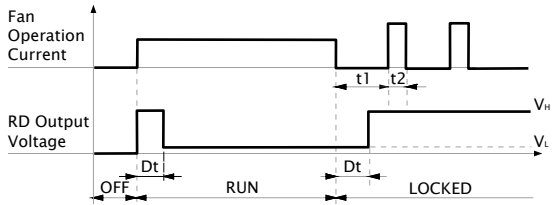

[FG Signal]

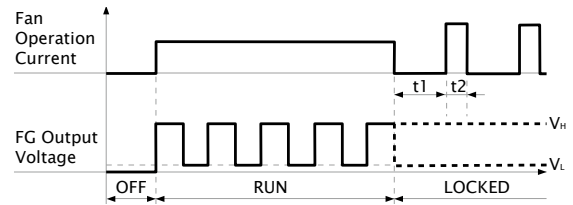
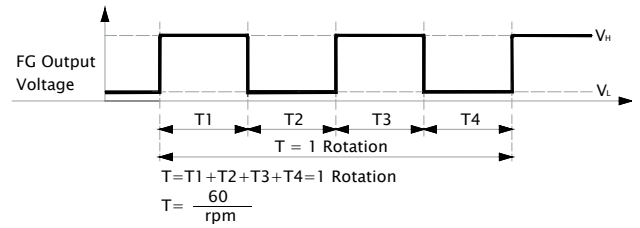

■ PWM Input Signal

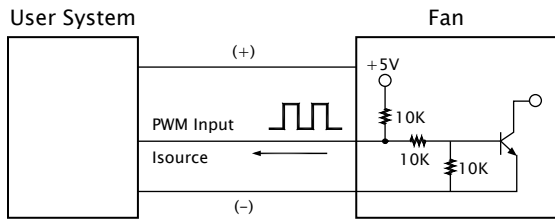

PWM FREQUENCY: 25KHZ
 Isource=0.5mA at PWM Input Voltage 0V
 The speed is default to be maximum if PWM input pin is unconnected.
 Min. start up duty cycle is 10%.

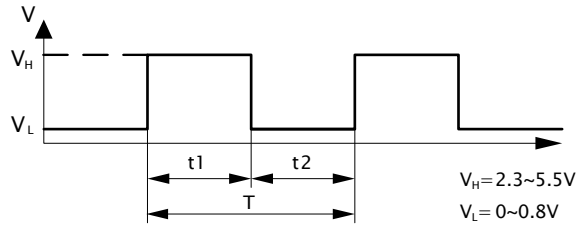

1. Period : $T = \frac{1}{f_{PWM}} = t1 + t2(\text{sec})$
2. Duty Cycle (D.C.) : $\frac{t1}{t1+t2} \times 100 = \frac{t1}{T} \times 100(\%)$

■ PWM Curve

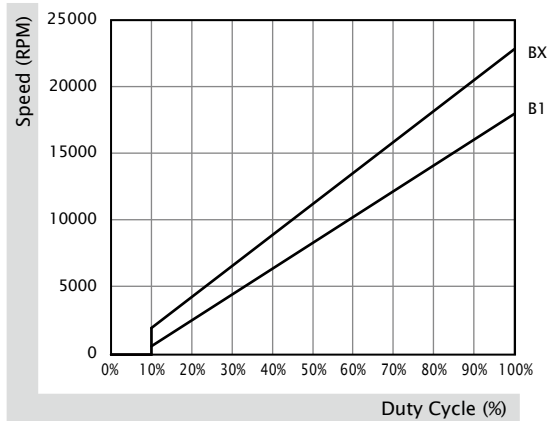

38x38x28 mm

18.9~24.2 CFM

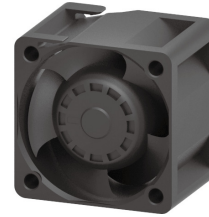

■ Specification

Model	Bearing	Rated Voltage	Power Current	Power Consumption	Speed	Airflow	Static Pressure	Noise	Weight	Curve
	2BALL Sleeve	(VDC)	(mA)	(WATTS)	(RPM)	(CFM)	(inch-H ₂ O)	(dB(A))	(g)	
VF38281BX-0000-A9H	☉	12	870	10.44	27000	24.2	3.56	61.6	44.0	1
VF38281B1-0000-A9H	☉	12	475	5.70	21600	18.9	2.50	58.1	44.0	2

■ Function F Type : G9H / PWM : S9H

■ Air Flow-Static Pressure Characteristics

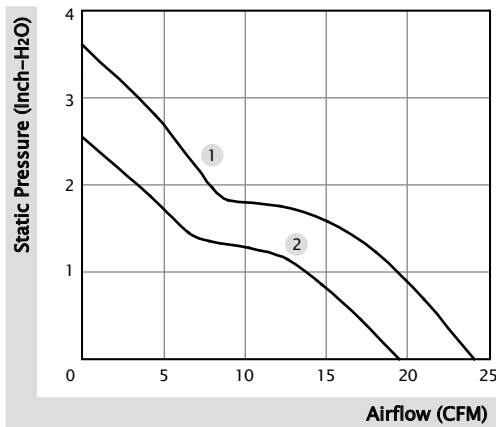

■ External Dimensions(mm)

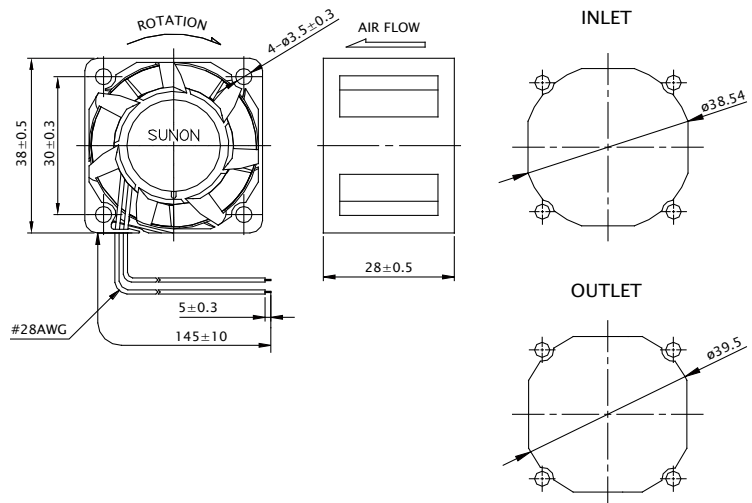

※ All model could be customized. Please contact with Sunon Sales.

※ Specifications are subject to change without notice. Please Visit SUNON website at www.sunon.com for update information.

■ FG Output Signal

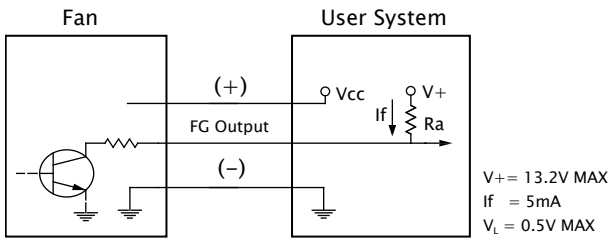

[FG Signal]

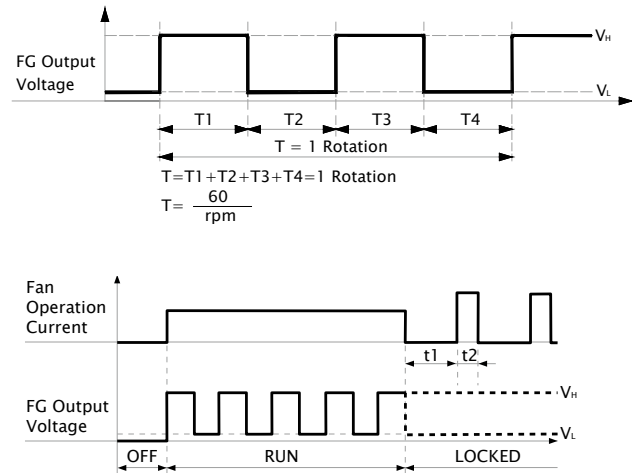

■ PWM Input Signal

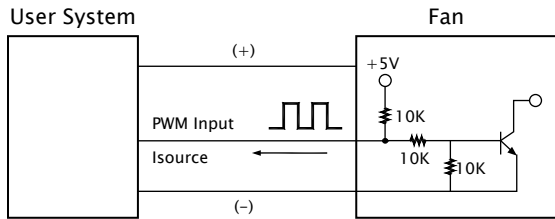

PWM FREQUENCY: 25KHZ
 $I_{source} = 0.5mA$ at PWM Input Voltage 0V
 The speed is default to be maximum if PWM input pin is unconnected.
 Min. start up duty cycle is 10%.

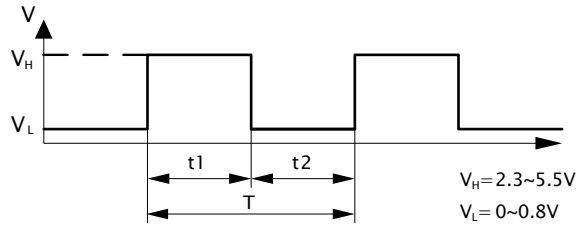

1. Period : $T = \frac{1}{f_{PWM}} = t_1 + t_2 (\text{sec})$

2. Duty Cycle (D.C.) : $\frac{t_1}{t_1 + t_2} \times 100 = \frac{t_1}{T} \times 100(\%)$

■ PWM Curve

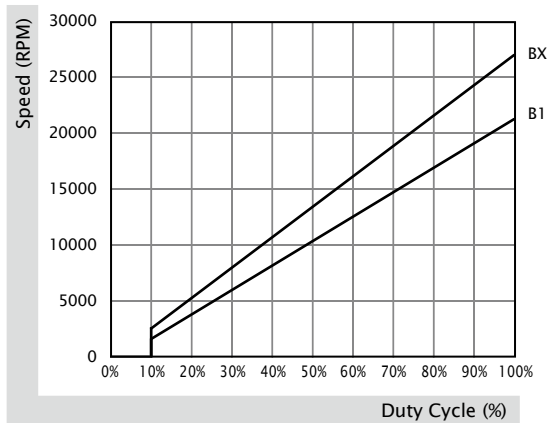

38x38x28 mm

11.3~23.0 CFM

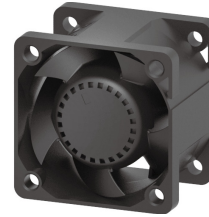

■ Specification

Model	Bearing	Rated Voltage	Power Current	Power Consumption	Speed	Airflow	Static Pressure	Noise	Weight	Curve
	2BALL Sleeve	(VDC)	(mA)	(WATTS)	(RPM)	(CFM)	(inch-H ₂ O)	(dB(A))	(g)	
PF38281BX-10000-A9H	☉	12	570	6.84	20000	23.0	2.26	57.0	41.0	1
PF38281B1-10000-A9H	☉	12	315	3.78	16000	18.1	1.54	51.8	41.0	2
PF38281B2-10000-A9H	☉	12	265	3.18	15000	16.9	1.30	51.0	41.0	3
PF38281B3-10000-A9H	☉	12	180	2.16	13000	14.9	1.03	47.3	41.0	4
PF38281B4-10000-A9H	☉	12	95	1.14	10000	11.3	0.62	40.8	41.0	5

■ Function R Type : F9H / F Type : G9H / PWM : H9H, Q9H, S9H

■ Air Flow-Static Pressure Characteristics

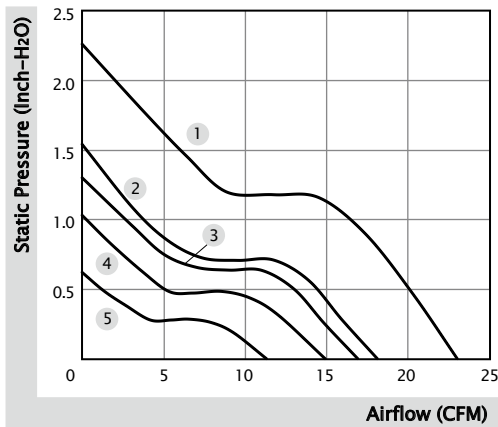

■ External Dimensions(mm)

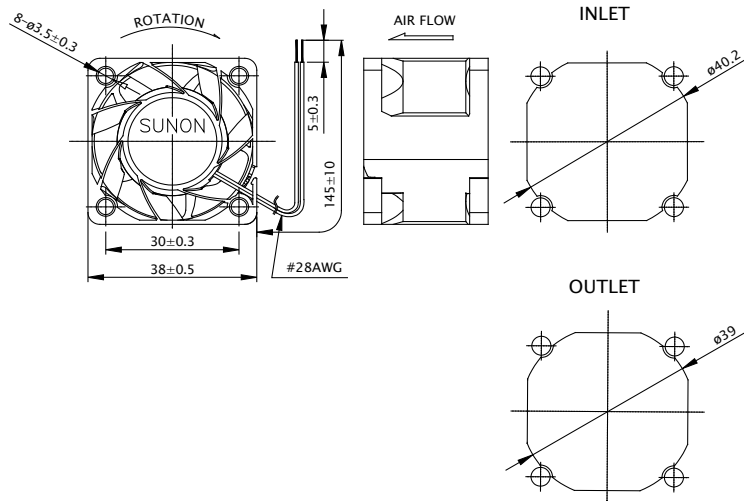

※ All model could be customized. Please contact with Sunon Sales.

※ Specifications are subject to change without notice. Please Visit SUNON website at www.sunon.com for update information.

■ RD / FG Output Signal

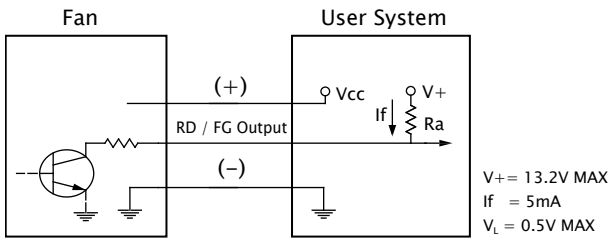

[RD Signal]

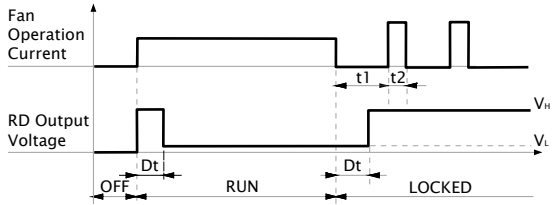

[FG Signal]

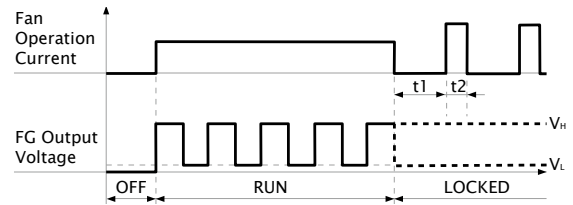
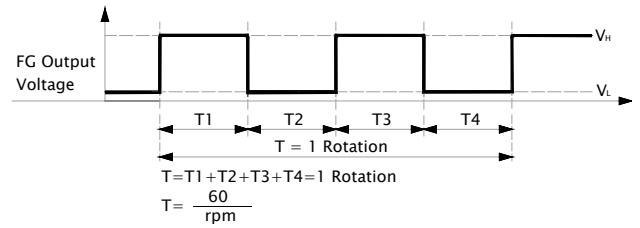

■ PWM Input Signal

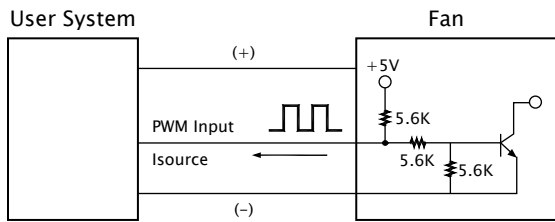

PWM FREQUENCY: 25KHZ
 Isource=0.5mA at PWM Input Voltage 0V
 The speed is default to be maximum if PWM input pin is unconnected.
 Min. start up duty cycle is 10%.

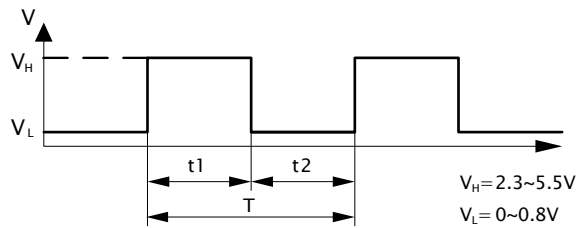

1. Period : $T = \frac{1}{f_{PWM}} = t1 + t2(\text{sec})$

2. Duty Cycle (D.C.) : $\frac{t1}{t1+t2} \times 100 = \frac{t1}{T} \times 100(\%)$

■ PWM Curve

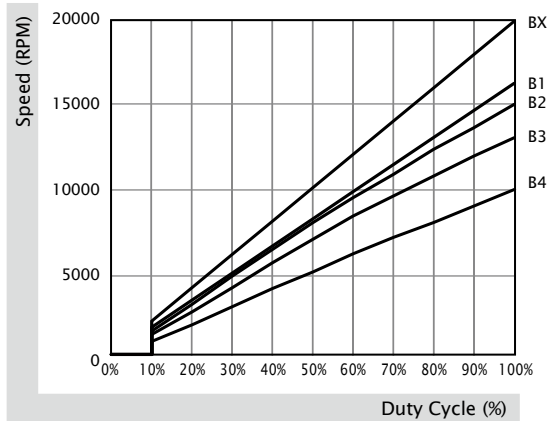

38x38x28 mm

18.1 CFM

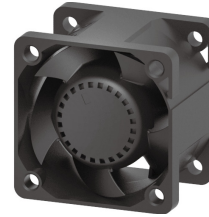

■ Specification

	Bearing	Rated Voltage	Power Current	Power Consumption	Speed	Airflow	Static Pressure	Noise	Weight	Curve
	● VAPO	(VDC)	(mA)	(WATTS)	(RPM)	(CFM)	(inch-H ₂ O)	(dB(A))	(g)	
PF38281V1-0000-A99	●	12	574	6.89	16000	18.1	1.42	51.8	43.0	1

■ Function F Type : G99 / PWM : S99

■ Air Flow-Static Pressure Characteristics



■ External Dimensions(mm)

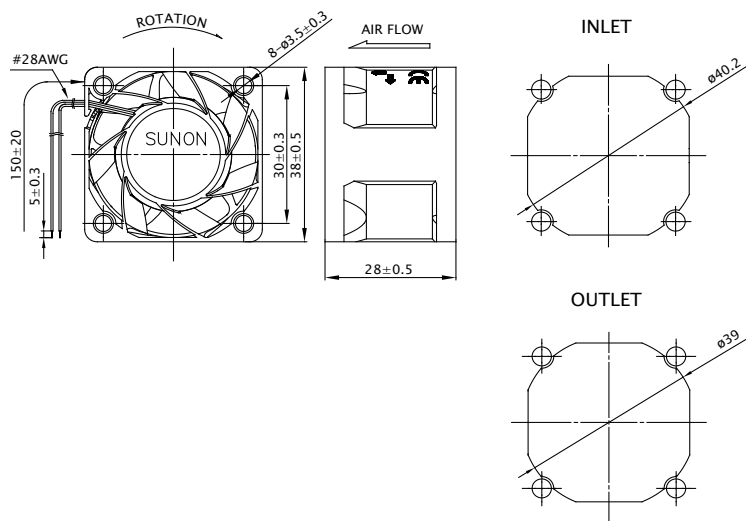

※ All model could be customized. Please contact with Sunon Sales.

※ Specifications are subject to change without notice. Please Visit SUNON website at www.sunon.com for update information.

■ FG Output Signal

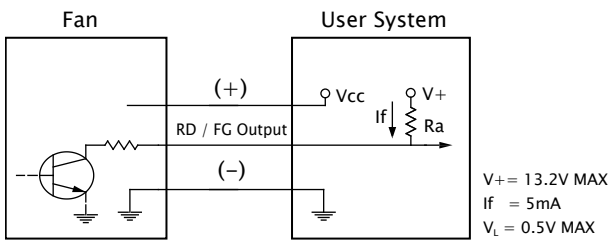

[FG Signal]

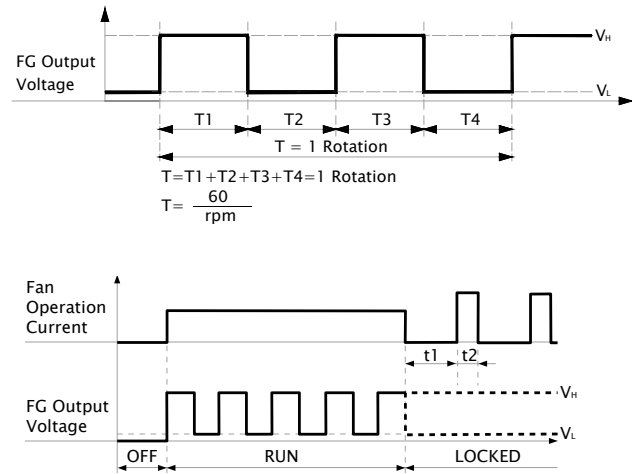

■ PWM Input Signal

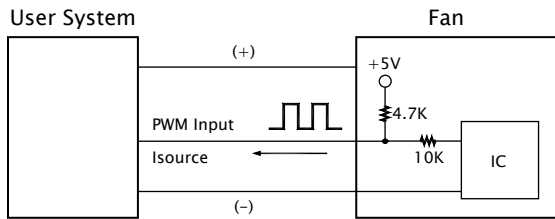

PWM FREQUENCY: 25KHZ
 Isource=0.5mA at PWM Input 0V
 The speed is default to be maximum if PWM input pin is unconnected.
 Min. start up duty cycle is 10%.

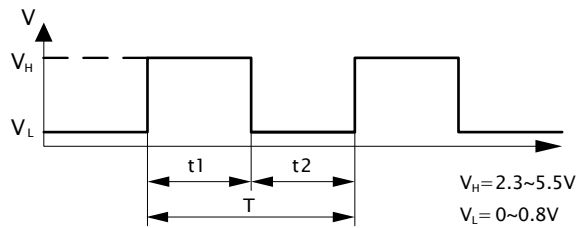

1. Period : $T = \frac{1}{f_{PWM}} = t1 + t2(\text{sec})$
2. Duty Cycle (D.C.) : $\frac{t1}{t1+t2} \times 100 = \frac{t1}{T} \times 100(\%)$

■ PWM Curve

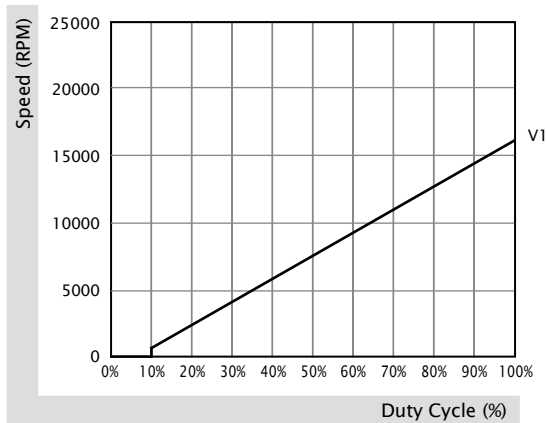

38x38x56 mm

31.2 CFM

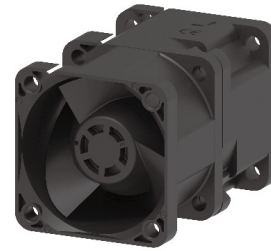

■ Specification

Model	Bearing	Rated Voltage	Power Current	Power Consumption	Speed	Airflow	Static Pressure	Noise	Weight	Curve
	2BALL Sleeve	(VDC)	(mA)	(WATTS)	(RPM)	(CFM)	(inch-H ₂ O)	(dB(A))	(g)	
VF38561BX-10000-A9T	☉	12	1200	14.40	29300	31.2	4.60	61.6	66.0	1

■ Function F Type : G9T / PWM : S9T

■ Air Flow-Static Pressure Characteristics

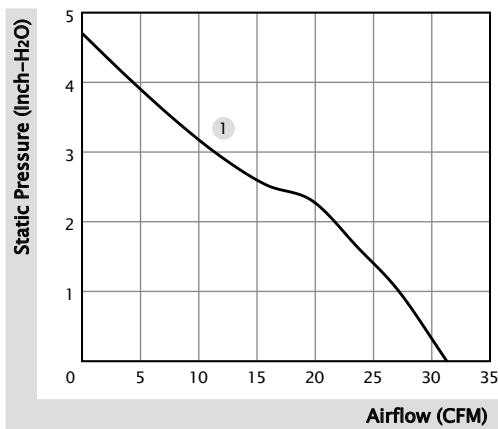

■ External Dimensions(mm)

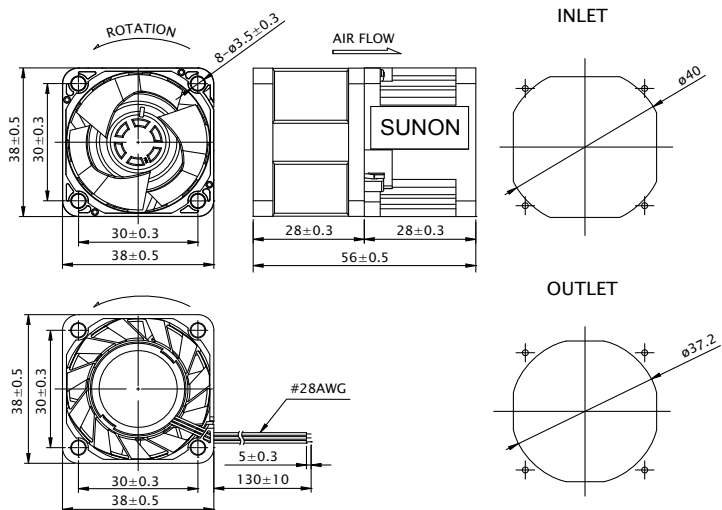

※ All model could be customized. Please contact with Sunon Sales.

※ Specifications are subject to change without notice. Please Visit SUNON website at www.sunon.com for update information.

■ FG Output Signal

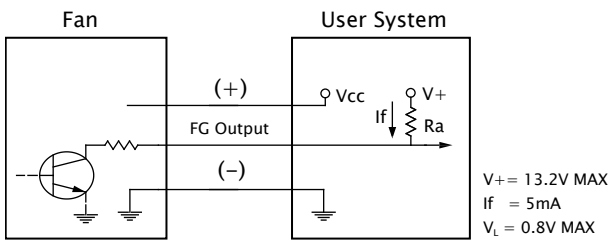

[FG Signal]

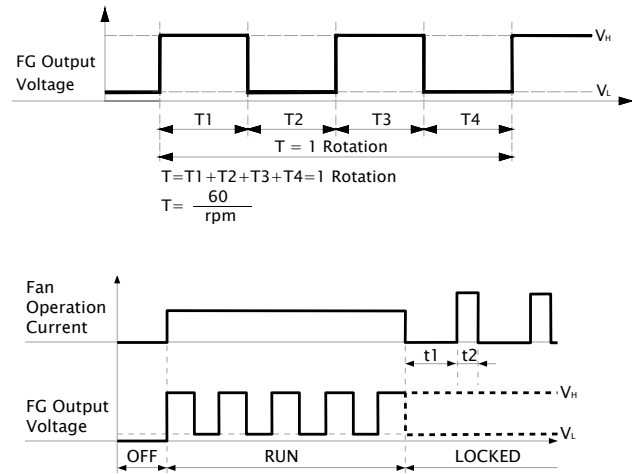

■ PWM Input Signal

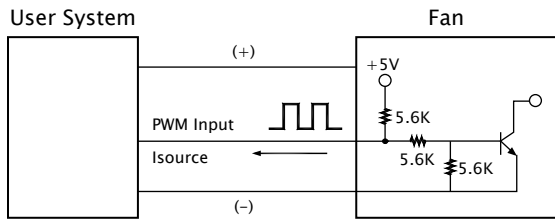

PWM FREQUENCY: 25KHZ
 Isource=1.0mA at PWM Input Voltage 0V
 The speed is default to be maximum if PWM input pin is unconnected.
 Min. start up duty cycle is 10%.

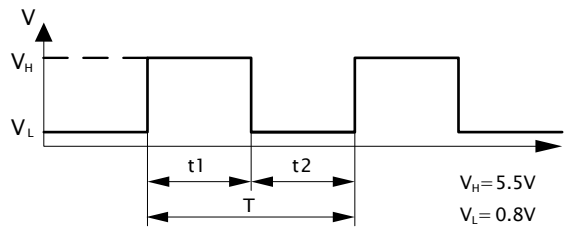

1. Period : $T = \frac{1}{f_{PWM}} = t1 + t2(\text{sec})$
2. Duty Cycle (D.C.) : $\frac{t1}{t1+t2} \times 100 = \frac{t1}{T} \times 100(\%)$

■ PWM Curve

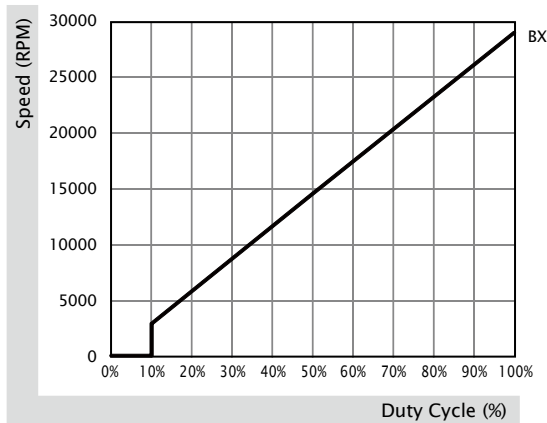

40x40x6 mm

5.5~6.3 CFM

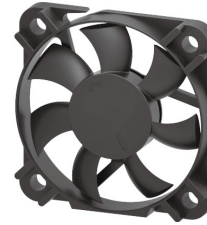

■ Specification

	Bearing	Rated Voltage	Power Current	Power Consumption	Speed	Airflow	Static Pressure	Noise	Weight	Curve
	● VAPO	(VDC)	(mA)	(WATTS)	(RPM)	(CFM)	(inch-H ₂ O)	(dB(A))	(g)	
MF40060V1-10000-A99	●	5	87	0.44	7000	6.3	0.10	29.3	6.8	1
MF40060V2-10000-A99	●	5	65	0.33	6000	5.5	0.08	25.3	6.8	2

■ Function R Type : F99 / F Type : G99 / PWM : H99, Q99, S99

■ Air Flow-Static Pressure Characteristics

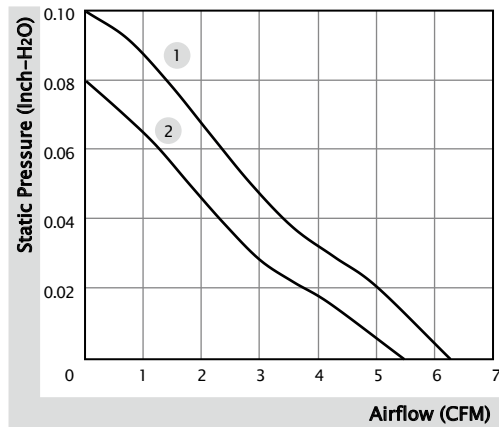

■ External Dimensions(mm)

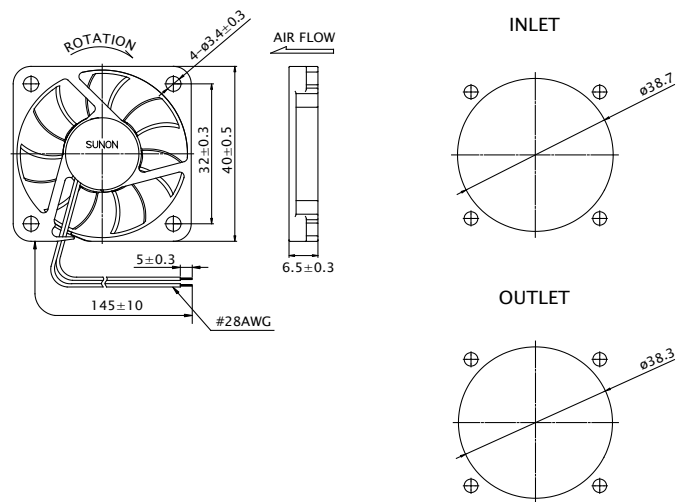

※ All model could be customized. Please contact with Sunon Sales.

※ Specifications are subject to change without notice. Please Visit SUNON website at www.sunon.com for update information.

■ RD / FG Output Signal

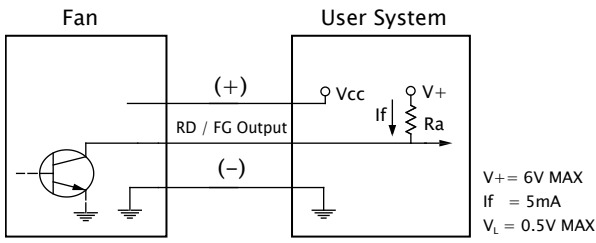

[RD Signal]

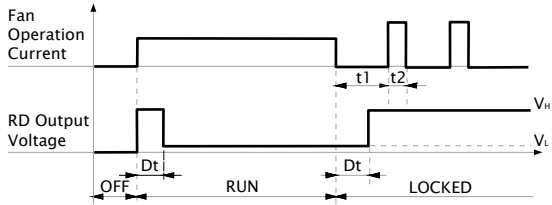

[FG Signal]

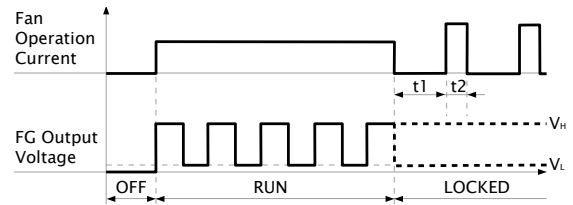
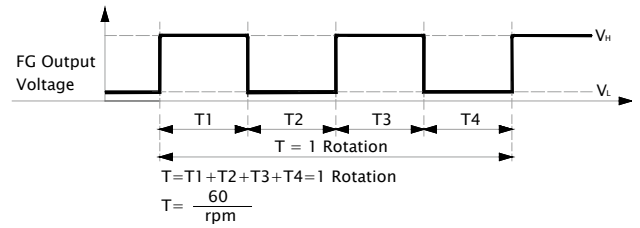

■ PWM Input Signal

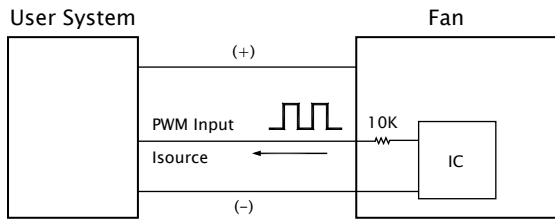

PWM FREQUENCY: 25KHZ

Isource=0.5mA at PWM Input Voltage 0V

The speed is default to be maximum if PWM input pin is unconnected.

Min. start up duty cycle is 20%.

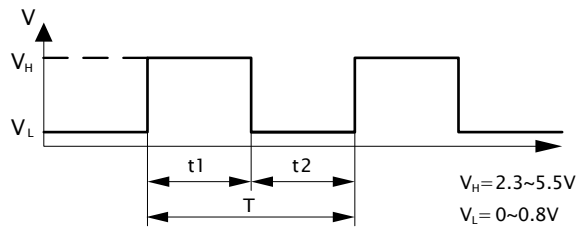

1. Period : $T = \frac{1}{f_{PWM}} = t1 + t2(\text{sec})$

2. Duty Cycle (D.C.) : $\frac{t1}{t1+t2} \times 100 = \frac{t1}{T} \times 100(\%)$

■ PWM Curve

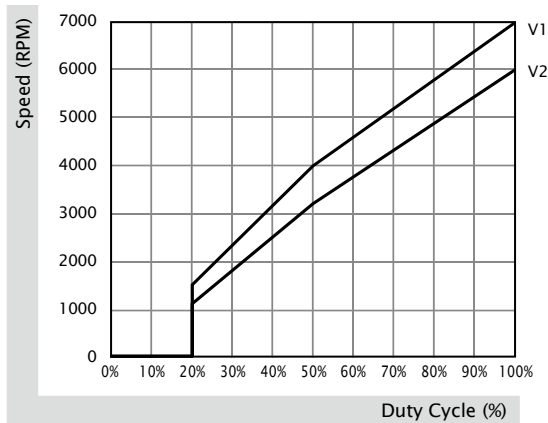

40x40x10 mm

7.0~9.9 CFM



■ Specification

	Bearing	Rated Voltage	Power Current	Power Consumption	Speed	Airflow	Static Pressure	Noise	Weight	Curve
	● VAPO	(VDC)	(mA)	(WATTS)	(RPM)	(CFM)	(inch-H ₂ O)	(dB(A))	(g)	
MF40100V1-10000-A99	●	5	136	0.68	7000	8.0	0.19	27.3	15.6	2
MF40100V2-10000-A99	●	5	94	0.47	5800	7.0	0.12	20.6	15.6	3
MF40101VX-10000-A99	●	12	87	1.05	8500	9.9	0.25	31.4	15.6	1
MF40101V1-10000-A99	●	12	51	0.62	7000	8.0	0.19	27.3	15.6	2
MF40101V2-10000-A99	●	12	40	0.48	5800	7.0	0.12	20.6	15.6	3

■ Function R Type : F99 / F Type : G99

■ Air Flow-Static Pressure Characteristics

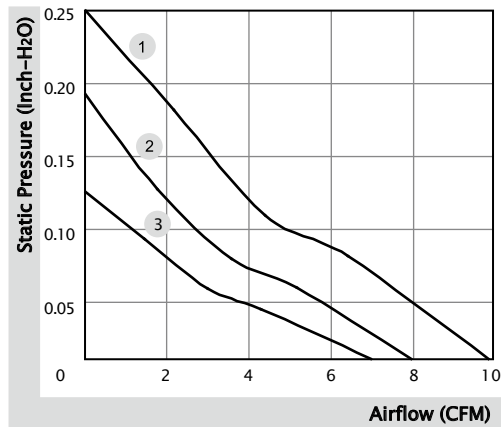

■ External Dimensions(mm)

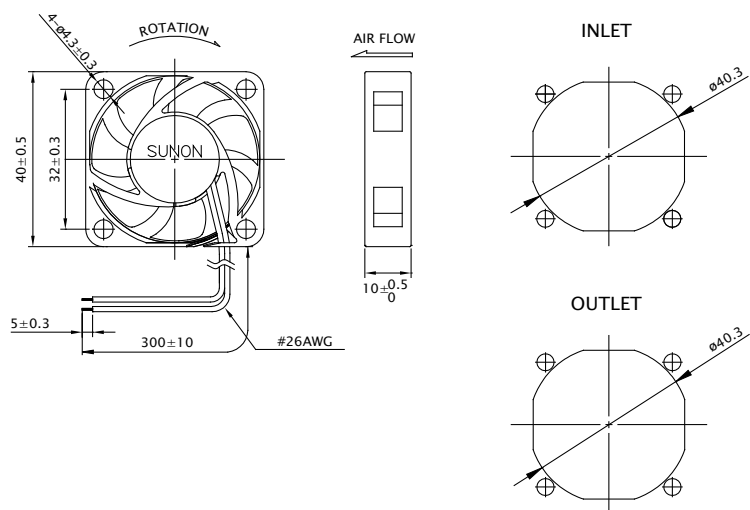

* All model could be customized. Please contact with Sunon Sales.

* Specifications are subject to change without notice. Please Visit SUNON website at www.sunon.com for update information.

■ RD / FG Output Signal

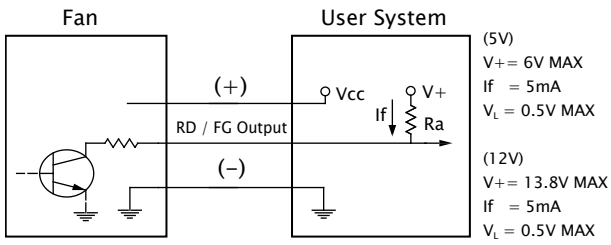

[RD Signal]

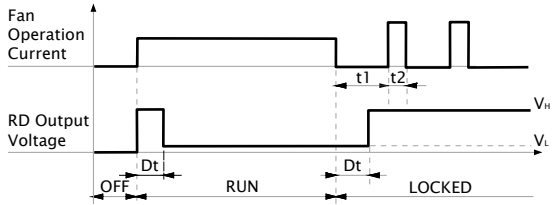

[FG Signal]

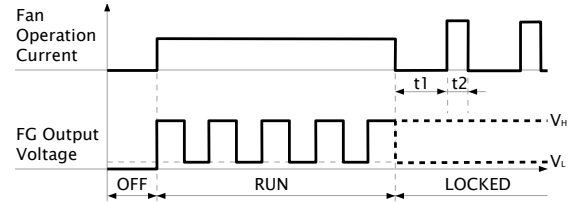
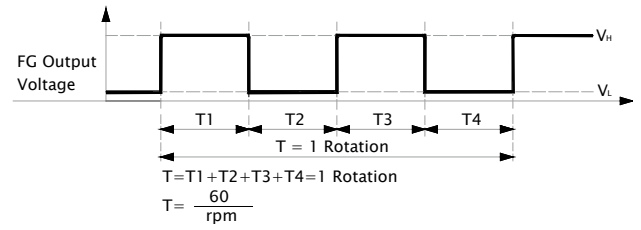

40x40x10 mm

5.5~10.0 CFM



■ Specification

Model	Bearing	Rated Voltage	Power Current	Power Consumption	Speed	Airflow	Static Pressure	Noise	Weight	Curve
	2BALL Sleeve	(VDC)	(mA)	(WATTS)	(RPM)	(CFM)	(inch-H ₂ O)	(dB(A))	(g)	
EF40101BX-10000-A99	☉	12	122	1.47	9000	10.0	0.27	33.7	15.8	1
EF40101B1-10000-A99	☉	12	82	0.99	7000	8.0	0.19	27.3	15.8	2
EF40101B2-10000-A99	☉	12	37	0.45	5000	5.5	0.10	17.7	15.8	3

■ Function R Type : F99 / F Type : G99

■ Air Flow-Static Pressure Characteristics

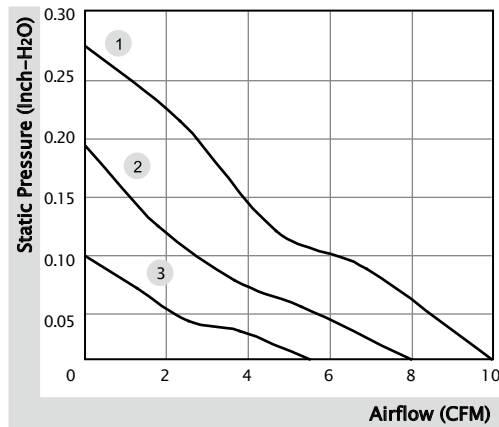

■ External Dimensions(mm)

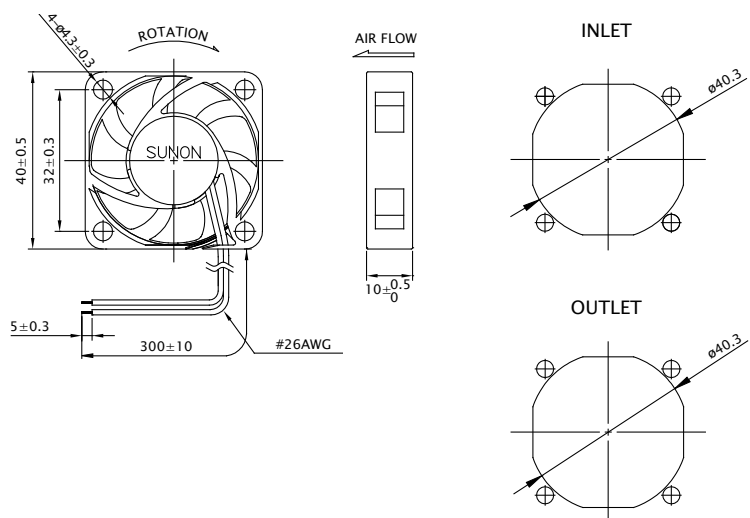

* All model could be customized. Please contact with Sunon Sales.

* Specifications are subject to change without notice. Please Visit SUNON website at www.sunon.com for update information.

■ RD / FG Output Signal

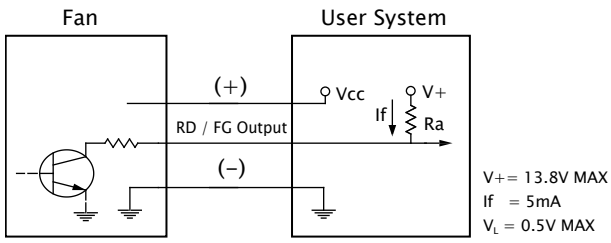

[RD Signal]

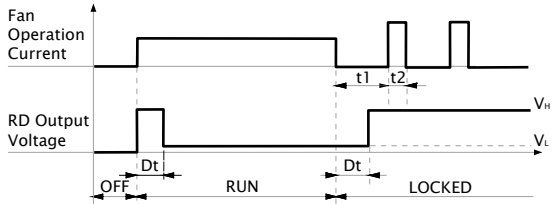

[FG Signal]

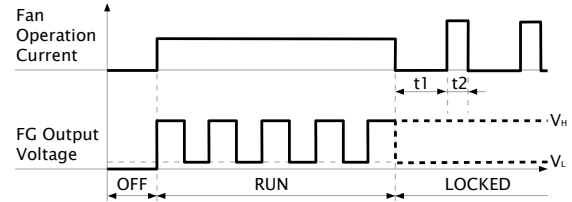
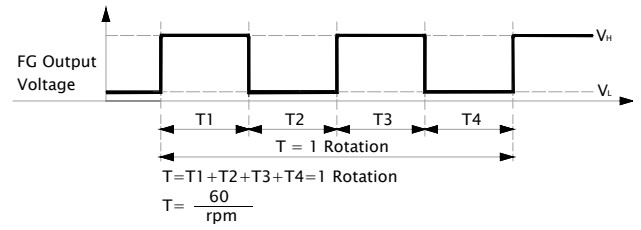

40x40x10 mm

7.1~8.2 CFM



■ Specification

Model	Bearing	Rated Voltage	Power Current	Power Consumption	Speed	Airflow	Static Pressure	Noise	Weight	Curve
	2BALL Sleeve	(VDC)	(mA)	(WATTS)	(RPM)	(CFM)	(inch-H ₂ O)	(dB(A))	(g)	
EE40100S1-10000-999	○	5	172	0.86	7300	8.2	0.19	28.2	15.6	1
EE40100S2-10000-999	○	5	120	0.60	6100	7.1	0.12	23.0	15.6	2
EE40101S1-10000-999	○	12	82	0.99	7300	8.2	0.19	28.2	15.6	1
EE40101S2-10000-999	○	12	68	0.82	6100	7.1	0.12	23.0	15.6	2

■ Function F Type : C99

■ Air Flow-Static Pressure Characteristics

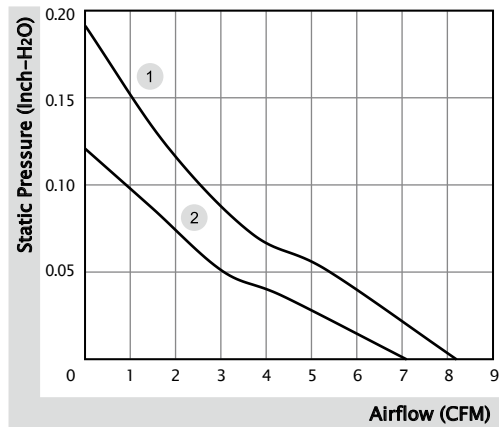

■ External Dimensions(mm)

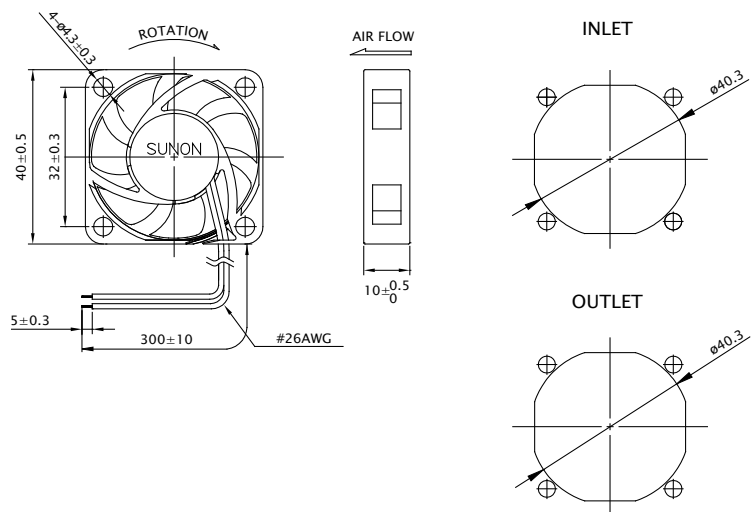

* All model could be customized. Please contact with Sunon Sales.

* Specifications are subject to change without notice. Please Visit SUNON website at www.sunon.com for update information.

■ RD / FG Output Signal

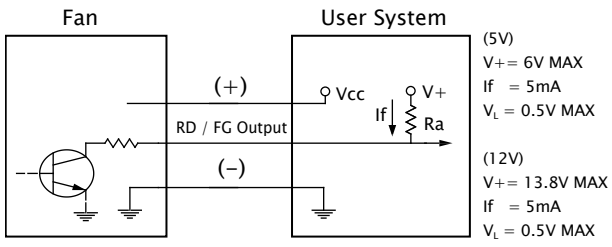

[FG Signal]

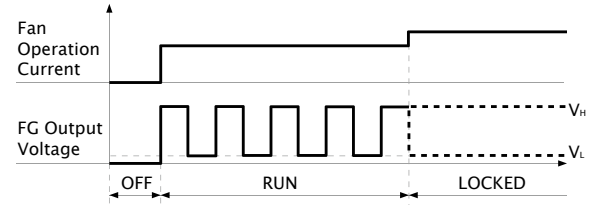
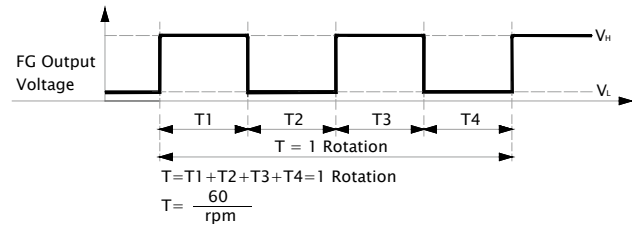

40x40x10 mm

5.4 CFM



■ Specification

	Bearing	Rated Voltage	Power Current	Power Consumption	Speed	Airflow	Static Pressure	Noise	Weight	Curve
	● VAPO	(VDC)	(mA)	(WATTS)	(RPM)	(CFM)	(inch-H ₂ O)	(dB(A))	(g)	
HA40101V4-10000-A99	●	12	31	0.38	5000	5.4	0.09	15.7	15.4	1

■ Function F Type : G99

■ Air Flow-Static Pressure Characteristics

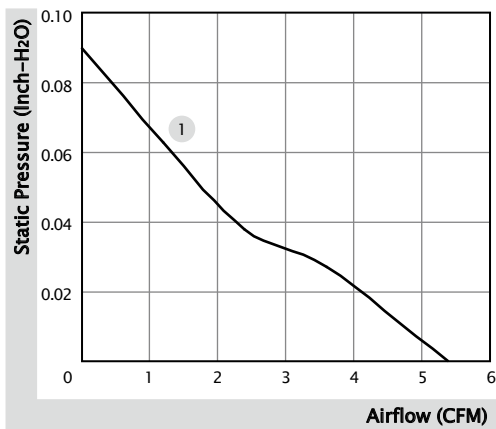

■ External Dimensions(mm)

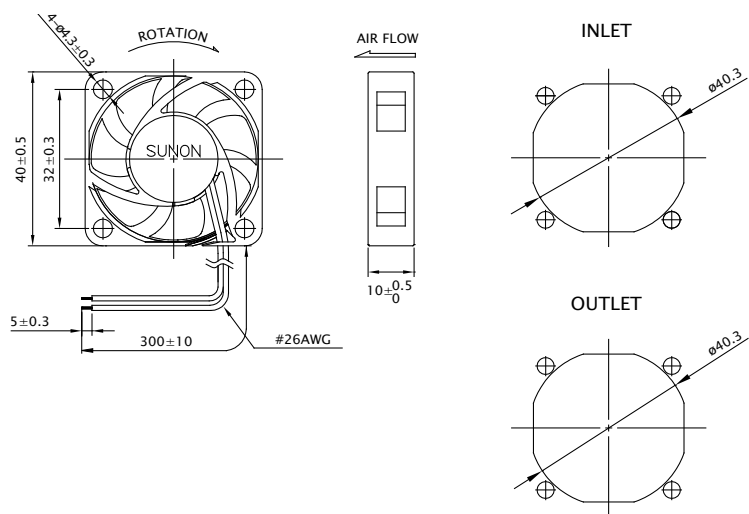

※ All model could be customized. Please contact with Sunon Sales.

※ Specifications are subject to change without notice. Please Visit SUNON website at www.sunon.com for update information.

■ RD / FG Output Signal

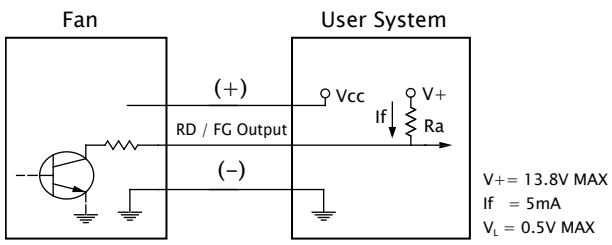

[FG Signal]

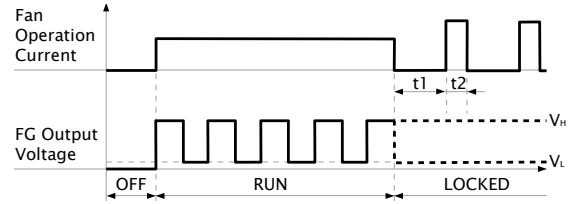
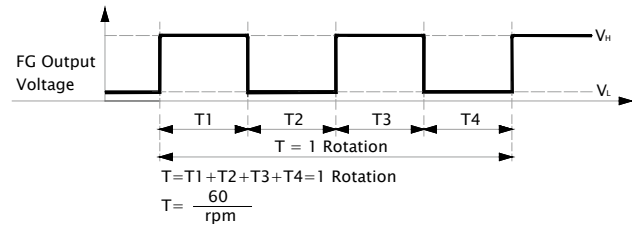

40x40x20 mm

6.3~10.8 CFM



■ Specification

	Bearing	Rated Voltage	Power Current	Power Consumption	Speed	Airflow	Static Pressure	Noise	Weight	Curve
	● VAPO	(VDC)	(mA)	(WATTS)	(RPM)	(CFM)	(inch-H ₂ O)	(dB(A))	(g)	
MF40200V1-10000-A99	●	5	150	0.75	7000	8.9	0.22	25.5	29.0	2
MF40200V2-10000-A99	●	5	107	0.54	6000	7.7	0.17	21.0	29.0	3
MF40200V3-10000-A99	●	5	75	0.38	5000	6.3	0.11	16.5	29.0	4
MF40201VX-10000-A99	●	12	80	0.96	8000	10.8	0.29	27.5	29.0	1
MF40201V1-10000-A99	●	12	58	0.70	7000	8.9	0.22	25.5	29.0	2
MF40201V2-10000-A99	●	12	45	0.54	6000	7.7	0.17	21.0	29.0	3
MF40201V3-10000-A99	●	12	38	0.46	5000	6.3	0.11	16.5	29.0	4
MF40202VX-10000-A99	●	24	39	0.94	8000	10.8	0.29	27.5	29.0	1
MF40202V1-10000-A99	●	24	32	0.77	7000	8.9	0.22	25.5	29.0	2
MF40202V2-10000-A99	●	24	25	0.60	6000	7.7	0.17	21.0	29.0	3
Model	○ 2BALL Sleeve	(VDC)	(mA)	(WATTS)	(RPM)	(CFM)	(inch-H ₂ O)	(dB(A))	(g)	
EE40201SX-10000-999	○	12	105	1.26	8000	10.8	0.29	27.5	29.0	1
EE40201S1-10000-999	○	12	80	0.96	7000	8.9	0.22	25.5	29.0	2
EE40201S2-10000-999	○	12	63	0.76	6000	7.7	0.17	21.0	29.0	3
EE40201S3-10000-999	○	12	52	0.63	5000	6.3	0.11	16.5	29.0	4

■ Function (MF Series) R Type : F99 / F Type : G99
(EE Series) F Type : C99

■ Air Flow-Static Pressure Characteristics

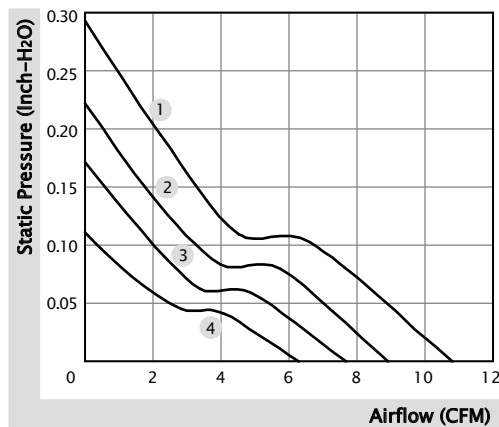

■ External Dimensions(mm)

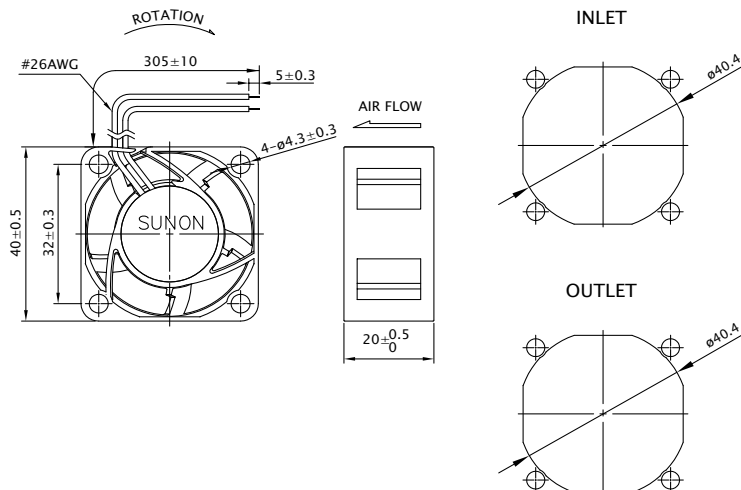

* All model could be customized. Please contact with Sunon Sales.

* Specifications are subject to change without notice. Please Visit SUNON website at www.sunon.com for update information.

■ RD / FG Output Signal

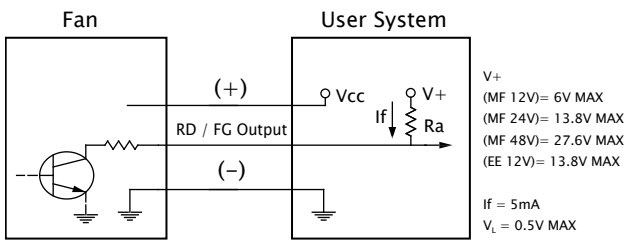

[RD Signal]

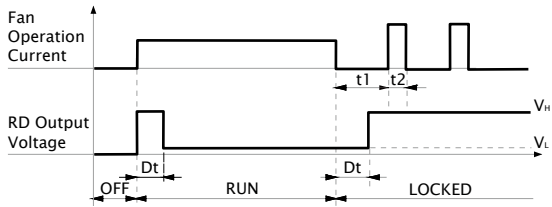

[FG Signal]

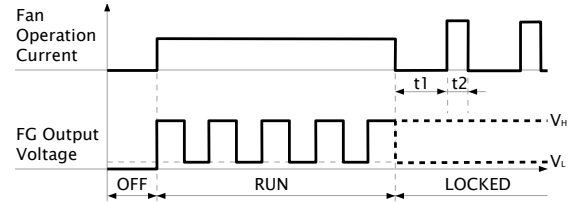
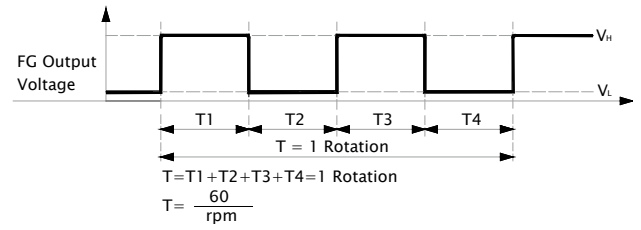

40x40x20 mm

6.3~10.8 CFM

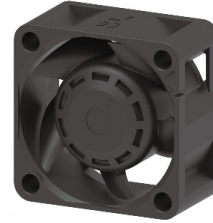

■ Specification

Model	Bearing	Rated Voltage	Power Current	Power Consumption	Speed	Airflow	Static Pressure	Noise	Weight	Curve
	2BALL Sleeve	(VDC)	(mA)	(WATTS)	(RPM)	(CFM)	(inch-H ₂ O)	(dB(A))	(g)	
EF40201BX-10000-A99	☉	12	65	0.78	8200	10.8	0.32	28.5	32.5	1
EF40201B1-10000-A99	☉	12	55	0.66	7200	8.9	0.24	24.5	32.5	2
EF40201B2-10000-A99	☉	12	40	0.48	6200	7.7	0.18	21.3	32.5	3
EF40201B3-10000-A99	☉	12	35	0.42	5200	6.3	0.14	16.2	32.5	4

■ Function R Type : F99 / F Type : G99 / PWM : H99, Q99, S99

■ Air Flow-Static Pressure Characteristics

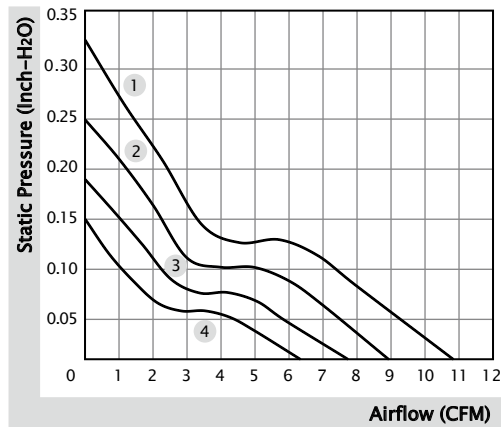

■ External Dimensions(mm)

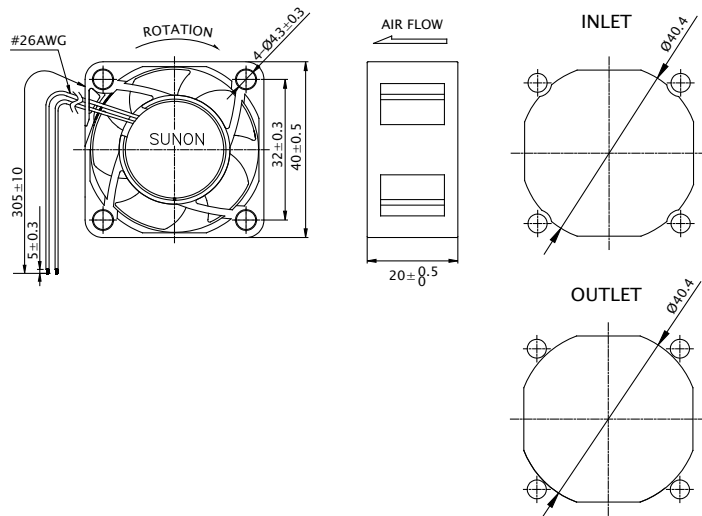

※ All model could be customized. Please contact with Sunon Sales.

※ Specifications are subject to change without notice. Please Visit SUNON website at www.sunon.com for update information.

■ RD / FG Output Signal

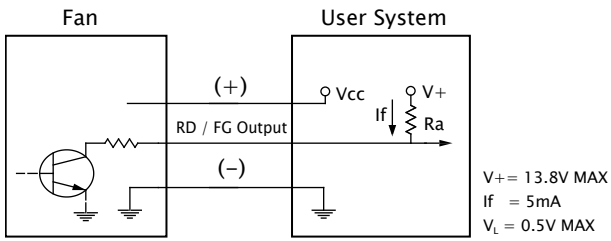

[RD Signal]

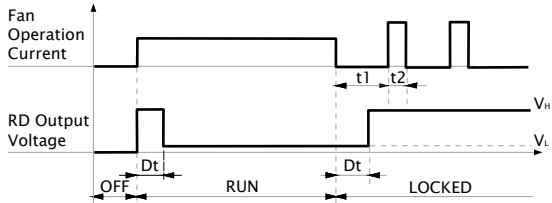

[FG Signal]

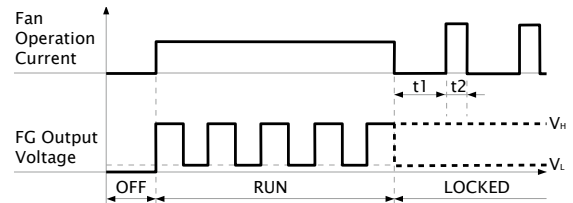
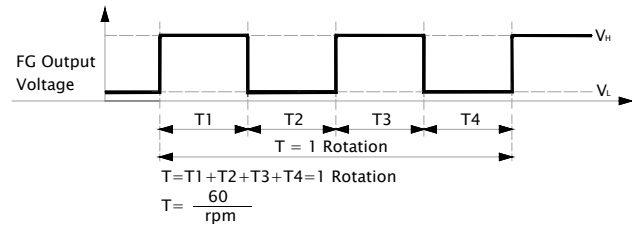

■ PWM Input Signal

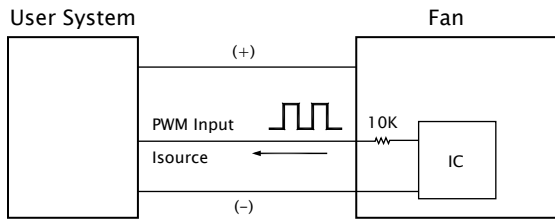

PWM FREQUENCY: 25KHZ
 Isource=0.6mA at PWM Input Voltage 0V
 The Speed is default to be maximum if PWM input pin is unconnected.
 Min. start up duty cycle is 20%.

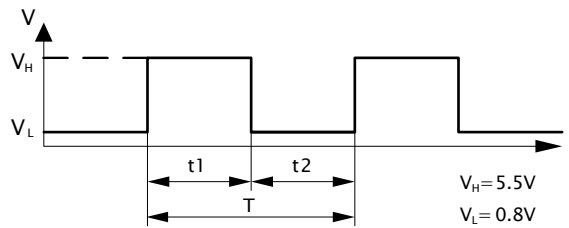

1. Period : $T = \frac{1}{f_{PWM}} = t1 + t2(\text{sec})$
2. Duty Cycle (D.C.) : $\frac{t1}{t1+t2} \times 100 = \frac{t1}{T} \times 100(\%)$

■ PWM Curve

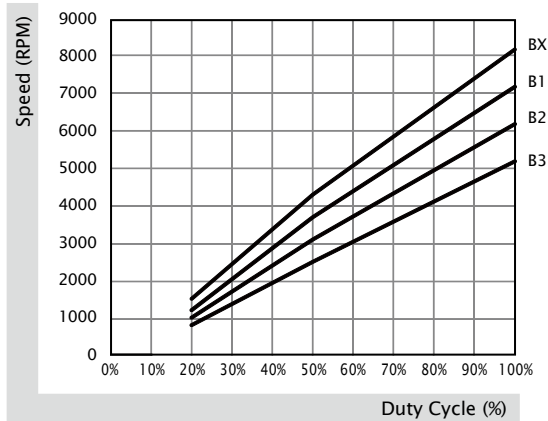

40x40x20 mm

5.5 CFM



■ Specification

	Bearing	Rated Voltage	Power Current	Power Consumption	Speed	Airflow	Static Pressure	Noise	Weight	Curve
	● VAPO	(VDC)	(mA)	(WATTS)	(RPM)	(CFM)	(inch-H ₂ O)	(dB(A))	(g)	
HA40201V4-10000-A99	●	12	31	0.38	4500	5.5	0.10	12.3	30.6	1

■ Function F Type : G99

■ Air Flow-Static Pressure Characteristics

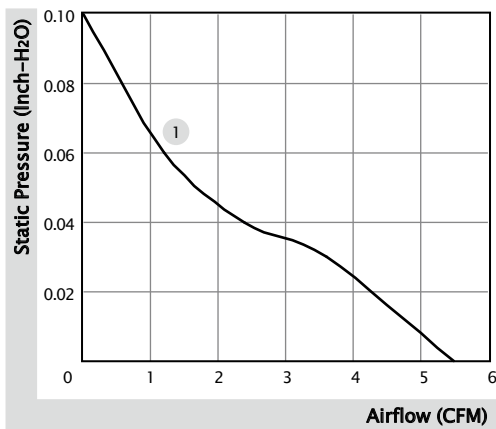

■ External Dimensions(mm)

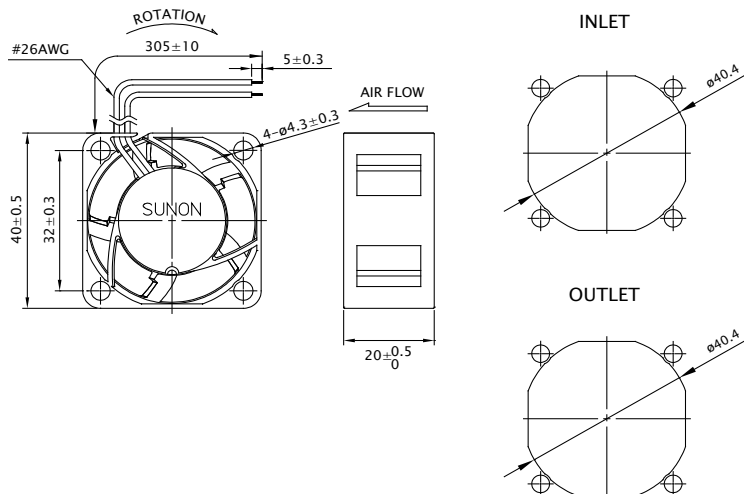

※ All model could be customized. Please contact with Sunon Sales.

※ Specifications are subject to change without notice. Please Visit SUNON website at www.sunon.com for update information.

■ RD / FG Output Signal

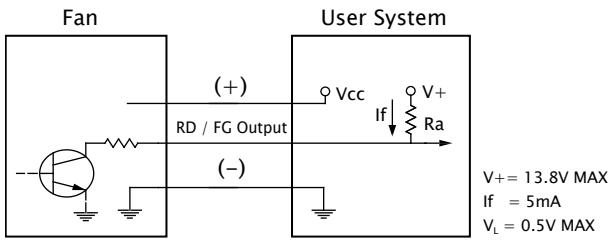

[FG Signal]

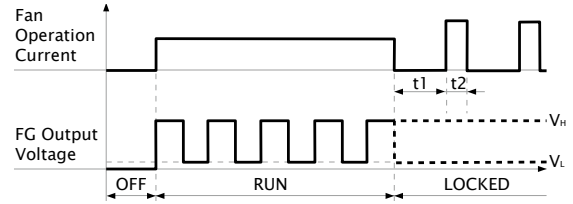
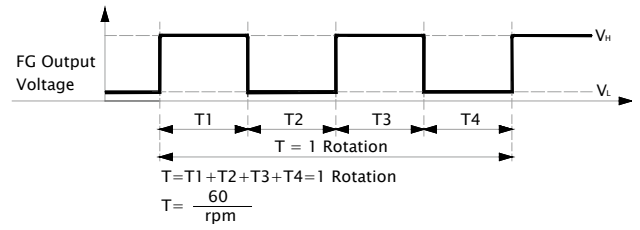

40x40x28 mm

25.6~31.5 CFM

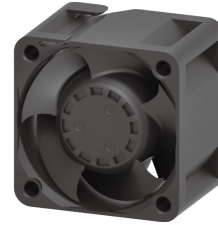

■ Specification

Model	Bearing	Rated Voltage	Power Current	Power Consumption	Speed	Airflow	Static Pressure	Noise	Weight	Curve
	2BALL Sleeve	(VDC)	(mA)	(WATTS)	(RPM)	(CFM)	(inch-H ₂ O)	(dB(A))	(g)	
VF40281BX-0000-A9H	☉	12	1140	13.68	27000	31.5	3.95	63.7	46.0	1
VF40281B1-0000-A9H	☉	12	630	7.56	21600	25.6	2.77	58.6	46.0	2

■ Function F Type : G9H / PWM : S9H

■ Air Flow-Static Pressure Characteristics

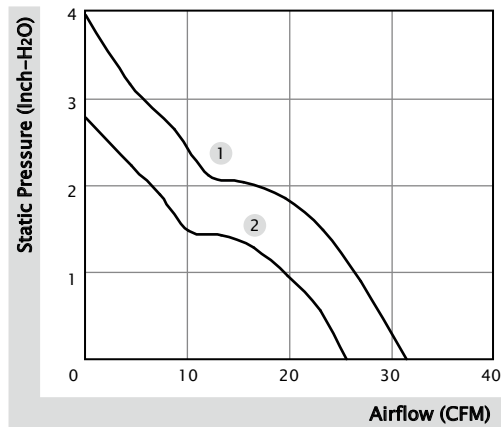

■ External Dimensions(mm)

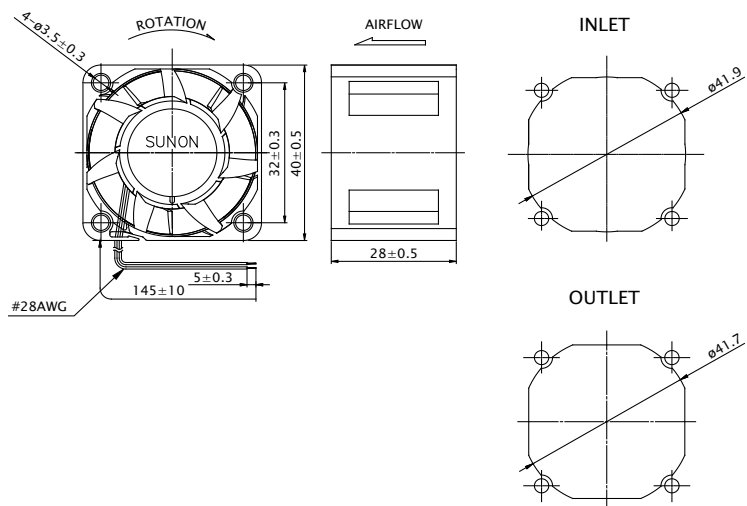

* All model could be customized. Please contact with Sunon Sales.

* Specifications are subject to change without notice. Please Visit SUNON website at www.sunon.com for update information.

■ FG Output Signal

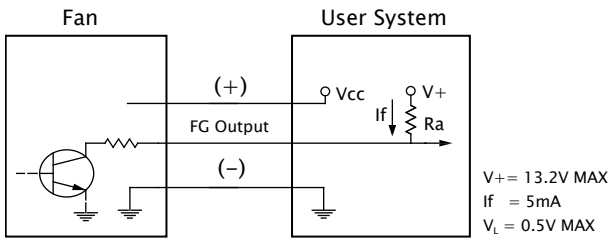

[FG Signal]

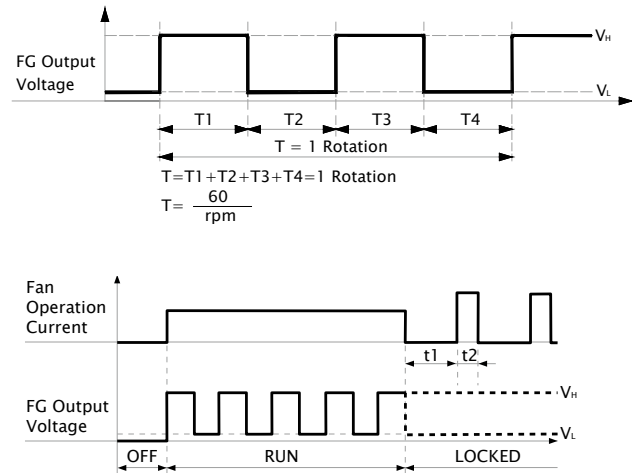

■ PWM Input Signal

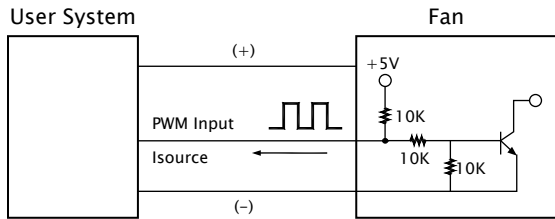

PWM FREQUENCY: 25KHZ
 $I_{source} = 0.5mA$ at PWM Input Voltage 0V
 The speed is default to be maximum if PWM input pin is unconnected.
 Min. start up duty cycle is 10%.

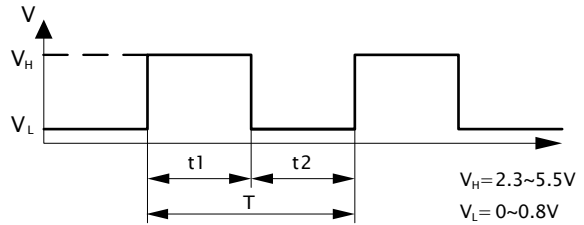

1. Period : $T = \frac{1}{f_{PWM}} = t1 + t2(\text{sec})$
2. Duty Cycle (D.C.) : $\frac{t1}{t1+t2} \times 100 = \frac{t1}{T} \times 100(\%)$

■ PWM Curve

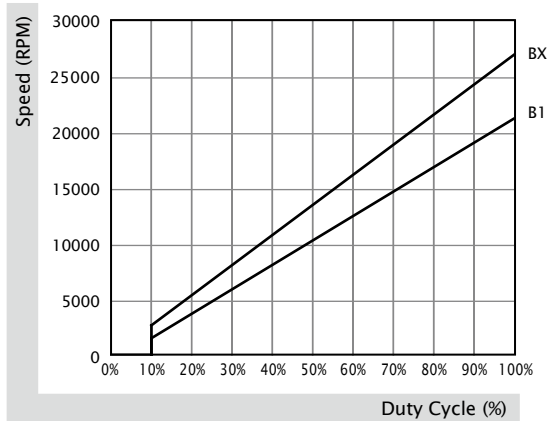

40x40x28 mm

24.9 CFM

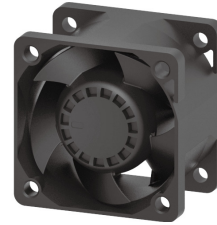

■ Specification

	Bearing	Rated Voltage	Power Current	Power Consumption	Speed	Airflow	Static Pressure	Noise	Weight	Curve
	● VAPO	(VDC)	(mA)	(WATTS)	(RPM)	(CFM)	(inch-H ₂ O)	(dB(A))	(g)	
PF40281V1-0000-A99	●	12	740	8.88	17600	24.9	1.95	56.0	45.0	1

■ Function F Type : G99 / PWM : S99

■ Air Flow-Static Pressure Characteristics

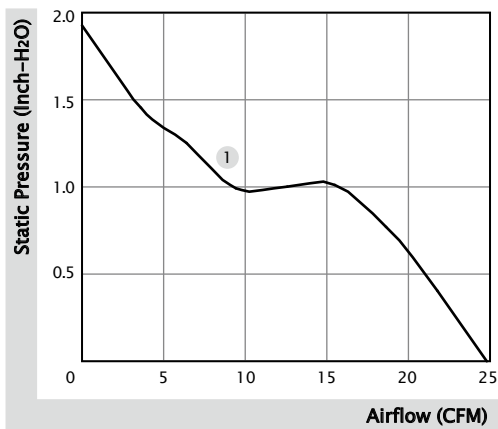

■ External Dimensions(mm)

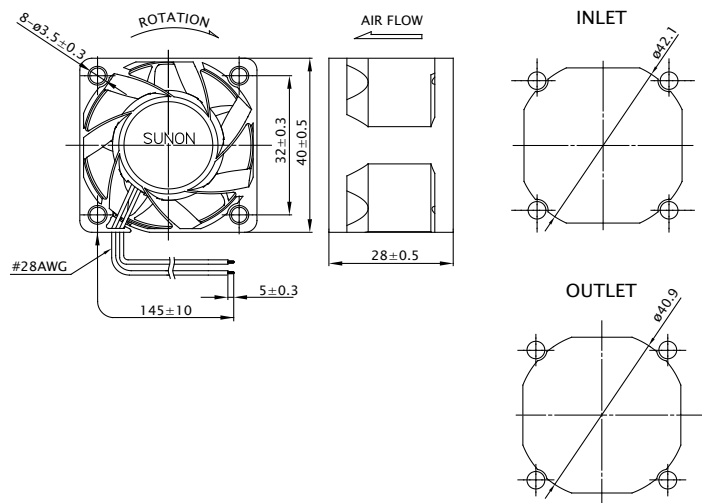

※ All model could be customized. Please contact with Sunon Sales.

※ Specifications are subject to change without notice. Please Visit SUNON website at www.sunon.com for update information.

■ FG Output Signal

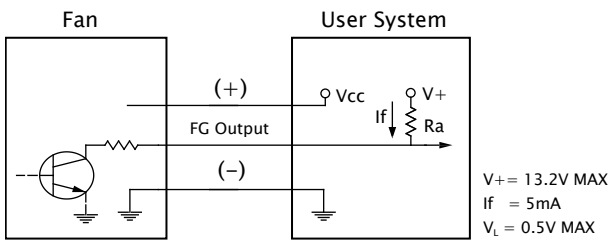

[FG Signal]

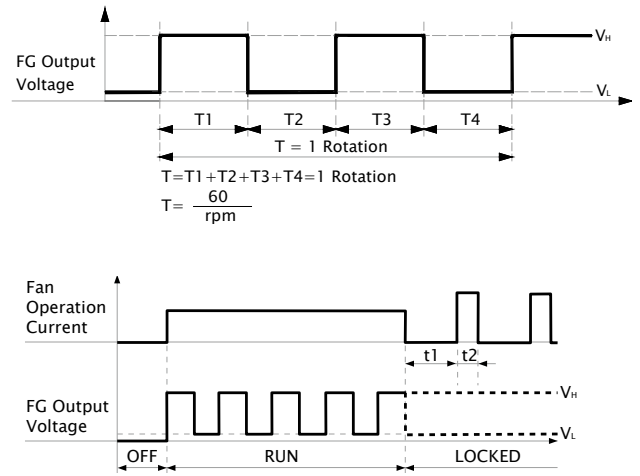

■ PWM Input Signal

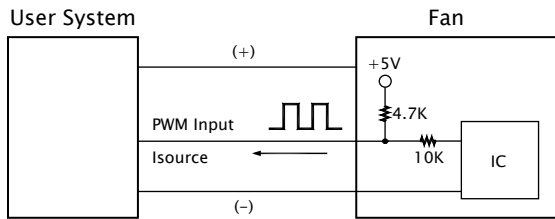

PWM FREQUENCY: 25KHZ
 $I_{source} = 0.5mA$ at PWM Input Voltage 0V
 The speed is default to be maximum if PWM input pin is unconnected.
 Min. start up duty cycle is 10%.

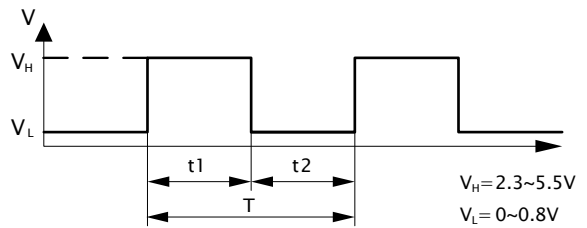

1. Period : $T = \frac{1}{f_{PWM}} = t1 + t2(\text{sec})$
2. Duty Cycle (D.C.) : $\frac{t1}{t1+t2} \times 100 = \frac{t1}{T} \times 100(\%)$

■ PWM Curve

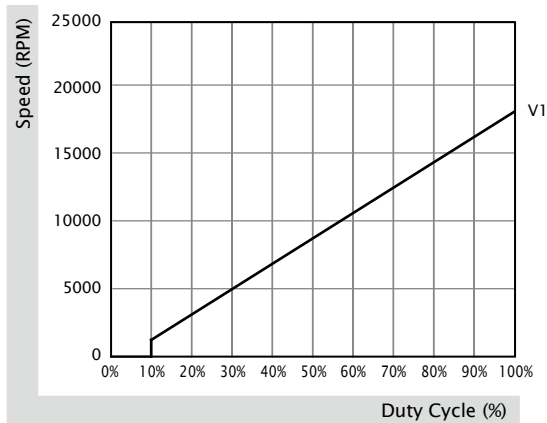

40x40x28 mm

12.8~31.3 CFM

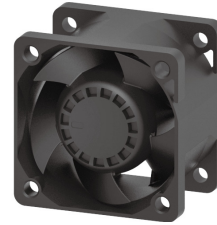

■ Specification

Model	Bearing	Rated Voltage	Power Current	Power Consumption	Speed	Airflow	Static Pressure	Noise	Weight	Curve
	2BALL Sleeve	(VDC)	(mA)	(WATTS)	(RPM)	(CFM)	(inch-H ₂ O)	(dB(A))	(g)	
PF40281BX-10000-A9H	☉	12	950	11.4	22000	31.3	3.12	62.0	42.0	1
PF40281B1-10000-A9H	☉	12	510	6.12	17600	24.9	2.05	56.0	42.0	2
PF40281B2-10000-A9H	☉	12	220	2.64	13000	18.0	1.16	48.7	42.0	3
PF40281B3-10000-A9H	☉	12	145	1.74	11000	15.4	0.78	43.9	42.0	4
PF40281B4-10000-A9H	☉	12	96	1.16	9200	12.8	0.60	39.9	42.0	5

■ Function R Type : F9H / F Type : G9H / PWM : H9H, Q9H, S9H

■ Air Flow-Static Pressure Characteristics

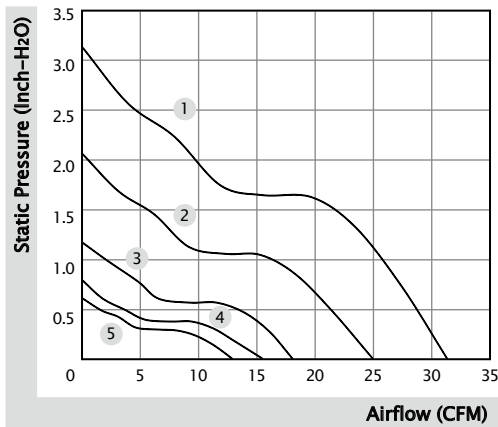

■ External Dimensions(mm)

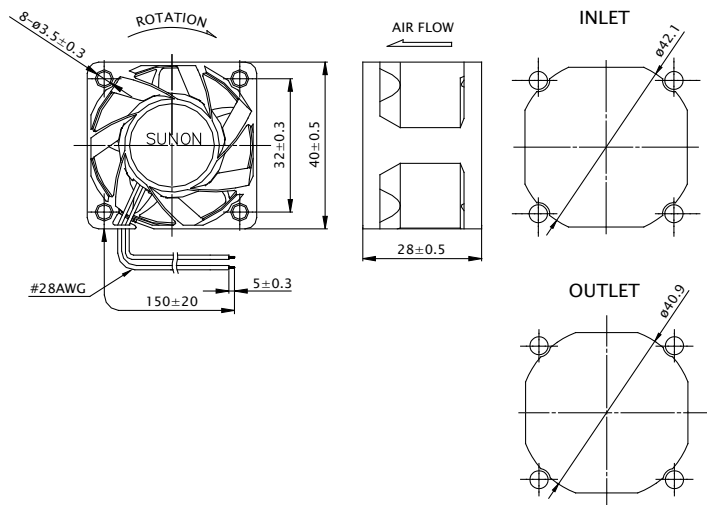

※ All model could be customized. Please contact with Sunon Sales.

※ Specifications are subject to change without notice. Please Visit SUNON website at www.sunon.com for update information.

■ RD / FG Output Signal

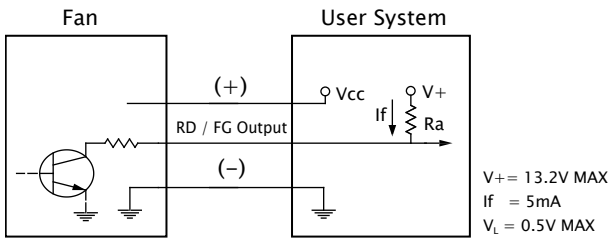

[RD Signal]

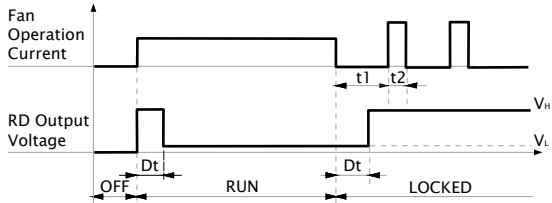

[FG Signal]

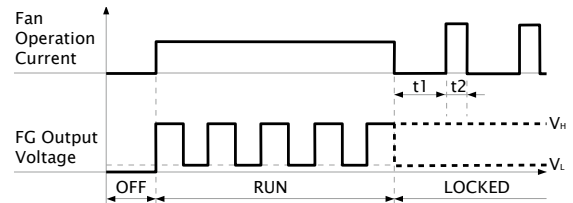
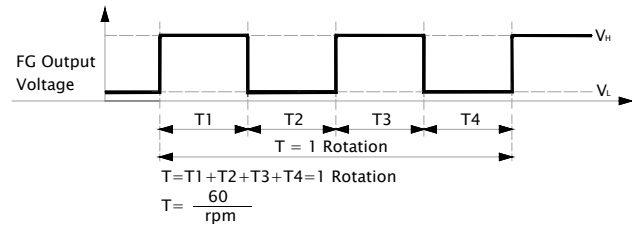

■ PWM Input Signal

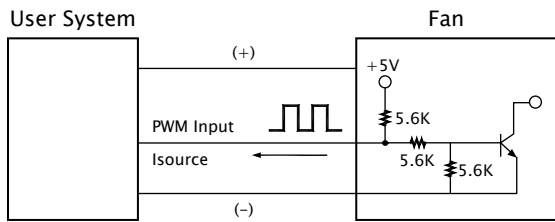

PWM FREQUENCY: 25KHZ
 Isource=0.5mA at PWM Input Voltage 0V
 The speed is default to be maximum if PWM input pin is unconnected.
 Min. start up duty cycle is 10%.

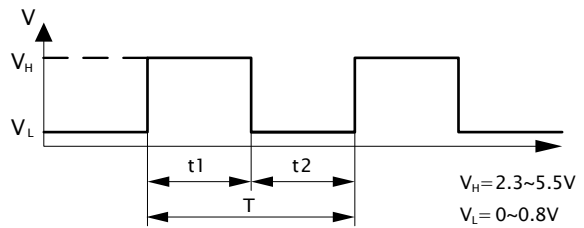

1. Period : $T = \frac{1}{f_{PWM}} = t1 + t2(\text{sec})$

2. Duty Cycle (D.C.) : $\frac{t1}{t1+t2} \times 100 = \frac{t1}{T} \times 100(\%)$

■ PWM Curve

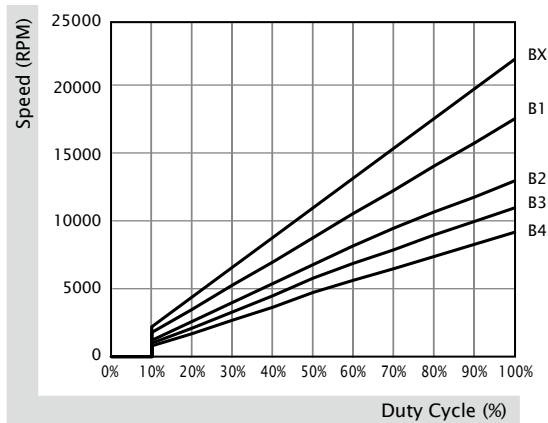

40x40x56 mm

26.9~31.7 CFM

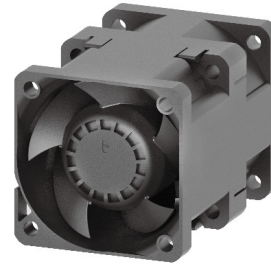

■ Specification

Model	Bearing	Rated Voltage	Power Current	Power Consumption	Speed	Airflow	Static Pressure	Noise	Weight	Curve
	2BALL Sleeve	(VDC)	(mA)	(WATTS)	(RPM)	(CFM)	(inch-H ₂ O)	(dB(A))	(g)	
PF40561BX-10000-A9H	☉	12	1390	16.68	21500/18000	31.7	3.76	65.9	87.0	1
PF40561B1-10000-A9H	☉	12	890	10.68	18000/15000	26.9	2.64	62.3	87.0	2

■ Function R Type : F9H / F Type : G9H / PWM : H9H, Q9H, S9H

■ External dimensions(mm)

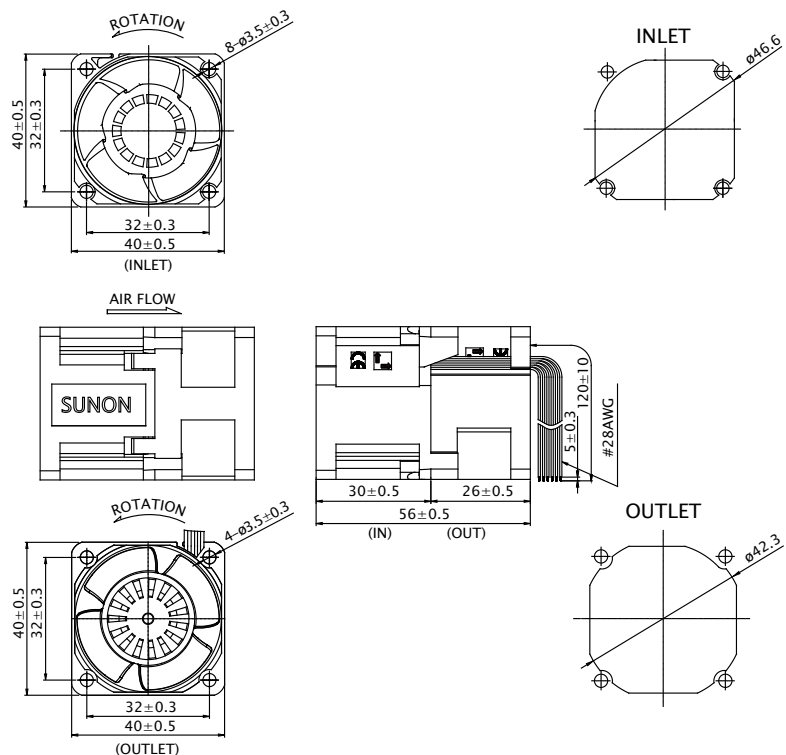

■ Air Flow-Static Pressure Characteristics

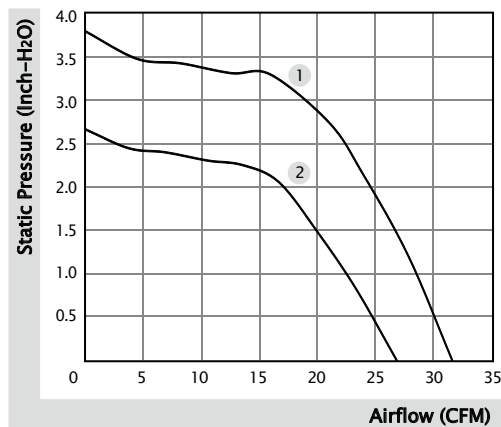

※ All model could be customized. Please contact with Sunon Sales.

※ Specifications are subject to change without notice. Please Visit SUNON website at www.sunon.com for update information.

■ RD / FG Output Signal

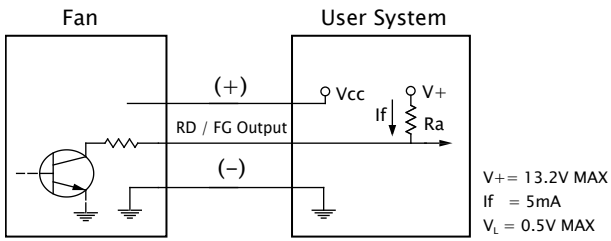

[RD Signal]

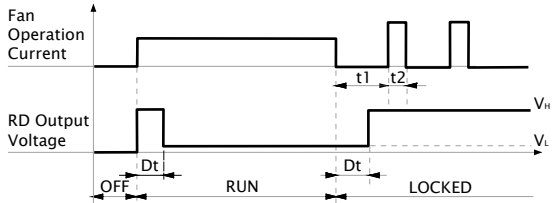

[FG Signal]

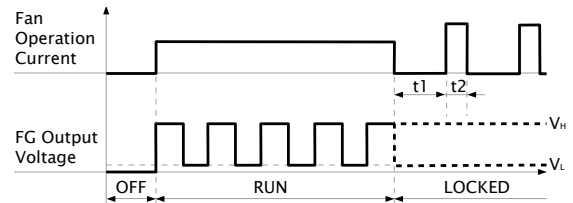
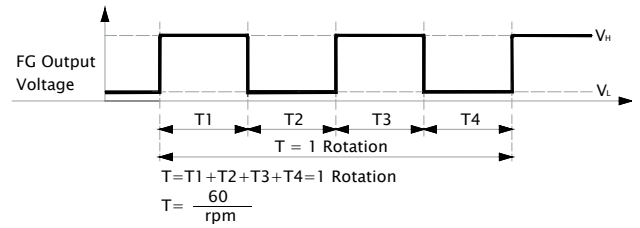

■ PWM Input Signal

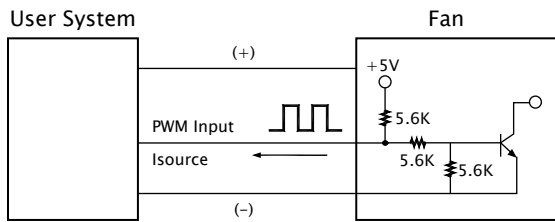

PWM FREQUENCY: 25KHZ
 Isource=0.5mA at PWM Input Voltage 0V
 The speed is default to be maximum if PWM input pin is unconnected.
 Min. start up duty cycle is 10%.

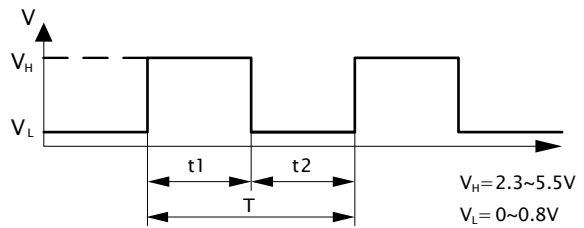

1. Period : $T = \frac{1}{f_{PWM}} = t1 + t2(\text{sec})$
2. Duty Cycle (D.C.) : $\frac{t1}{t1+t2} \times 100 = \frac{t1}{T} \times 100(\%)$

■ PWM Curve

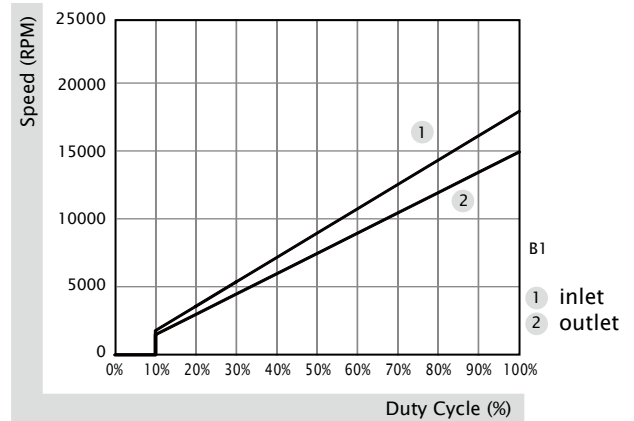
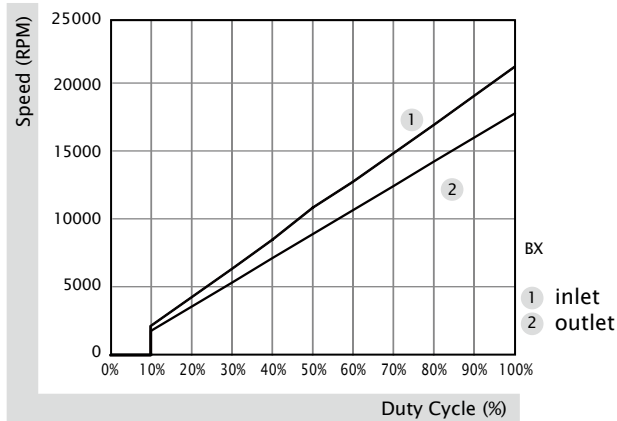

40x40x56 mm

19.7~25.0 CFM

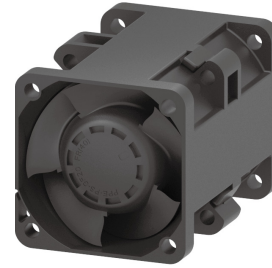

■ Specification

Model	Bearing	Rated Voltage	Power Current	Power Consumption	Speed	Airflow	Static Pressure	Noise	Weight	Curve
	2BALL Sleeve	(VDC)	(mA)	(WATTS)	(RPM)	(CFM)	(inch-H ₂ O)	(dB(A))	(g)	
VG40561BX-0000-A9H	☉	12	1400	16.80	25500/22300	25.0	6.19	65.0	87.0	1
VG40561B1-0000-A9H	☉	12	750	9.00	20400/17800	19.7	4.16	62.5	87.0	2

■ Function F Type : G9H / PWM : S9H

■ Air Flow-Static Pressure Characteristics

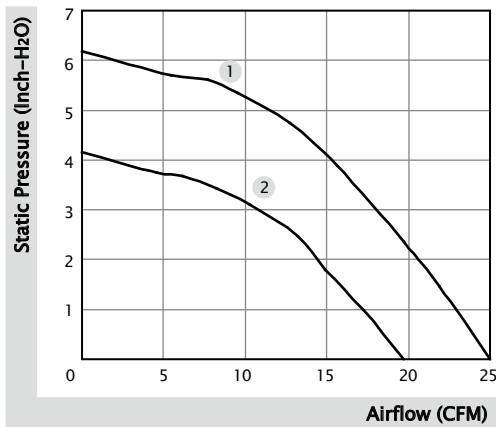

■ External Dimensions(mm)

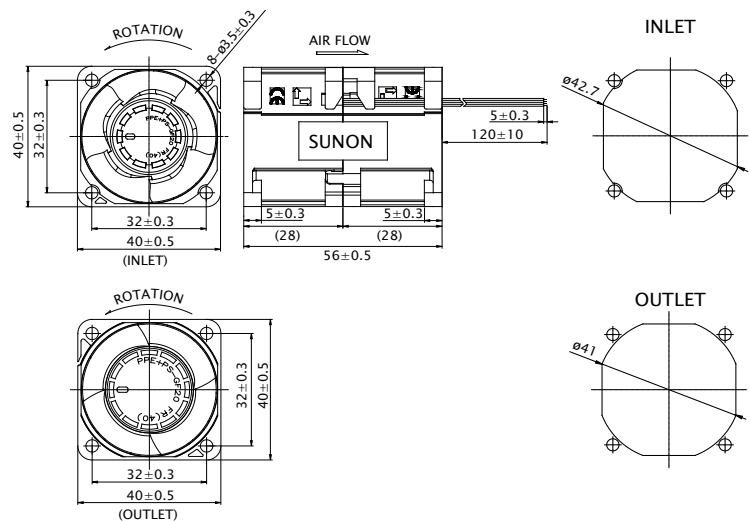

* All model could be customized. Please contact with Sunon Sales.

* Specifications are subject to change without notice. Please Visit SUNON website at www.sunon.com for update information.

■ FG Output Signal

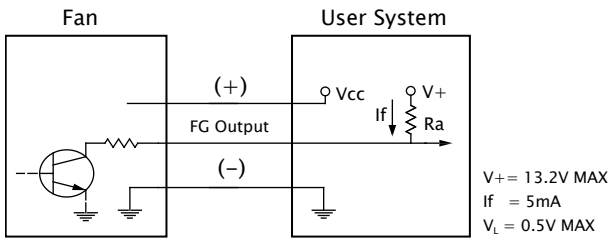

[FG Signal]

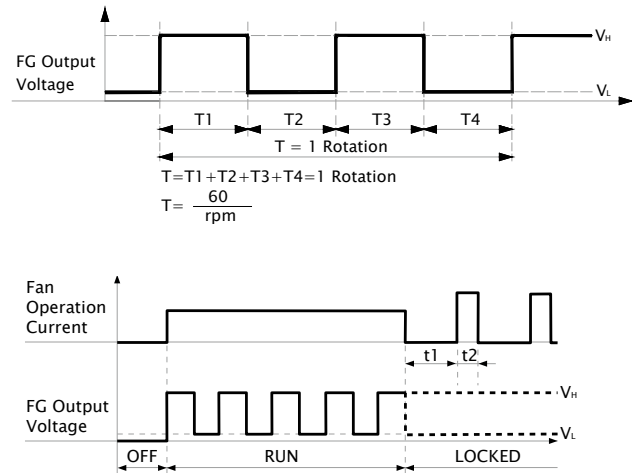

■ PWM Input Signal

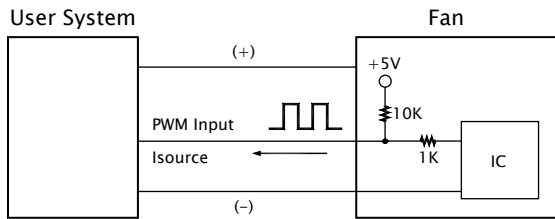

The speed is default to be maximum if PWM input pin is unconnected.
 Min. start up duty cycle is 10%.

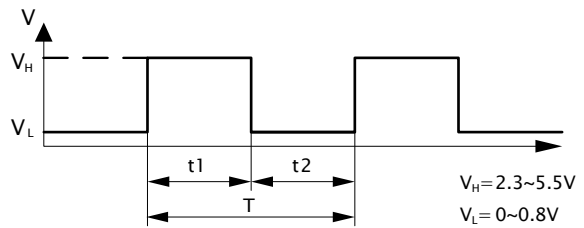

1. Period : $T = \frac{1}{f_{PWM}} = t_1 + t_2 (\text{sec})$

2. Duty Cycle (D.C.) : $\frac{t_1}{t_1 + t_2} \times 100 = \frac{t_1}{T} \times 100(\%)$

■ PWM Curve

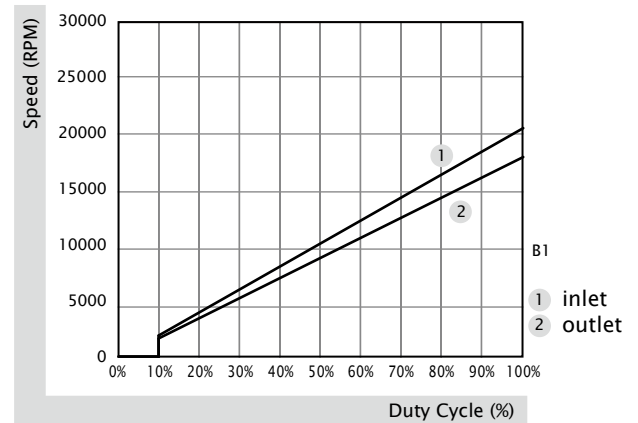
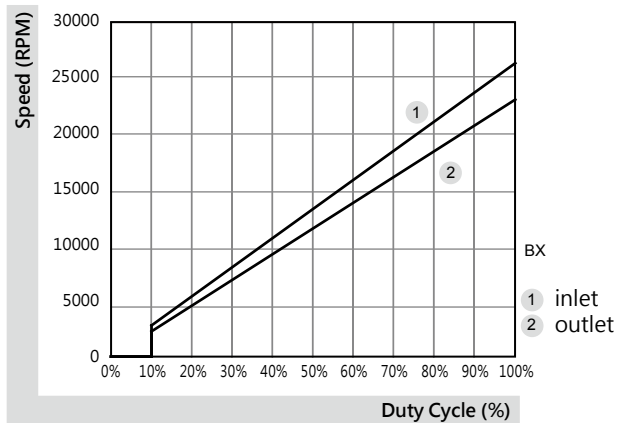

45x45x10 mm

9.2~11.8 CFM



■ Specification

	Bearing	Rated Voltage	Power Current	Power Consumption	Speed	Airflow	Static Pressure	Noise	Weight	Curve
	● VAPO	(VDC)	(mA)	(WATTS)	(RPM)	(CFM)	(inch-H ₂ O)	(dB(A))	(g)	
ME45101V1-0000-A99	●	12	110	1.32	6500	11.8	0.18	32.5	16.0	1
MB45101V2-0000-A99	●	12	105	1.26	5000	9.2	0.12	27.0	18.5	3
Model	○ 2BALL Sleeve	(VDC)	(mA)	(WATTS)	(RPM)	(CFM)	(inch-H ₂ O)	(dB(A))	(g)	
EE45101S1-0000-999	○	12	110	1.32	5700	10.5	0.16	31.0	16.0	2
EB45101S2-0000-999	○	12	120	1.44	5000	9.2	0.12	27.0	18.5	3

- Function (ME Series) R Type : F99 / F Type : G99
 (MB Series) F Type : G99
 (EE, EB Series) F Type : C99

■ Air Flow-Static Pressure Characteristics

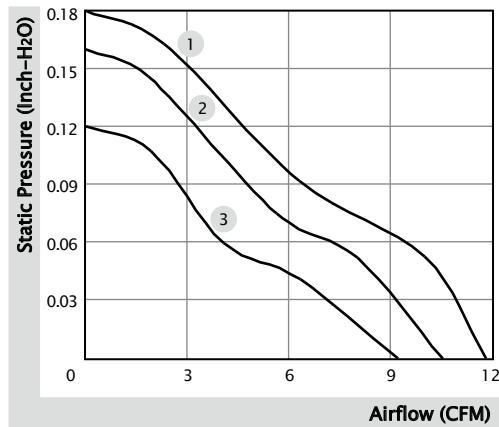

■ External Dimensions(mm)

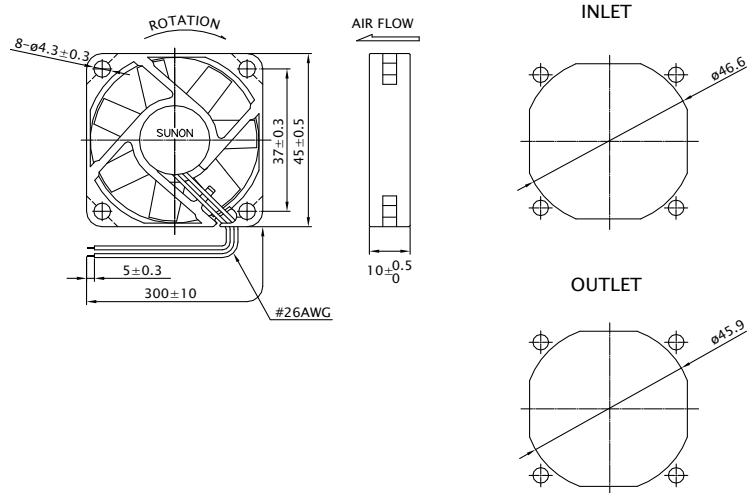

※ All model could be customized. Please contact with Sunon Sales.

※ Specifications are subject to change without notice. Please Visit SUNON website at www.sunon.com for update information.

■ RD / FG Output Signal

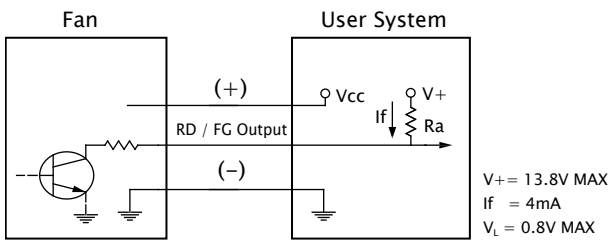

[RD Signal]

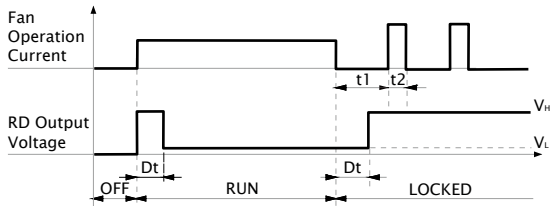

[FG Signal]

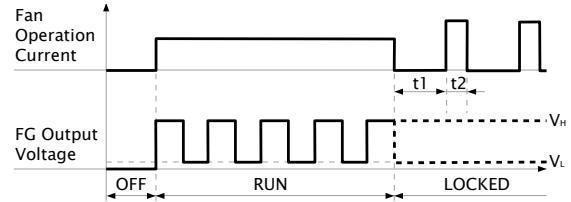
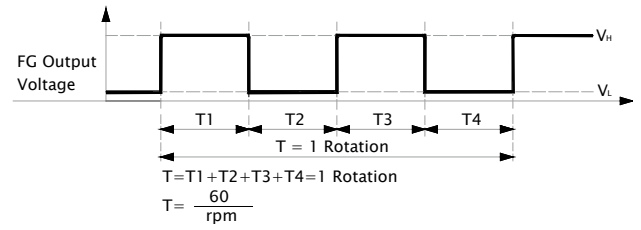

50x50x10 mm

8.4~13.8 CFM



■ Specification

	Bearing	Rated Voltage	Power Current	Power Consumption	Speed	Airflow	Static Pressure	Noise	Weight	Curve
	● VAPO	(VDC)	(mA)	(WATTS)	(RPM)	(CFM)	(inch-H ₂ O)	(dB(A))	(g)	
MF50100V1-10000-A99	●	5	155	0.78	5800	13.8	0.15	30.7	19.5	1
MF50100V2-10000-A99	●	5	85	0.43	4800	11.0	0.11	25.6	19.5	3
MF50100V3-10000-A99	●	5	75	0.38	4300	8.4	0.08	22.4	19.5	4
MF50101V1-10000-A99	●	12	70	0.84	5800	13.8	0.15	30.7	19.5	1
MF50101V2-10000-A99	●	12	50	0.60	4800	11.0	0.11	25.6	19.5	3
MF50101V3-10000-A99	●	12	37	0.45	4300	8.4	0.08	22.4	19.5	4
Model	○ 2BALL Sleeve	(VDC)	(mA)	(WATTS)	(RPM)	(CFM)	(inch-H ₂ O)	(dB(A))	(g)	
EE50101S1-10000-999	○	12	90	1.08	5700	13.0	0.14	30.7	19.5	2
EE50101S2-10000-999	○	12	75	0.90	4700	11.0	0.11	25.6	19.5	3

■ Function (MF Series) R Type : F99 / F Type : G99
(EE, EB Series) F Type : C99

■ Air Flow-Static Pressure Characteristics

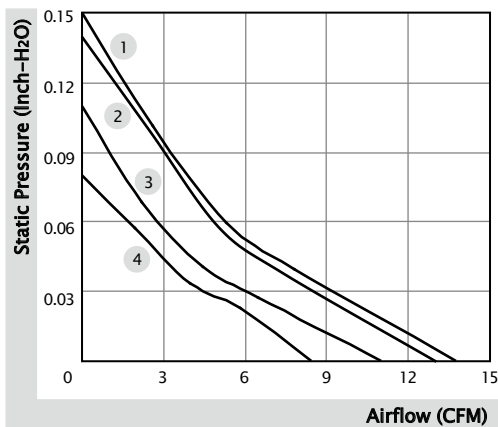

■ External Dimensions(mm)

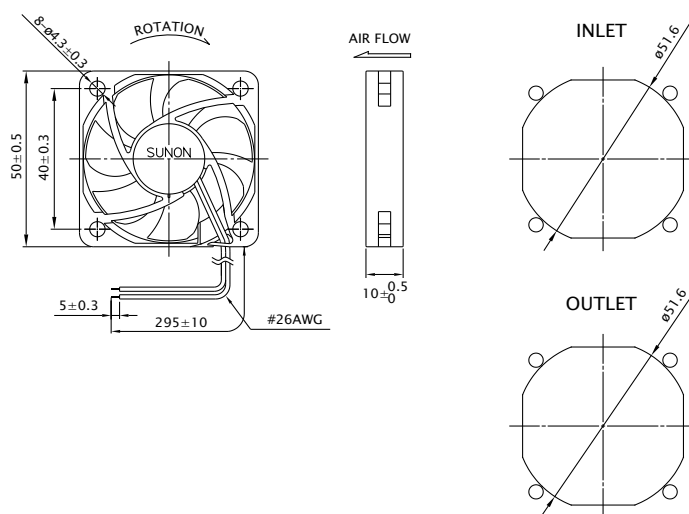

※ All model could be customized. Please contact with Sunon Sales.

※ Specifications are subject to change without notice. Please Visit SUNON website at www.sunon.com for update information.

■ RD / FG Output Signal

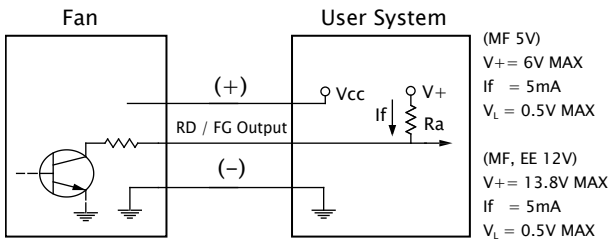

[RD Signal]

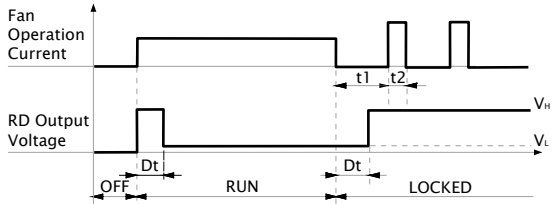

[FG Signal]

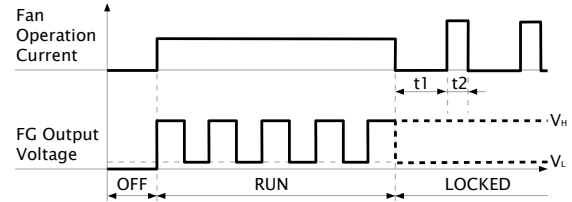
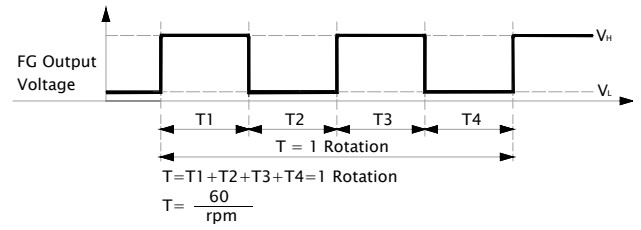

50x50x15 mm

10.2~18.6 CFM



■ Specification

	Bearing	Rated Voltage	Power Current	Power Consumption	Speed	Airflow	Static Pressure	Noise	Weight	Curve
	● VAPO	(VDC)	(mA)	(WATTS)	(RPM)	(CFM)	(inch-H ₂ O)	(dB(A))	(g)	
MF50151VX-10000-A99	●	12	100	1.20	7200	18.6	0.31	38.1	33.0	1
MF50151V1-10000-A99	●	12	66	0.80	6100	17.0	0.23	33.0	33.0	2
MF50151V2-10000-A99	●	12	42	0.51	5000	13.0	0.17	29.0	33.0	3
MF50151V3-10000-A99	●	12	28	0.34	3800	10.2	0.12	20.1	33.0	4
MF50152VX-10000-A99	●	24	55	1.32	7200	18.6	0.31	38.1	33.0	1
MF50152V1-10000-A99	●	24	42	1.01	6100	17.0	0.23	33.0	33.0	2
MF50152V2-10000-A99	●	24	27	0.65	5000	13.0	0.17	29.0	33.0	3

■ Function R Type : F99 / F Type : G99

■ Air Flow-Static Pressure Characteristics

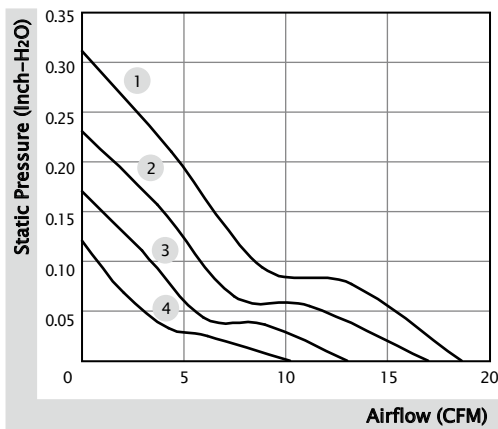

■ External Dimensions(mm)

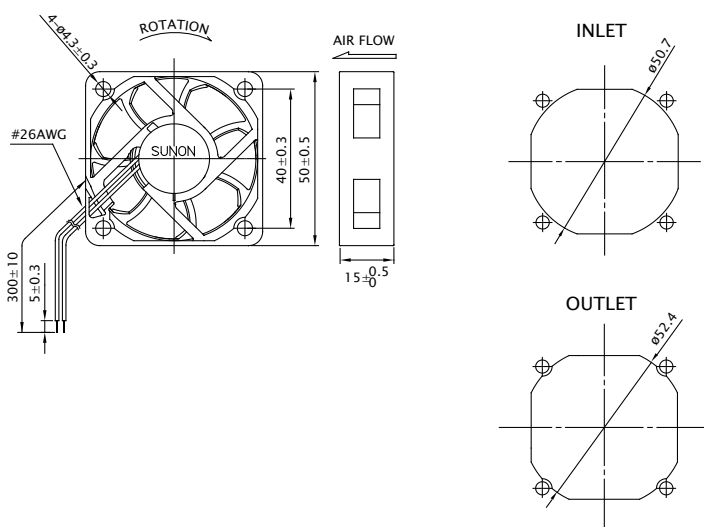

※ All model could be customized. Please contact with Sunon Sales.

※ Specifications are subject to change without notice. Please Visit SUNON website at www.sunon.com for update information.

■ RD / FG Output Signal

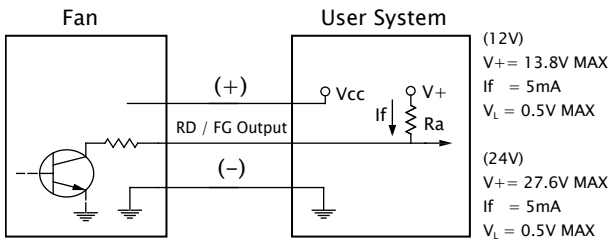

[RD Signal]

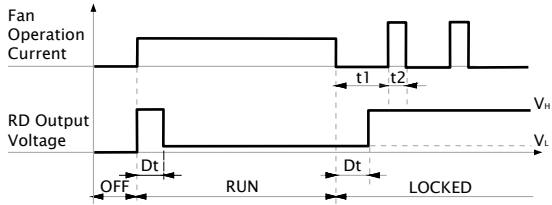

[FG Signal]

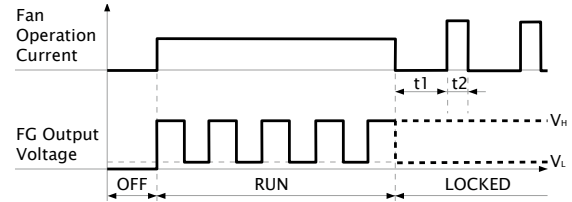
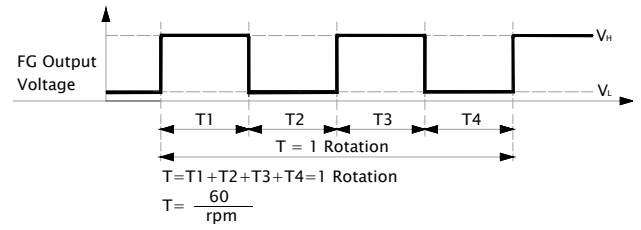

50x50x15 mm

7.7 CFM



■ Specification

	Bearing	Rated Voltage	Power Current	Power Consumption	Speed	Airflow	Static Pressure	Noise	Weight	Curve
	● VAPO	(VDC)	(mA)	(WATTS)	(RPM)	(CFM)	(inch-H ₂ O)	(dB(A))	(g)	
HA50151V4-10000-A99	●	12	25	0.30	3200	7.7	0.07	15.4	33.0	1

■ Function F Type : G99

■ Air Flow-Static Pressure Characteristics

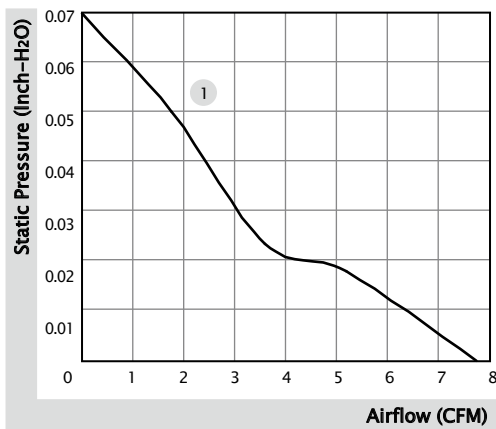

■ External Dimensions(mm)

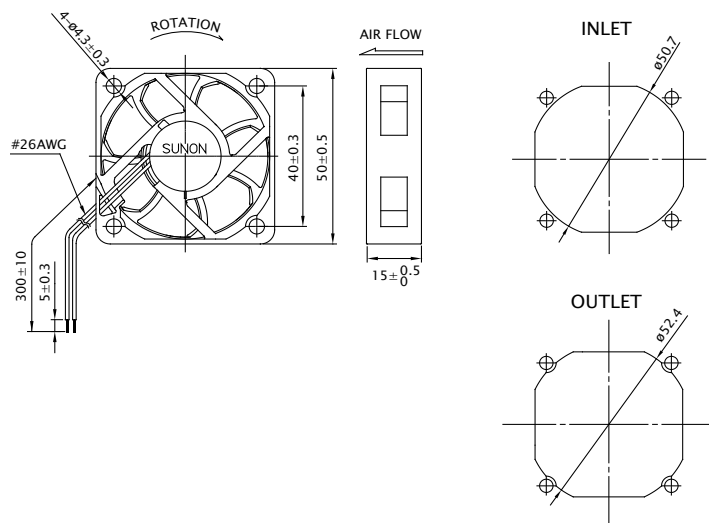

※ All model could be customized. Please contact with Sunon Sales.

※ Specifications are subject to change without notice. Please Visit SUNON website at www.sunon.com for update information.

■ FG Output Signal

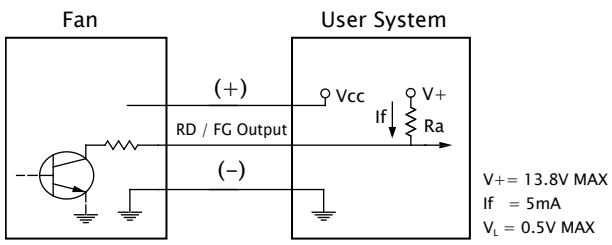

[FG Signal]

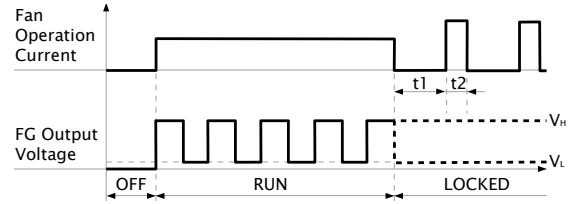
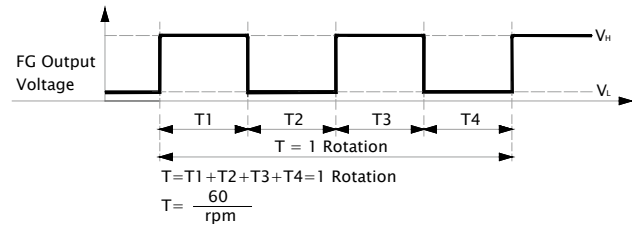

60x60x10 mm

12.2~16.3 CFM



■ Specification

	Bearing	Rated Voltage	Power Current	Power Consumption	Speed	Airflow	Static Pressure	Noise	Weight	Curve
	● VAPO	(VDC)	(mA)	(WATTS)	(RPM)	(CFM)	(inch-H ₂ O)	(dB(A))	(g)	
MF60101V1-10000-A99	●	12	108	1.30	4000	16.3	0.12	28.5	23.0	1
MF60101V2-10000-A99	●	12	75	0.90	3500	14.3	0.10	25.0	23.0	2
MF60101V3-10000-A99	●	12	46	0.56	3000	12.2	0.08	20.5	23.0	3

■ Function R Type : F99 / F Type : G99

■ Air Flow-Static Pressure Characteristics

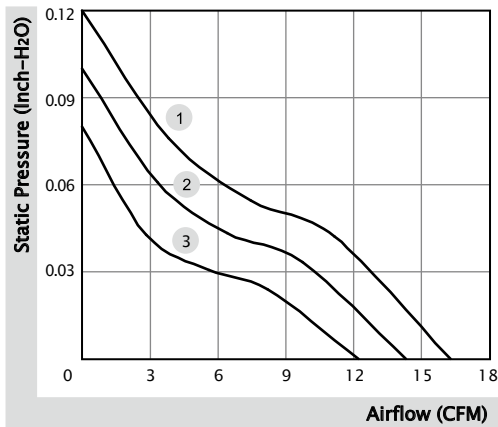

■ External Dimensions(mm)

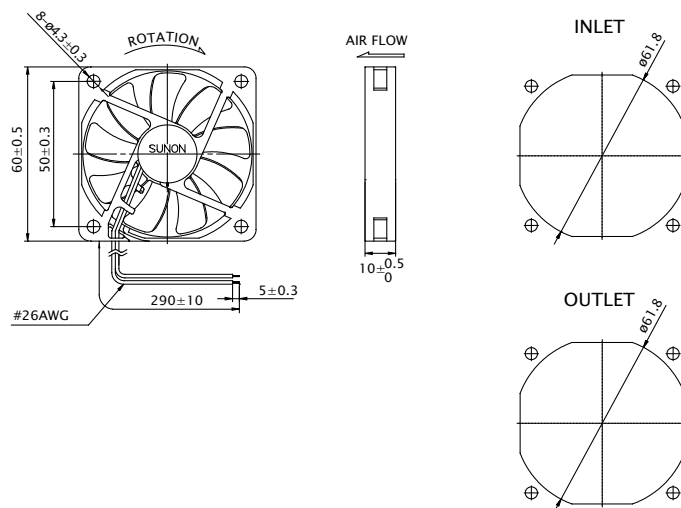

※ All model could be customized. Please contact with Sunon Sales.

※ Specifications are subject to change without notice. Please Visit SUNON website at www.sunon.com for update information.

■ RD / FG Output Signal

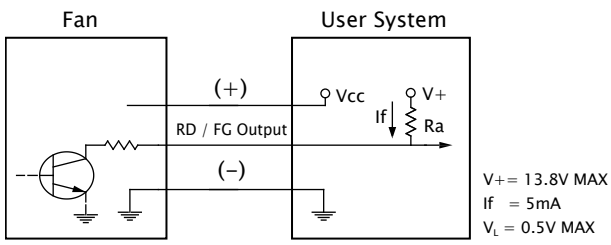

[RD Signal]

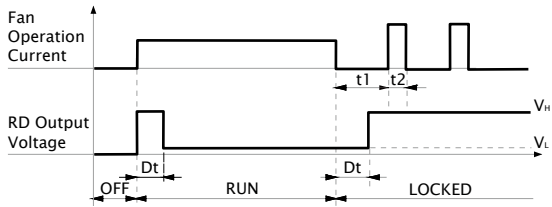

[FG Signal]

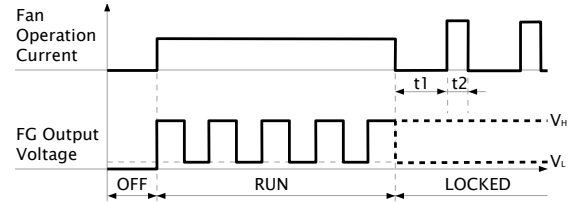
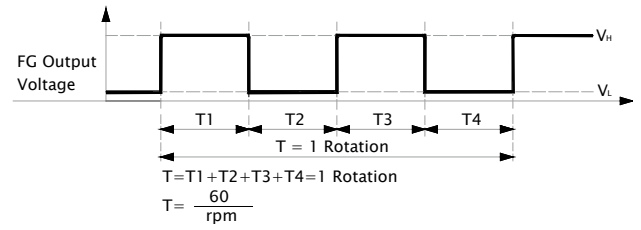

60x60x15 mm

17.6~30.4 CFM



■ Specification

	Bearing	Rated Voltage	Power Current	Power Consumption	Speed	Airflow	Static Pressure	Noise	Weight	Curve
	● VAPO	(VDC)	(mA)	(WATTS)	(RPM)	(CFM)	(inch-H ₂ O)	(dB(A))	(g)	
MF60151VX-10000-A99	●	12	185	2.22	5400	30.4	0.22	36.2	35.5	1
MF60151V1-10000-A99	●	12	127	1.53	4700	26.4	0.18	34.2	35.5	2
MF60151V2-10000-A99	●	12	68	0.82	3900	22.8	0.14	29.2	35.5	3
MF60151V3-10000-A99	●	12	48	0.58	3000	17.6	0.12	21.3	35.5	4
MF60152VX-10000-A99	●	24	85	2.04	5400	30.4	0.22	36.2	35.5	1
MF60152V1-10000-A99	●	24	75	1.80	4700	26.4	0.18	34.2	35.5	2
MF60152V2-10000-A99	●	24	40	0.96	3900	22.8	0.14	29.2	35.5	3

■ Function R Type : F99 / F Type : G99

■ Air Flow-Static Pressure Characteristics

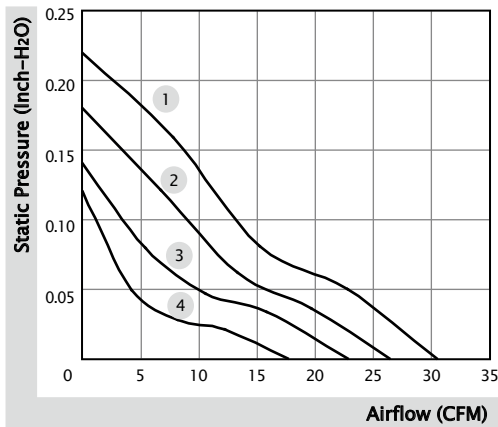

■ External Dimensions(mm)

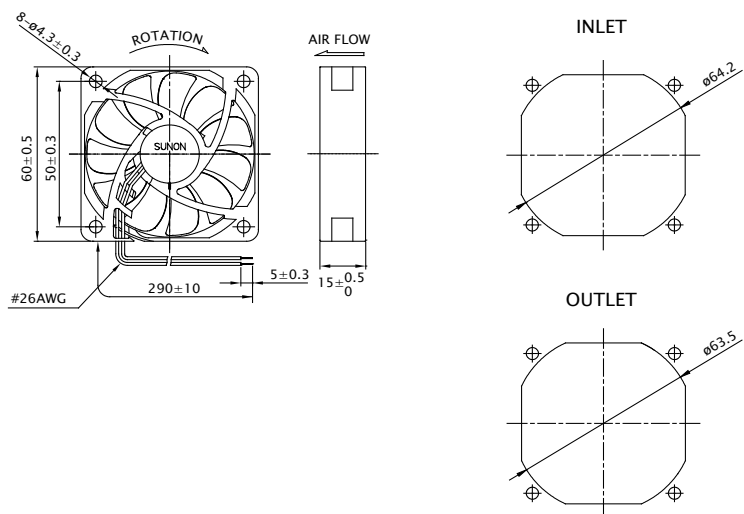

* All model could be customized. Please contact with Sunon Sales.

* Specifications are subject to change without notice. Please Visit SUNON website at www.sunon.com for update information.

■ RD / FG Output Signal

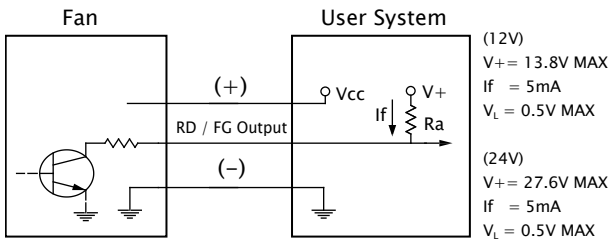

[RD Signal]

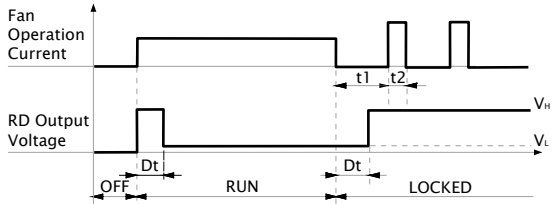

[FG Signal]

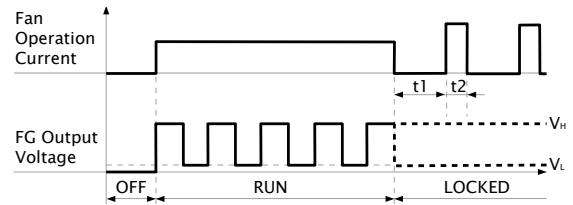
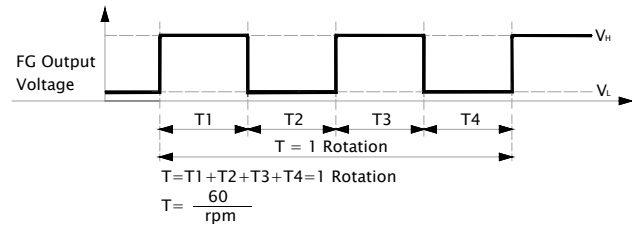

60x60x15 mm

12.7 CFM



■ Specification

	Bearing	Rated Voltage	Power Current	Power Consumption	Speed	Airflow	Static Pressure	Noise	Weight	Curve
	● VAPO	(VDC)	(mA)	(WATTS)	(RPM)	(CFM)	(inch-H ₂ O)	(dB(A))	(g)	
HA60151V4-10000-A99	●	12	22	0.27	2200	12.7	0.04	14.5	35.0	1

■ Function F Type : G99

■ Air Flow-Static Pressure Characteristics

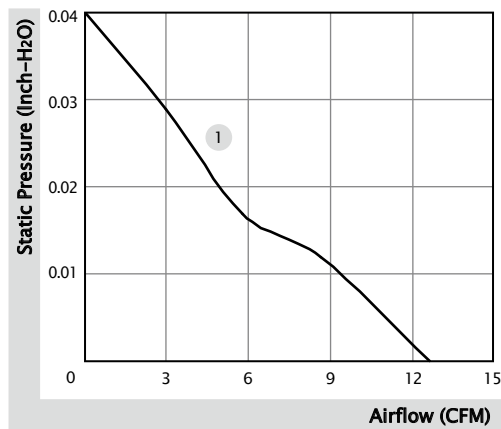

■ External Dimensions(mm)

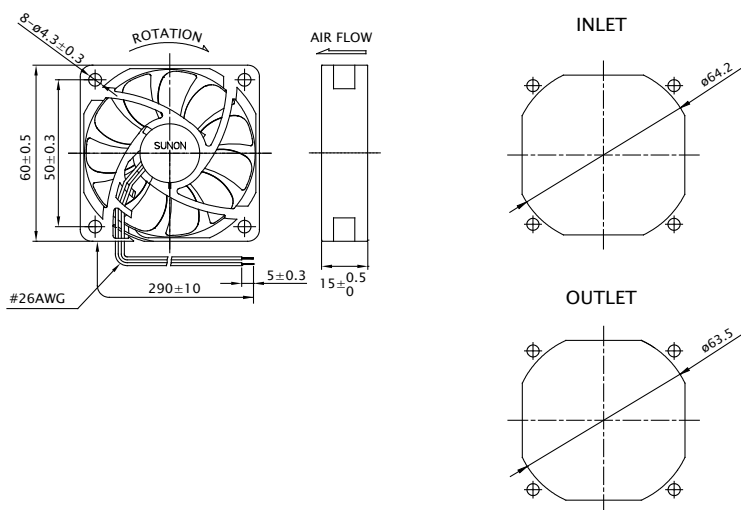

※ All model could be customized. Please contact with Sunon Sales.

※ Specifications are subject to change without notice. Please Visit SUNON website at www.sunon.com for update information.

■ RD / FG Output Signal

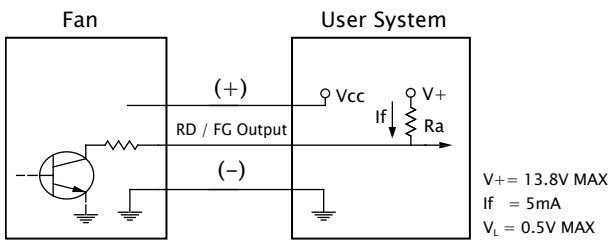

[FG Signal]

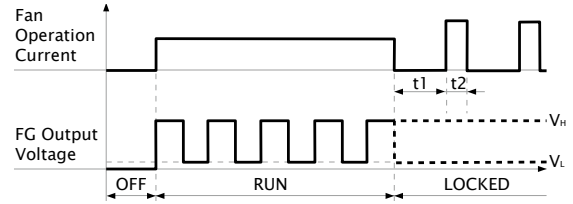
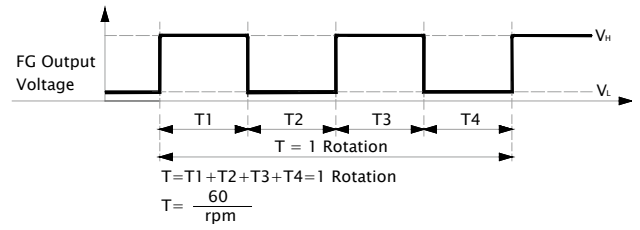

60x60x15 mm (IP68)

10.6~21.3 CFM



■ Specification

Model	Bearing	Rated Voltage	Power Current	Power Consumption	Speed	Airflow	Static Pressure	Noise	Weight	Curve
	2BALL Sleeve	(VDC)	(mA)	(WATTS)	(RPM)	(CFM)	(inch-H ₂ O)	(dB(A))	(g)	
GF60151B6-1E000-AE9	☉	12	125	1.50	4500	21.3	0.18	34.5	47.0	1
GF60151B7-1E000-AE9	☉	12	80	0.96	3900	18.2	0.13	29.8	47.0	2
GF60151B8-1E000-AE9	☉	12	70	0.84	3200	14.5	0.09	24.9	47.0	3
GF60151B9-1E000-AE9	☉	12	32	0.39	2300	10.6	0.05	17.1	47.0	4

■ Function R Type : FE9 / F Type : GE9

■ Air Flow-Static Pressure Characteristics

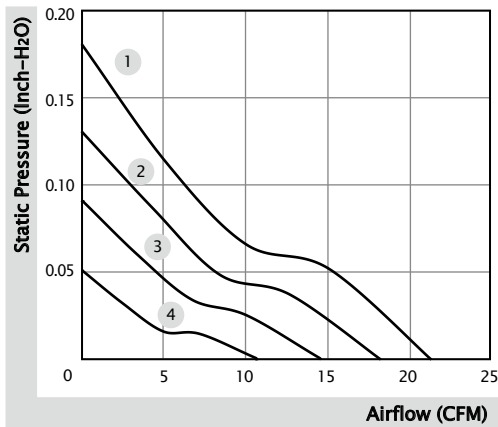

■ External Dimensions(mm)

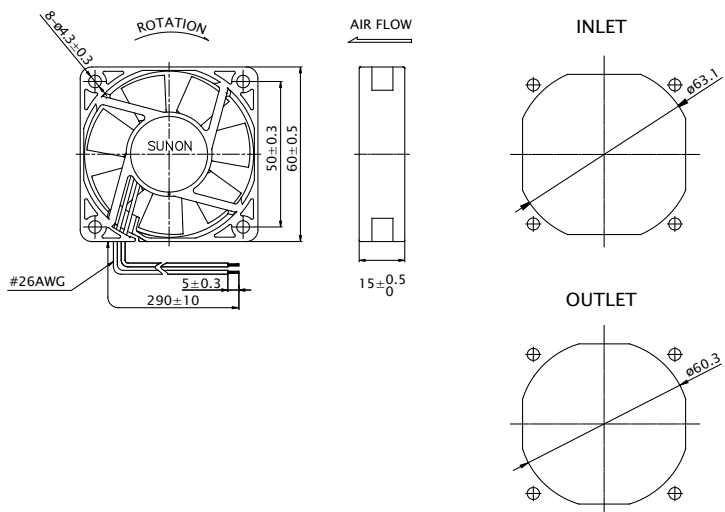

※ All model could be customized. Please contact with Sunon Sales.

※ Specifications are subject to change without notice. Please Visit SUNON website at www.sunon.com for update information.

■ RD / FG Output Signal

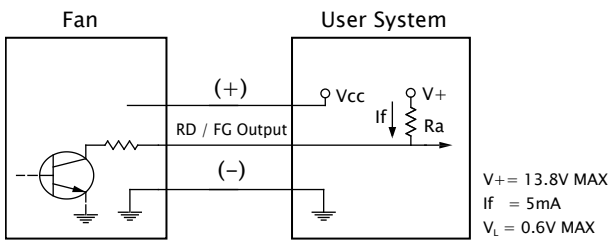

[RD Signal]

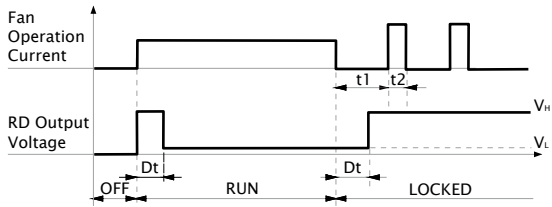

[FG Signal]

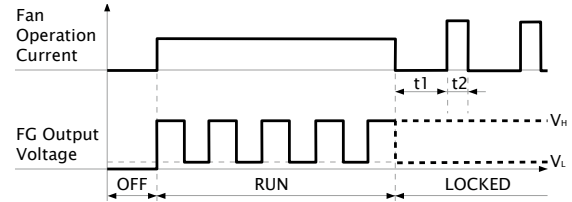
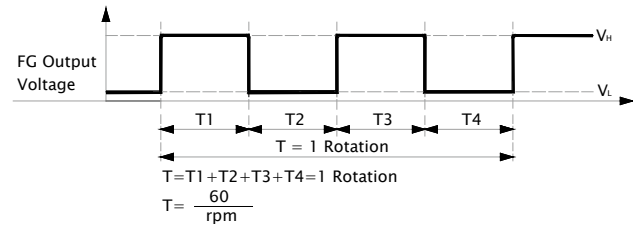

60x60x20 mm

16.0~30.5 CFM



■ Specification

Model	Bearing	Rated Voltage	Power Current	Power Consumption	Speed	Airflow	Static Pressure	Noise	Weight	Curve
	2BALL Sleeve	(VDC)	(mA)	(WATTS)	(RPM)	(CFM)	(inch-H ₂ O)	(dB(A))	(g)	
PE60201BX-0000-A99	☉	12	230	2.76	5500	30.5	0.35	41.0	52.0	1
PE60201B1-0000-A99	☉	12	192	2.30	5000	27.5	0.28	39.0	52.0	2
PE60201B2-0000-A99	☉	12	148	1.78	4400	23.5	0.20	35.0	52.0	3
PE60201B3-0000-A99	☉	12	103	1.24	3600	19.5	0.15	30.0	52.0	4
PE60201B4-0000-A99	☉	12	81	0.97	3000	16.0	0.10	24.0	52.0	5

■ Function R Type : F99 / F Type : G99

■ Air Flow-Static Pressure Characteristics

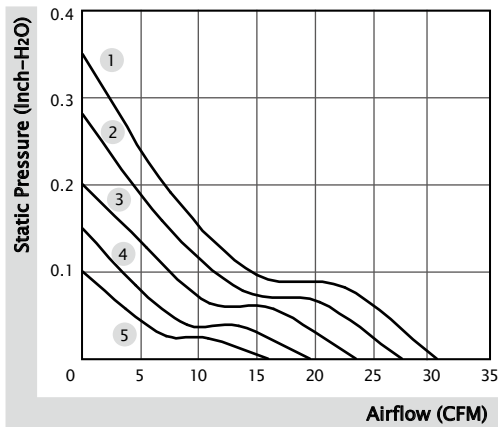

■ External Dimensions(mm)

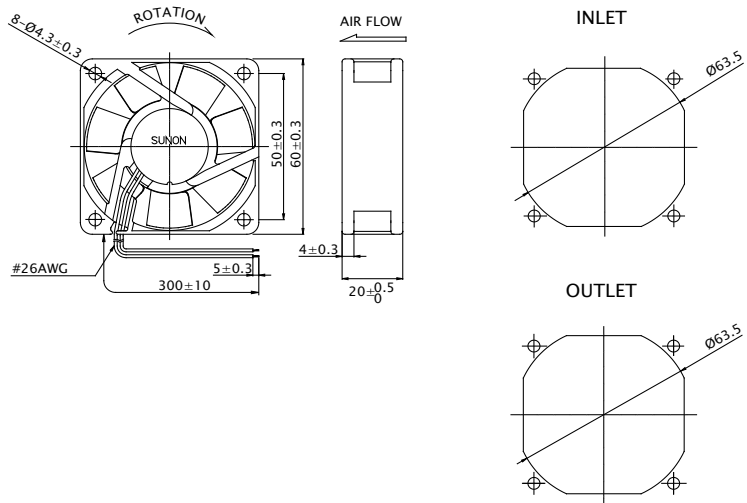

* All model could be customized. Please contact with Sunon Sales.

* Specifications are subject to change without notice. Please Visit SUNON website at www.sunon.com for update information.

■ RD / FG Output Signal

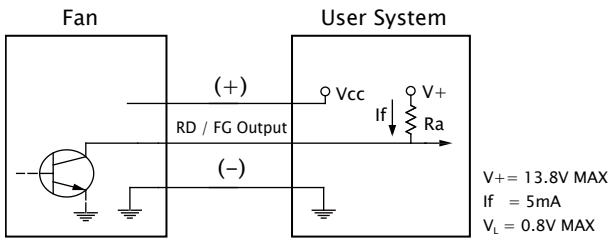

[RD Signal]

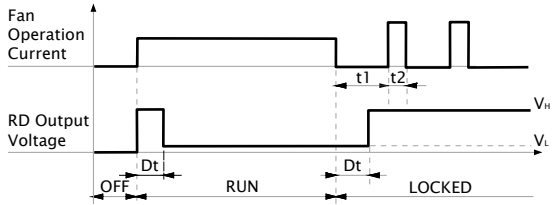

[FG Signal]

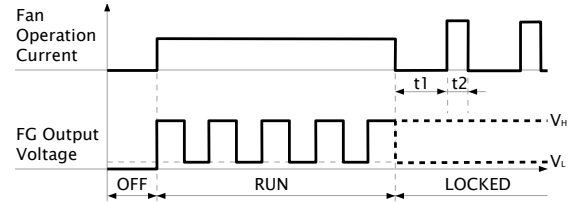
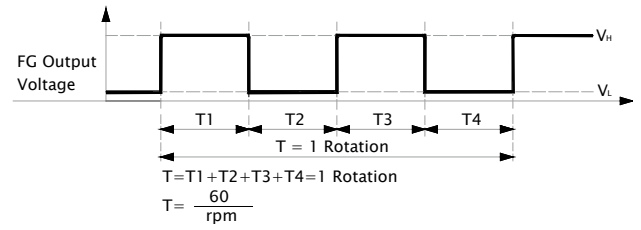

60x60x20 mm

16.5~25.5 CFM



■ Specification

	Bearing	Rated Voltage	Power Current	Power Consumption	Speed	Airflow	Static Pressure	Noise	Weight	Curve
	● VAPO	(VDC)	(mA)	(WATTS)	(RPM)	(CFM)	(inch-H ₂ O)	(dB(A))	(g)	
MF60201VX-10000-A99	●	12	142	1.71	5700	25.5	0.27	39.0	50.0	1
MF60201V1-10000-A99	●	12	100	1.20	5000	23.0	0.21	33.5	50.0	2
MF60201V2-10000-A99	●	12	65	0.78	4200	19.0	0.16	28.0	50.0	3
MF60201V3-10000-A99	●	12	40	0.48	3100	16.5	0.10	21.0	50.0	4
MF60202VX-10000-A99	●	24	75	1.80	5700	25.5	0.27	39.0	50.0	1
MF60202V1-10000-A99	●	24	55	1.32	5000	23.0	0.21	33.5	50.0	2
MF60202V2-10000-A99	●	24	35	0.84	4200	19.0	0.16	28.0	50.0	3
MF60202V3-10000-A99	●	24	22	0.53	3100	16.5	0.10	21.0	50.0	4

■ Function R Type : F99 / F Type : G99

■ Air Flow-Static Pressure Characteristics

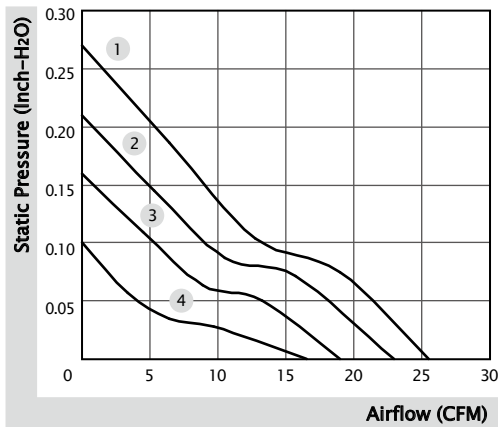

■ External Dimensions(mm)

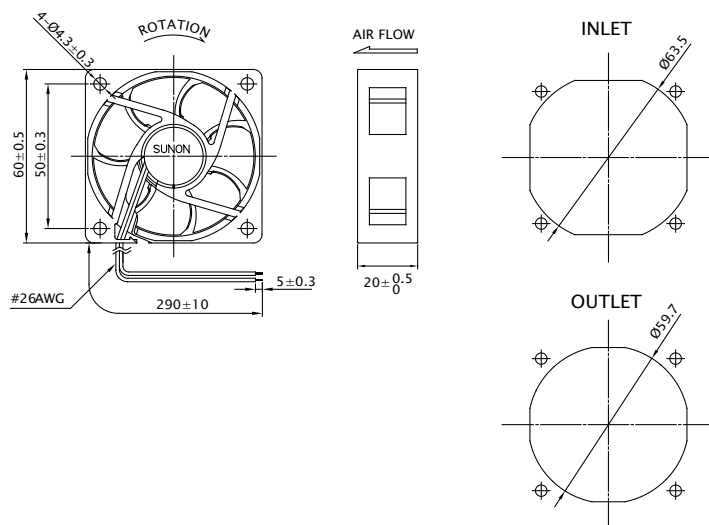

※ All model could be customized. Please contact with Sunon Sales.

※ Specifications are subject to change without notice. Please Visit SUNON website at www.sunon.com for update information.

■ RD / FG Output Signal

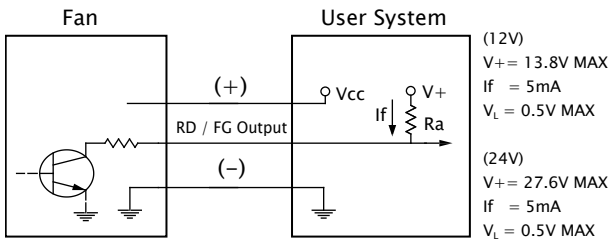

[RD Signal]

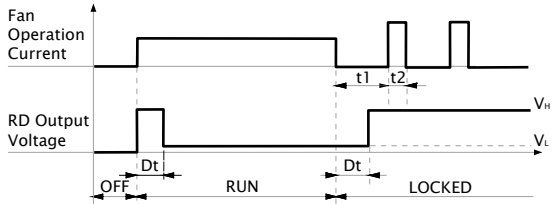

[FG Signal]

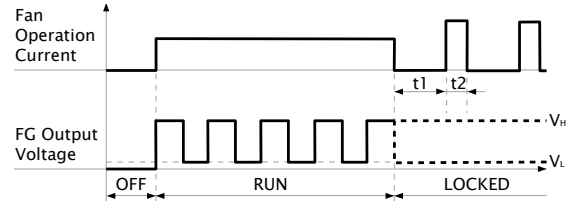
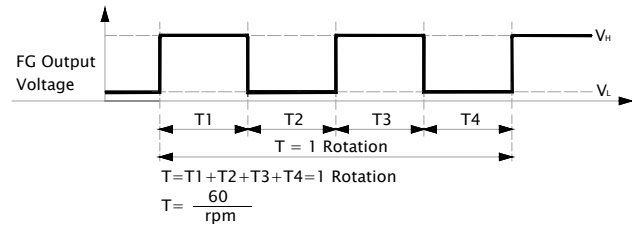

60x60x20 mm

14.1~23.0 CFM



■ Specification

Model	Bearing	Rated Voltage	Power Current	Power Consumption	Speed	Airflow	Static Pressure	Noise	Weight	Curve
	2BALL Sleeve	(VDC)	(mA)	(WATTS)	(RPM)	(CFM)	(inch-H ₂ O)	(dB(A))	(g)	
EE60201B1-0000-999	☉	12	135	1.62	4500	23.0	0.18	34.5	52.0	1
EE60201B2-0000-999	☉	12	95	1.14	3700	19.0	0.14	29.0	52.0	2
EE60201B3-0000-999	☉	12	70	0.84	3000	14.1	0.09	24.5	52.0	3
EF60202B1-0000-A99	☉	24	60	1.44	4500	23.0	0.18	34.5	52.0	1
EF60202B2-0000-A99	☉	24	38	0.92	3700	19.0	0.14	29.0	52.0	2
EF60202B3-0000-A99	☉	24	23	0.56	3000	14.1	0.09	24.5	52.0	3

■ Function (12V) Auto Restart : A99 / R Type : F99 / F Type : C99, G99
 (24V) R Type : F99 / F Type : G99

■ Air Flow-Static Pressure Characteristics

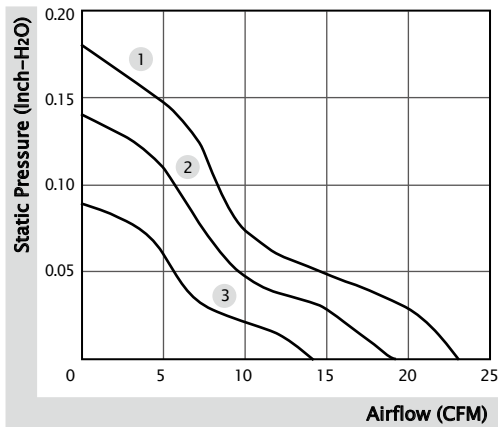

■ External Dimensions(mm)

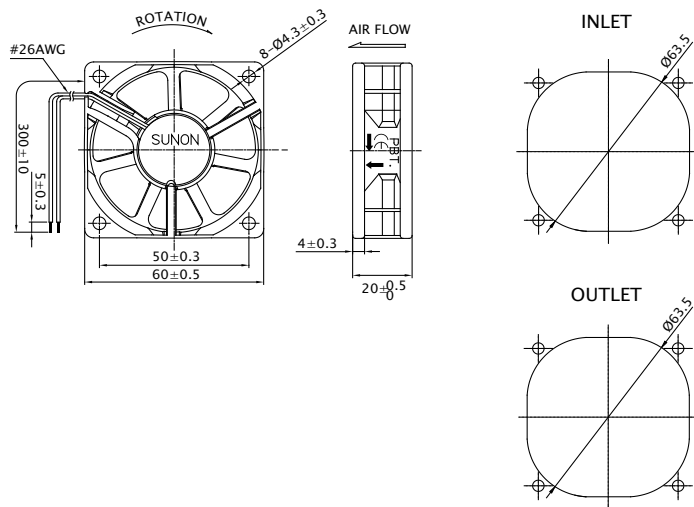

※ All model could be customized. Please contact with Sunon Sales.

※ Specifications are subject to change without notice. Please Visit SUNON website at www.sunon.com for update information.

RD / FG Output Signal

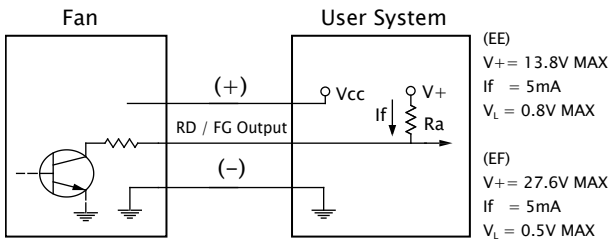

[RD Signal]

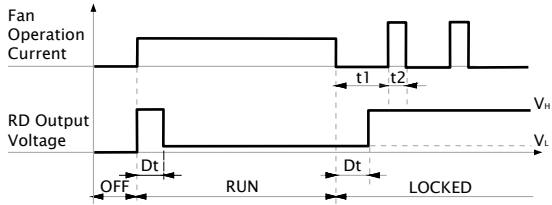

[FG Signal]

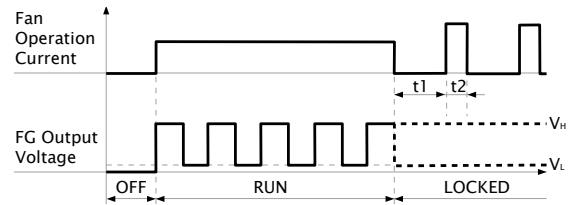
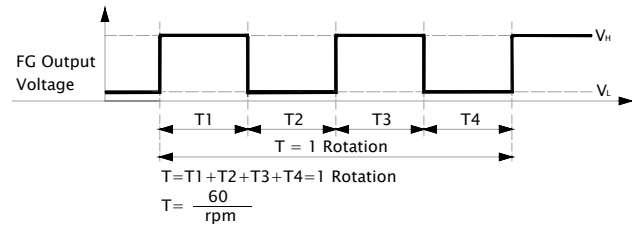

Non-Auto Restart (C99) FG Output Signal

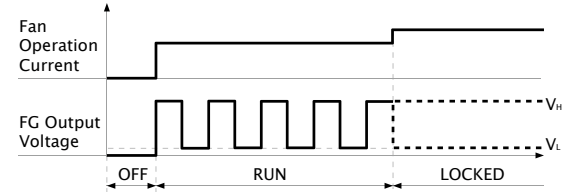
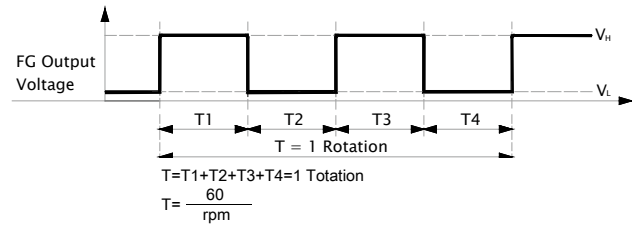
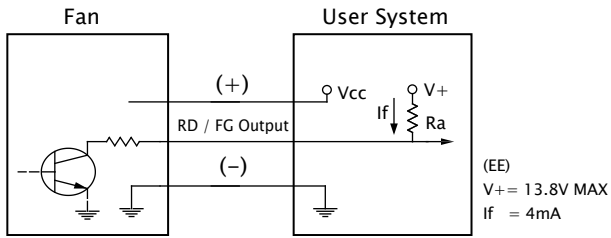

60x60x20 mm

16.8~22.6 CFM



■ Specification

Model	Bearing	Rated Voltage	Power Current	Power Consumption	Speed	Airflow	Static Pressure	Noise	Weight	Curve
	2BALL Sleeve	(VDC)	(mA)	(WATTS)	(RPM)	(CFM)	(inch-H ₂ O)	(dB(A))	(g)	
EE60201S1-10000-999	○	12	115	1.38	4700	22.6	0.18	32.5	50.0	1
EE60201S2-10000-999	○	12	82	0.99	3900	18.5	0.14	26.3	50.0	2
EE60201S3-10000-999	○	12	58	0.70	3200	16.8	0.10	22.0	50.0	3

■ Function F Type : C99

■ Air Flow-Static Pressure Characteristics

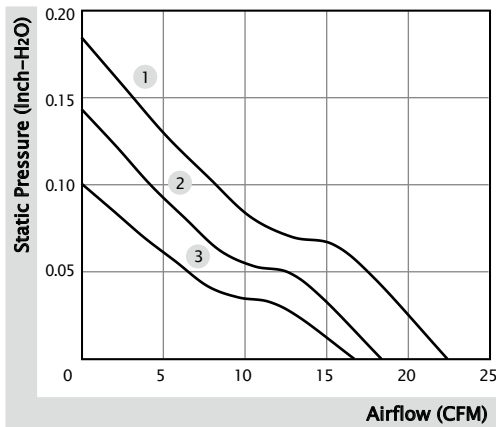

■ External Dimensions(mm)

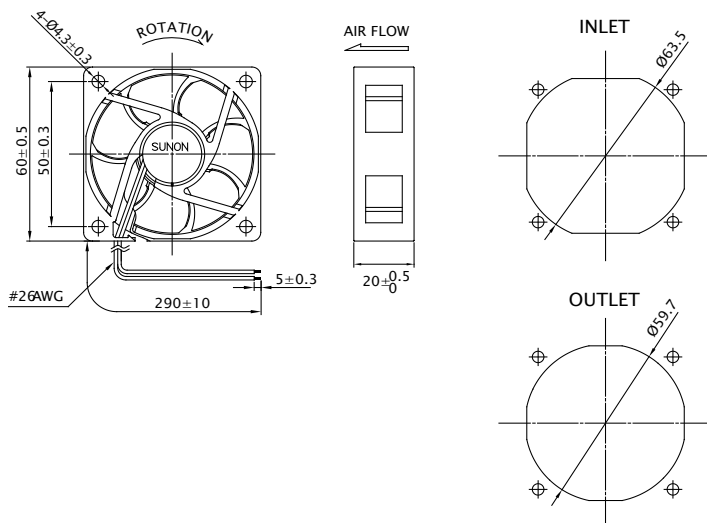

※ All model could be customized. Please contact with Sunon Sales.

※ Specifications are subject to change without notice. Please Visit SUNON website at www.sunon.com for update information.

■ RD / FG Output Signal

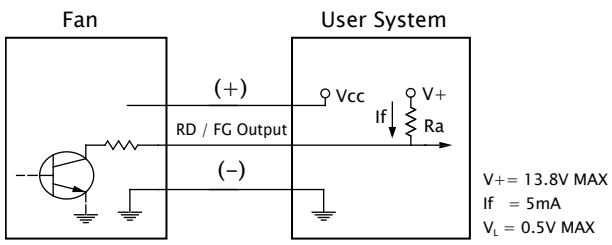

[FG Signal]

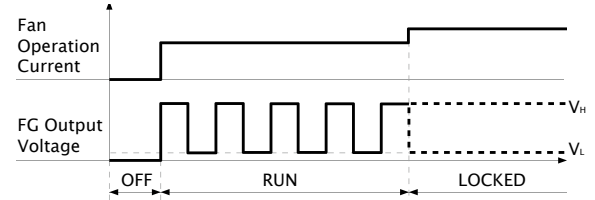
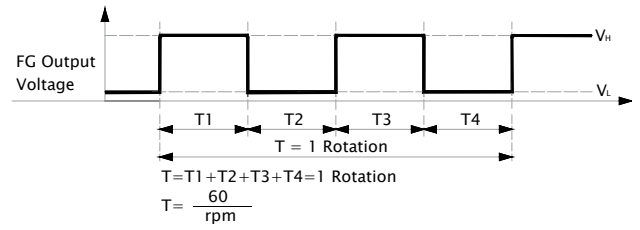

60x60x25 mm

29.0~40.0 CFM



■ Specification

Model	Bearing	Rated Voltage	Power Current	Power Consumption	Speed	Airflow	Static Pressure	Noise	Weight	Curve
	2BALL Sleeve	(VDC)	(mA)	(WATTS)	(RPM)	(CFM)	(inch-H ₂ O)	(dB(A))	(g)	
PE60251BX-0000-A99	☉	12	370	4.44	7600	40.0	0.64	46.0	71.0	1
PE60251B1-0000-A99	☉	12	297	3.57	6900	36.0	0.54	44.0	71.0	2
PE60251B2-0000-A99	☉	12	232	2.79	6100	31.5	0.42	42.0	71.0	3
PE60251B3-0000-A99	☉	12	197	2.37	5600	29.0	0.36	38.0	71.0	4
PE60252BX-0000-A99	☉	24	190	4.56	7600	40.0	0.64	46.0	75.0	1
PE60252B1-0000-A99	☉	24	155	3.72	6900	36.0	0.54	44.0	75.0	2
PE60252B2-0000-A99	☉	24	121	2.91	6100	31.5	0.42	42.0	75.0	3
PE60252B3-0000-A99	☉	24	104	2.50	5600	29.0	0.36	38.0	75.0	4

■ Function R Type : F99 / F Type : G99

■ Air Flow-Static Pressure Characteristics

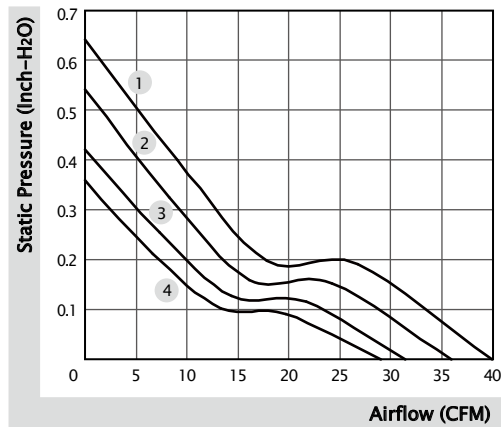

■ External Dimensions(mm)

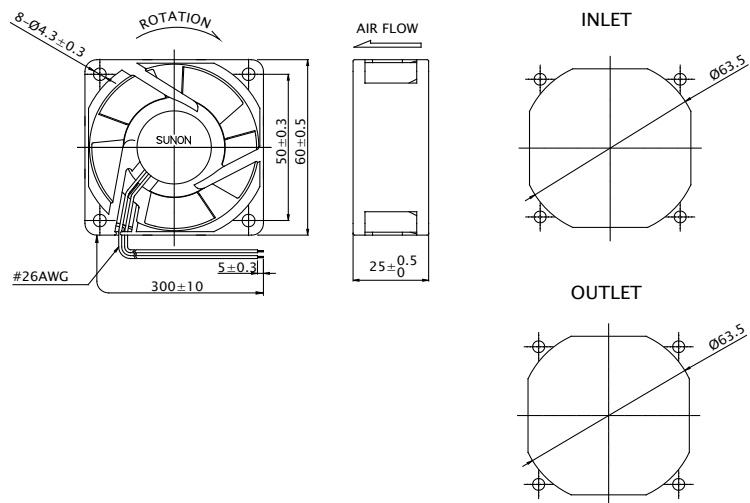

※ All model could be customized. Please contact with Sunon Sales.

※ Specifications are subject to change without notice. Please Visit SUNON website at www.sunon.com for update information.

■ RD / FG Output Signal

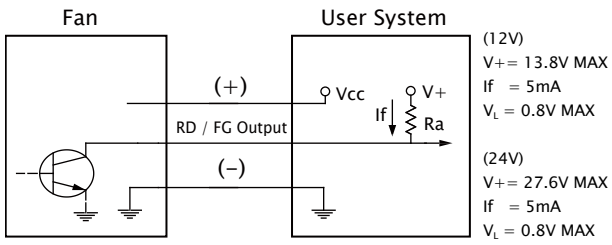

[RD Signal]

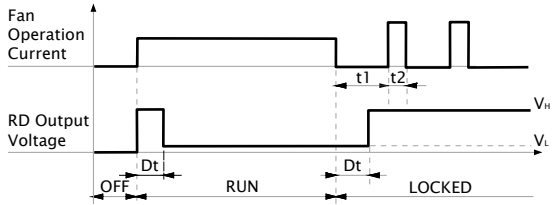

[FG Signal]

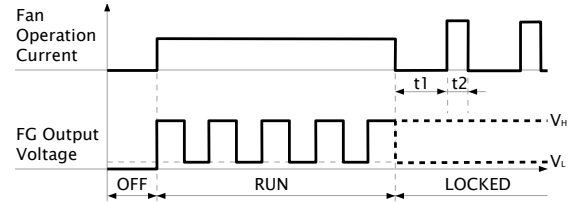
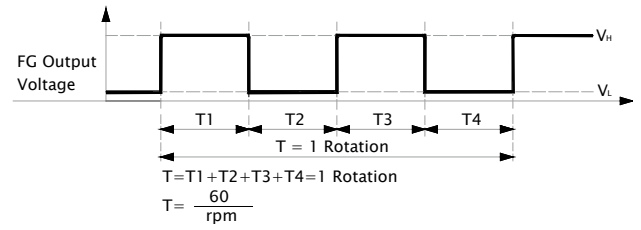

60x60x25 mm

16.0~27.0 CFM



■ Specification

	Bearing	Rated Voltage	Power Current	Power Consumption	Speed	Airflow	Static Pressure	Noise	Weight	Curve
	● VAPO	(VDC)	(mA)	(WATTS)	(RPM)	(CFM)	(inch-H ₂ O)	(dB(A))	(g)	
MF60251VX-10000-A99	●	12	130	1.56	5200	27.0	0.31	31.2	45.0	1
MF60251V1-10000-A99	●	12	75	0.90	4500	23.5	0.21	27.0	45.0	2
MF60251V2-10000-A99	●	12	72	0.87	3800	19.3	0.15	22.0	45.0	3
MF60251V3-10000-A99	●	12	44	0.53	3100	16.0	0.10	16.7	45.0	4
MF60252VX-10000-A99	●	24	80	1.92	5200	27.0	0.31	31.2	45.0	1
MF60252V1-10000-A99	●	24	50	1.20	4500	23.5	0.21	27.0	45.0	2
MF60252V2-10000-A99	●	24	30	0.72	3800	19.3	0.15	22.0	45.0	3
MF60252V3-10000-A99	●	24	22	0.53	3100	16.0	0.10	16.7	45.0	4
Model	○ 2BALL Sleeve	(VDC)	(mA)	(WATTS)	(RPM)	(CFM)	(inch-H ₂ O)	(dB(A))	(g)	
EE60251S1-10000-999	○	12	122	1.47	4500	23.5	0.21	27.0	45.0	2
EE60251S2-10000-999	○	12	85	1.02	3800	19.3	0.15	22.0	45.0	3
EE60251S3-10000-999	○	12	60	0.72	3100	16.0	0.10	16.7	45.0	4
EF60252S1-10000-A99	○	24	50	1.20	4500	23.5	0.21	27.0	45.0	2

- Function (MF Series) R Type : F99 / F Type : G99
- (EE Series) F Type : C99
- (EF Series) F Type : G99

■ Air Flow-Static Pressure Characteristics

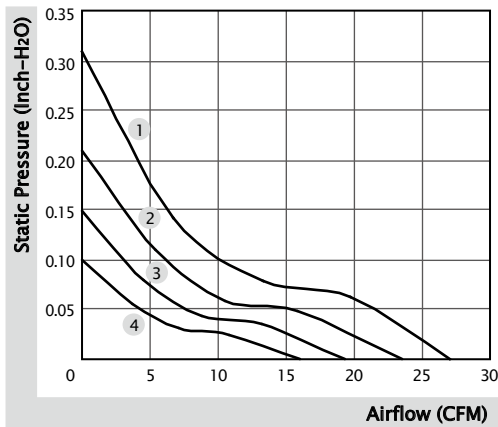

■ External Dimensions(mm)

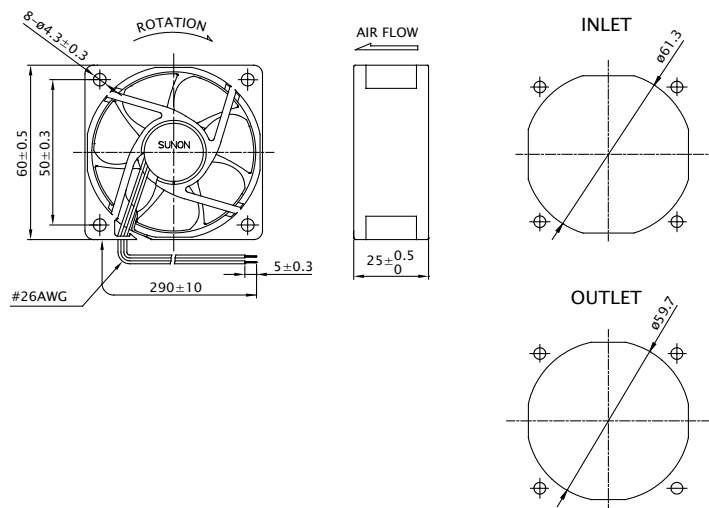

※ All model could be customized. Please contact with Sunon Sales.
 ※ Specifications are subject to change without notice. Please Visit SUNON website at www.sunon.com for update information.

■ RD / FG Output Signal

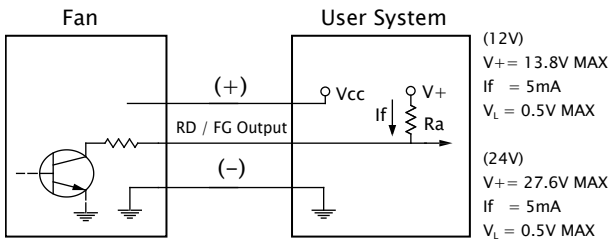

[RD Signal]

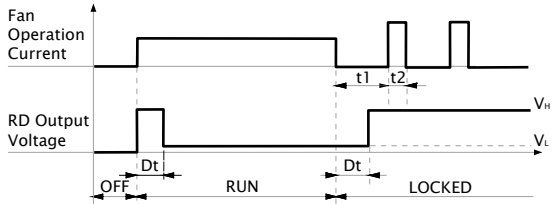

[FG Signal]

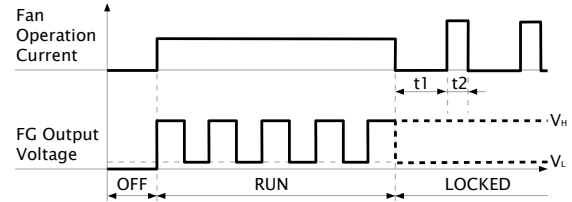
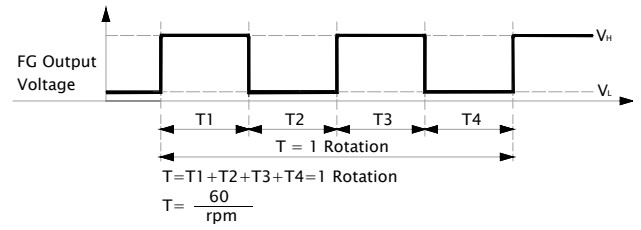

60x60x25 mm

13.9~23.5 CFM



■ Specification

Model	Bearing	Rated Voltage	Power Current	Power Consumption	Speed	Airflow	Static Pressure	Noise	Weight	Curve
	2BALL Sleeve	(VDC)	(mA)	(WATTS)	(RPM)	(CFM)	(inch-H ₂ O)	(dB(A))	(g)	
EE60251B1-0000-999	☉	12	120	1.44	4500	23.5	0.21	34.5	50.0	1
EE60251B2-0000-999	☉	12	78	0.94	3800	19.3	0.15	30.0	50.0	2
EE60251B3-0000-999	☉	12	58	0.70	3000	13.9	0.08	20.0	50.0	3
EE60252B1-0000-A99	☉	24	70	1.68	4500	23.5	0.21	34.5	50.0	1
EE60252B2-0000-A99	☉	24	47	1.13	3800	19.3	0.15	30.0	50.0	2
EE60252B3-0000-A99	☉	24	30	0.72	3000	13.9	0.08	20.0	50.0	3

■ Function (12V) Auto Restart : A99 / R Type : F99 / F Type : C99, G99
 (24V) R Type : F99 / F Type : G99

■ Air Flow-Static Pressure Characteristics

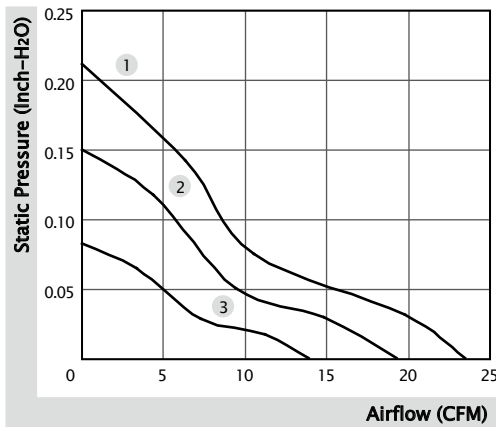

■ External Dimensions(mm)

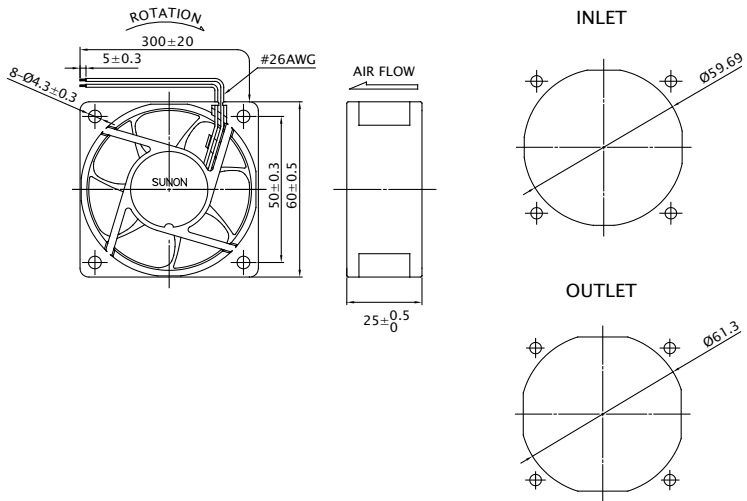

※ All model could be customized. Please contact with Sunon Sales.

※ Specifications are subject to change without notice. Please Visit SUNON website at www.sunon.com for update information.

■ RD / FG Output Signal

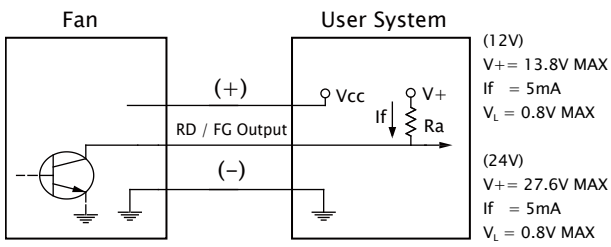

[RD Signal]

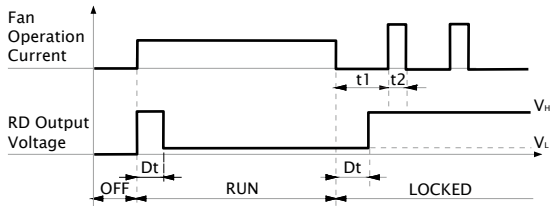

[FG Signal]

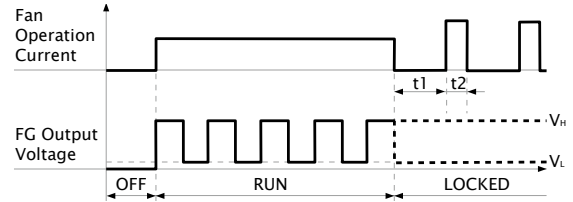
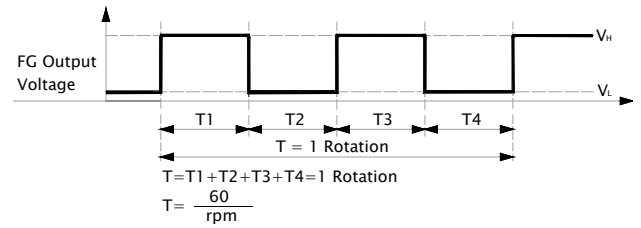

■ Non-Auto Restart (C99) FG Output Signal

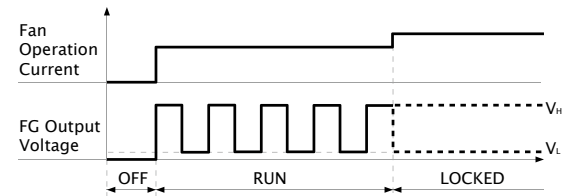
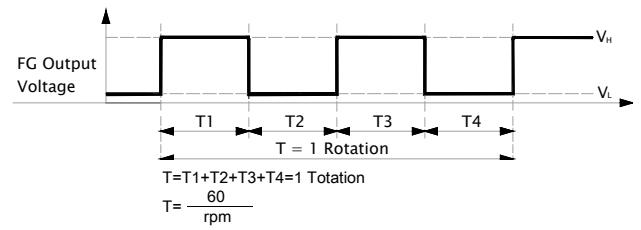
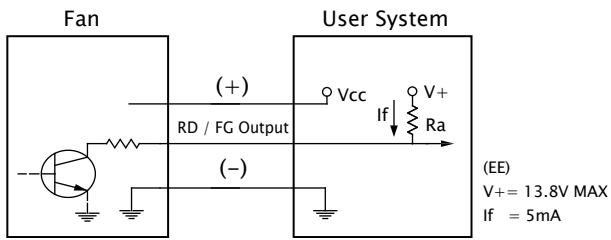

60x60x25 mm

13.8 CFM



■ Specification

	Bearing	Rated Voltage	Power Current	Power Consumption	Speed	Airflow	Static Pressure	Noise	Weight	Curve
	● VAPO	(VDC)	(mA)	(WATTS)	(RPM)	(CFM)	(inch-H ₂ O)	(dB(A))	(g)	
HA60251V4-10000-A99	●	12	20	0.24	2500	13.8	0.06	10.7	45.0	1

■ Function F Type : G99

■ Air Flow-Static Pressure Characteristics

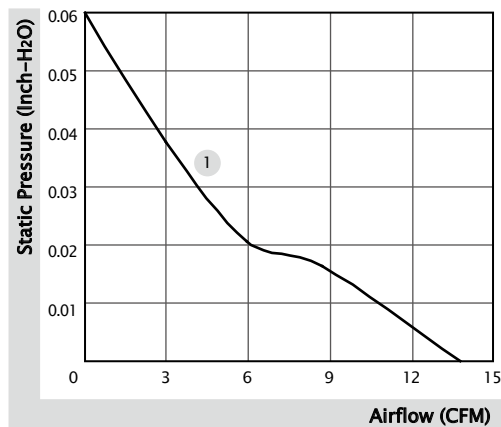

■ External Dimensions(mm)

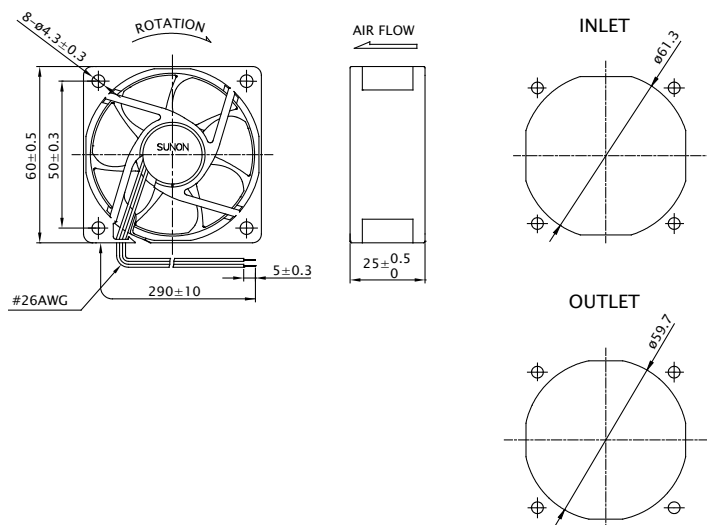

※ All model could be customized. Please contact with Sunon Sales.

※ Specifications are subject to change without notice. Please Visit SUNON website at www.sunon.com for update information.

■ RD / FG Output Signal

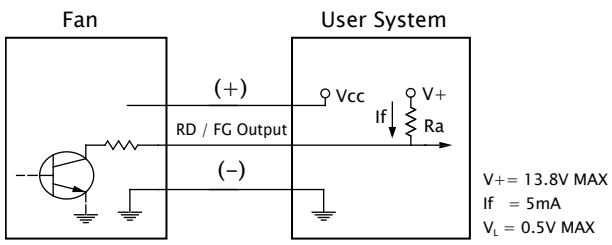

[FG Signal]

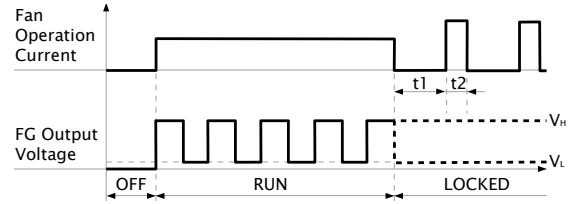
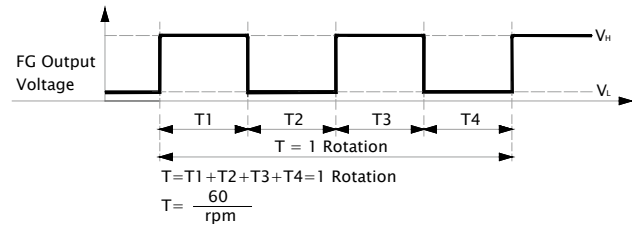

60x60x38 mm

60.6~75.2 CFM



■ Specification

Model	Bearing	Rated Voltage	Power Current	Power Consumption	Speed	Airflow	Static Pressure	Noise	Weight	Curve
	2BALL Sleeve	(VDC)	(mA)	(WATTS)	(RPM)	(CFM)	(inch-H ₂ O)	(dB(A))	(g)	
PF60381BX-0000-A99	☉	12	2500	30.00	16500	75.2	3.28	67.6	127.0	1
PF60381B1-0000-A99	☉	12	1200	14.40	13200	60.6	2.13	61.2	127.0	2

■ Function R Type : F99 / F Type : G99 / PWM : H99, Q99, S99

■ Air Flow-Static Pressure Characteristics

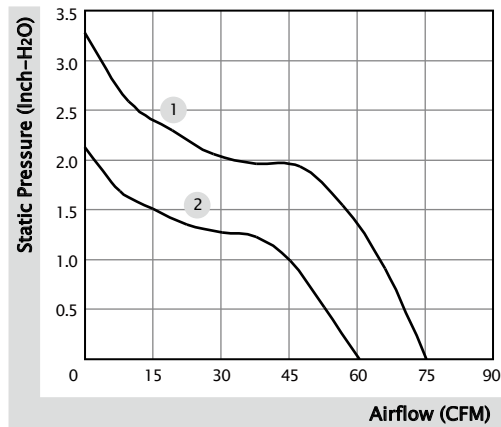

■ External Dimensions(mm)

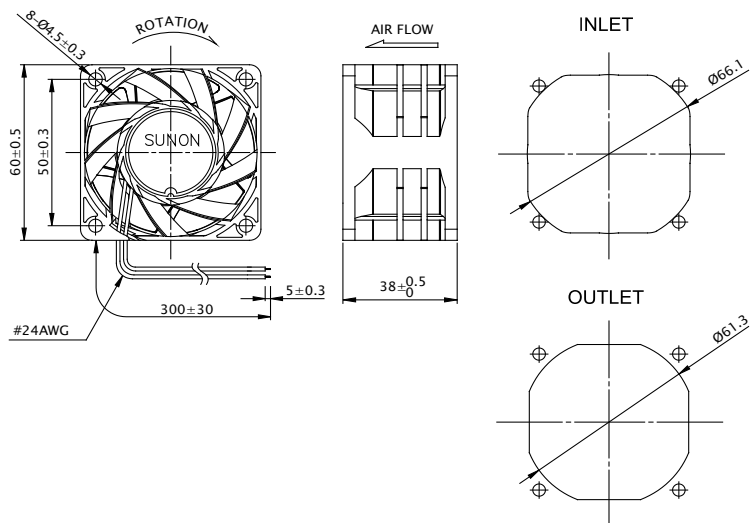

* All model could be customized. Please contact with Sunon Sales.

* Specifications are subject to change without notice. Please Visit SUNON website at www.sunon.com for update information.

■ RD / FG Output Signal

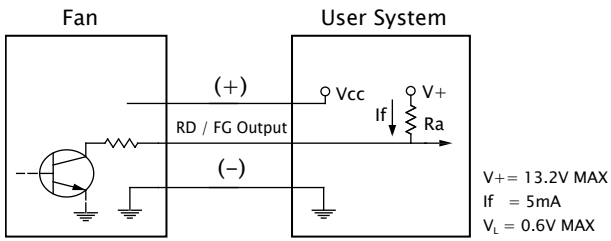

[RD Signal]

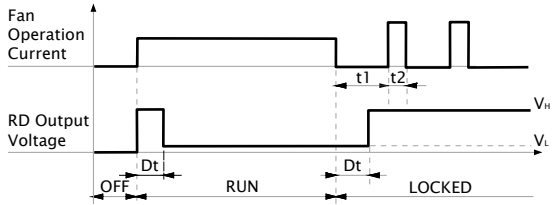

[FG Signal]

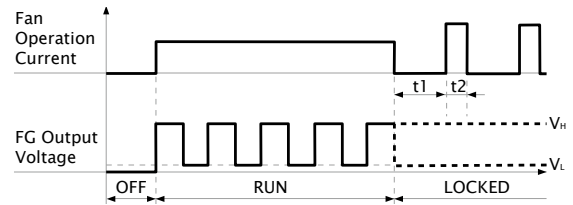
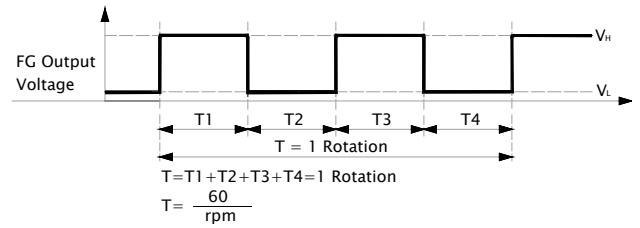

■ PWM Input Signal

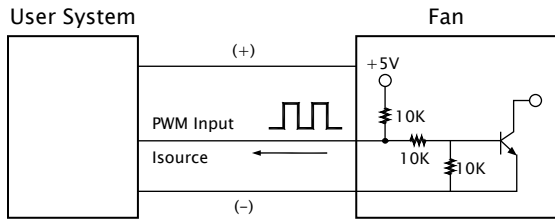

PWM FREQUENCY: 25KHZ
 Isource=0.5mA at PWM Input Voltage 0V
 The speed is default to be maximum if PWM input pin is unconnected.
 Min. start up duty cycle is 10%.

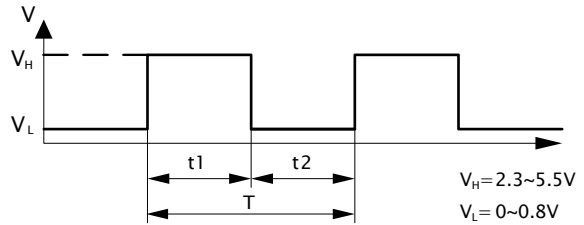

1. Period : $T = \frac{1}{f_{PWM}} = t1 + t2(\text{sec})$

2. Duty Cycle (D.C.) : $\frac{t1}{t1+t2} \times 100 = \frac{t1}{T} \times 100(\%)$

■ PWM Curve

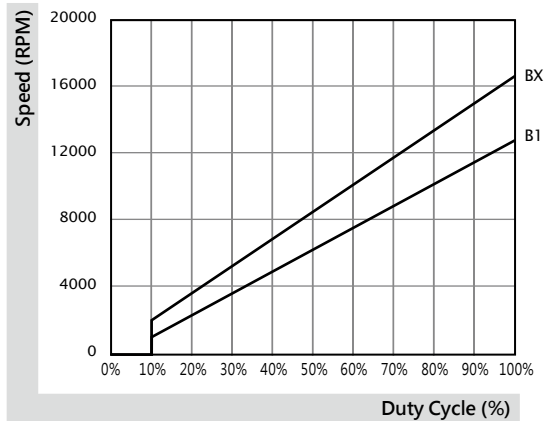

60x60x38 mm

54.1~67.8 CFM



■ Specification

Model	Bearing	Rated Voltage	Power Current	Power Consumption	Speed	Airflow	Static Pressure	Noise	Weight	Curve
	2BALL Sleeve	(VDC)	(mA)	(WATTS)	(RPM)	(CFM)	(inch-H ₂ O)	(dB(A))	(g)	
VF60381BX-0000-A9H	☉	12	1900	22.80	22800	67.8	4.84	64.1	120.0	1
VF60381B1-0000-A9H	☉	12	1000	12.00	18300	54.1	4.23	60.9	120.0	2
VF60384BX-10000-A9H	☉	48	460	22.08	22800	67.8	4.84	64.1	120.0	1
VF60384B1-10000-A9H	☉	48	265	12.72	18300	54.1	4.23	60.9	120.0	2

■ Function (12V) R Type : F9H / F Type : G9H / PWM : H9H, Q9H, S9H
 (48V) R Type : F9H / F Type : G9H / PWM : Q9H, S9H

■ Air Flow-Static Pressure Characteristics

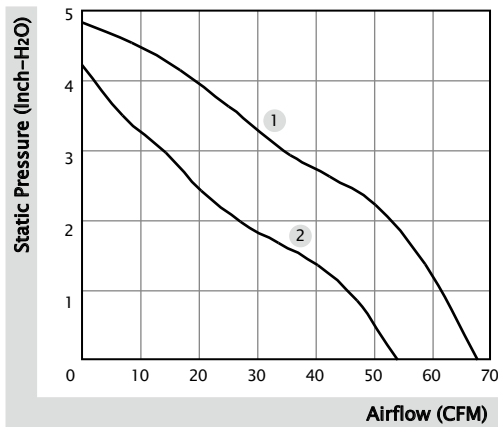

■ External Dimensions(mm)

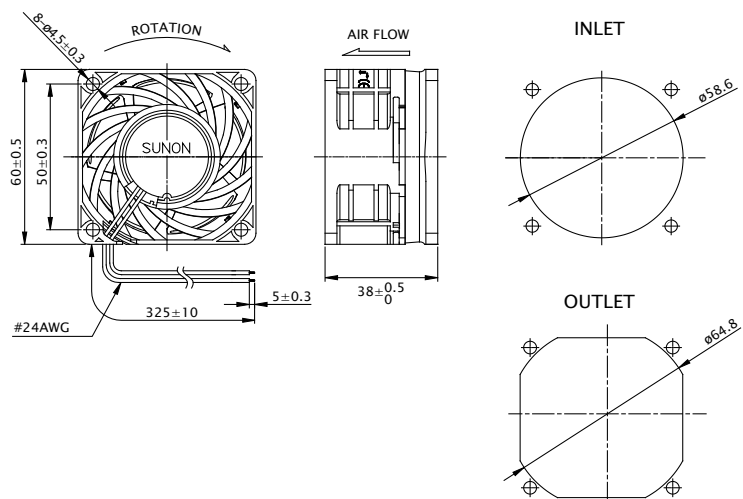

※ All model could be customized. Please contact with Sunon Sales.

※ Specifications are subject to change without notice. Please Visit SUNON website at www.sunon.com for update information.

■ RD / FG Output Signal

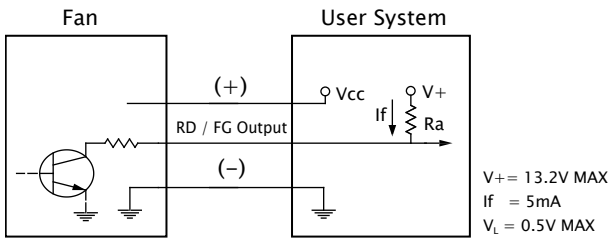

[RD Signal]

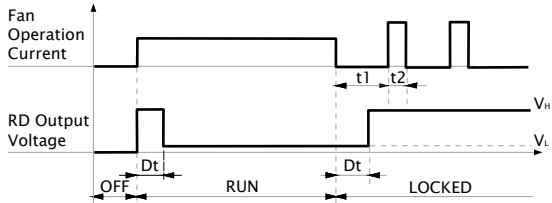

[FG Signal]

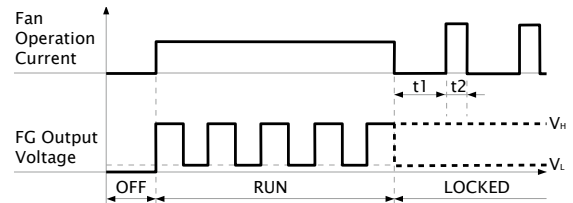
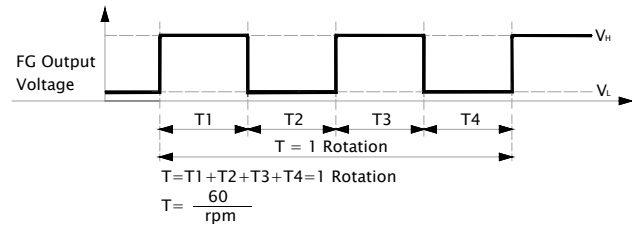

■ PWM Input Signal

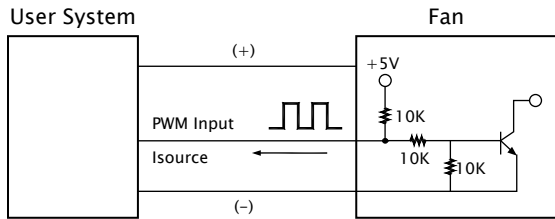

PWM FREQUENCY: 25KHZ
 Isource=0.5mA at PWM Input 0V
 The speed is default to be maximum if PWM input pin is unconnected.
 Min. start up duty cycle is 10%.

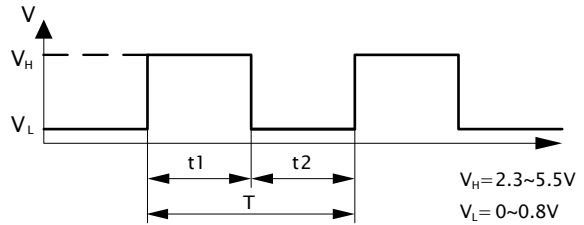

1. Period : $T = \frac{1}{f_{PWM}} = t1 + t2(\text{sec})$
2. Duty Cycle (D.C.) : $\frac{t1}{t1+t2} \times 100 = \frac{t1}{T} \times 100(\%)$

■ PWM Curve

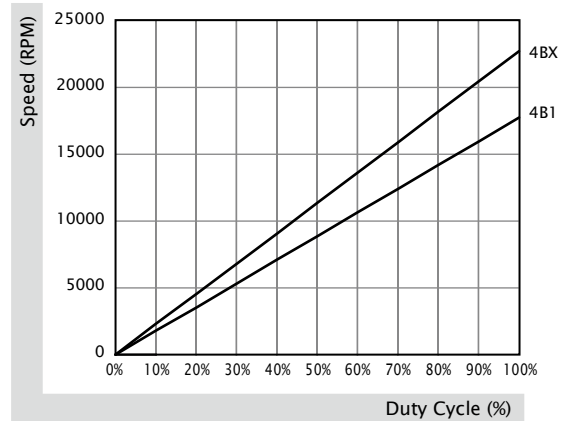
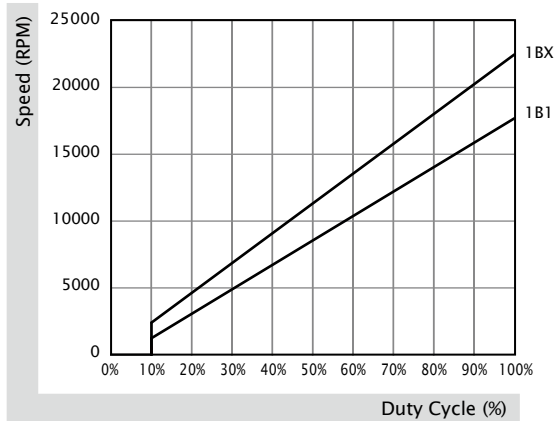

60x60x38 mm

41.5~56.5 CFM



■ Specification

	Bearing	Rated Voltage	Power Current	Power Consumption	Speed	Airflow	Static Pressure	Noise	Weight	Curve
	● VAPO	(VDC)	(mA)	(WATTS)	(RPM)	(CFM)	(inch-H ₂ O)	(dB(A))	(g)	
PMD2406PMB1-A (2).GN	●	24	430	10.3	8000	56.5	0.92	56.0	90.0	1
PMD2406PMB2-A (2).GN	●	24	310	7.4	7000	49.2	0.71	52.0	90.0	2
PMD2406PMB3-A (2).GN	●	24	220	5.3	6000	41.5	0.53	47.0	90.0	3

■ Function R Type : (2).R.GN / F Type : (2).F.GN

■ Air Flow-Static Pressure Characteristics

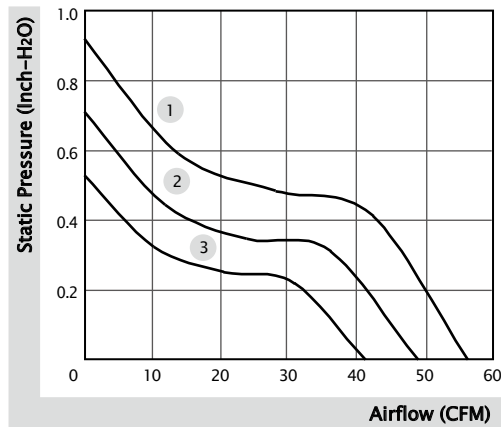

■ External Dimensions(mm)

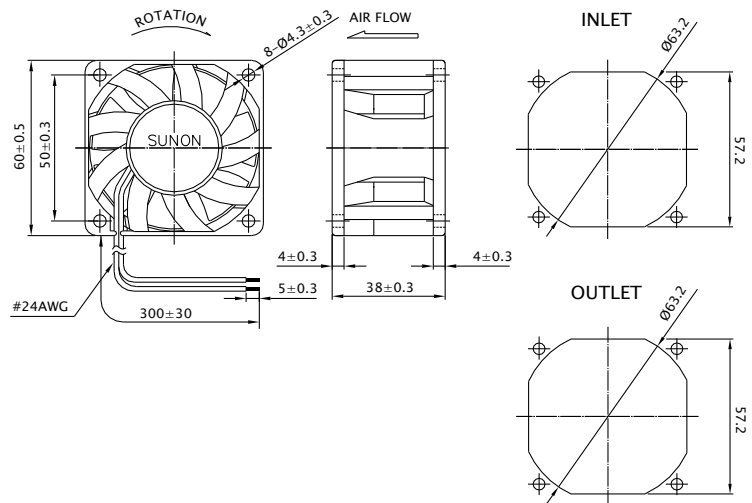

※ All model could be customized. Please contact with Sunon Sales.

※ Specifications are subject to change without notice. Please Visit SUNON website at www.sunon.com for update information.

■ RD / FG Output Signal

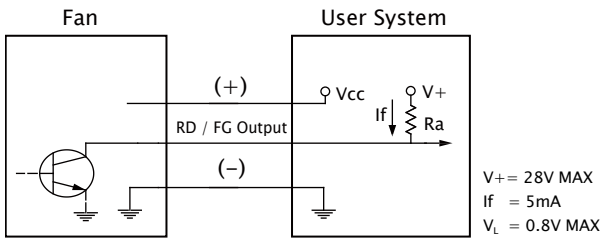

[RD Signal]

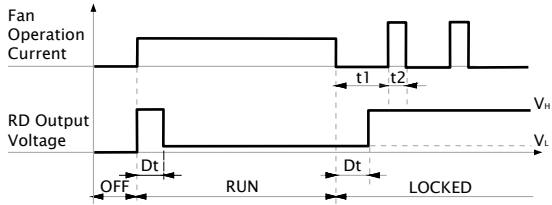

[FG Signal]

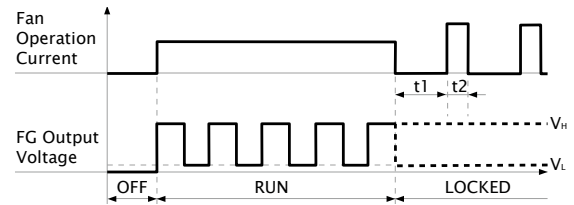
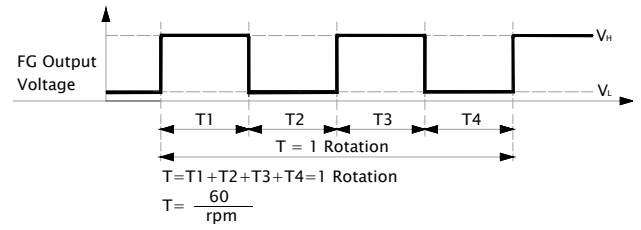

60x60x56 mm

58.5~72.9 CFM



■ Specification

Model	Bearing	Rated Voltage	Power Current	Power Consumption	Speed	Airflow	Static Pressure	Noise	Weight	Curve
	2BALL Sleeve	(VDC)	(mA)	(WATTS)	(RPM)	(CFM)	(inch-H ₂ O)	(dB(A))	(g)	
PF60561BX-0000-A9H	☉	12	2500	30.0	15300/14300	72.9	3.44	71.7	172.0	1
PF60561B1-0000-A9H	☉	12	1400	16.8	12300/11500	58.5	2.35	67.0	172.0	2

■ Function R Type : F9H / F Type : G9H / PWM : H9H, Q9H, S9H

■ Air Flow-Static Pressure Characteristics

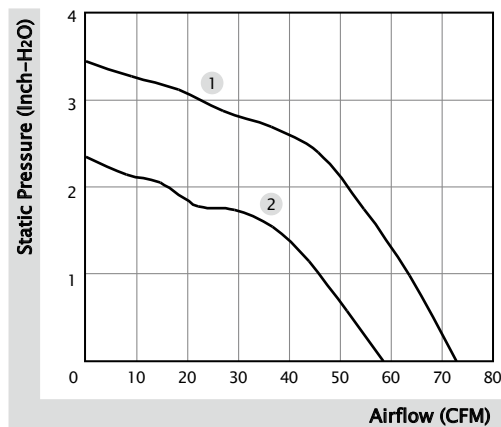

■ External Dimensions(mm)

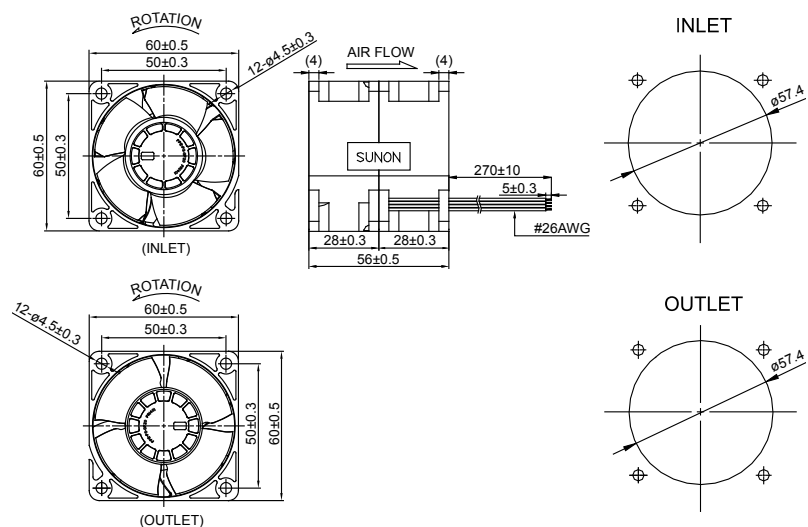

※ All model could be customized. Please contact with Sunon Sales.

※ Specifications are subject to change without notice. Please Visit SUNON website at www.sunon.com for update information.

■ RD / FG Output Signal

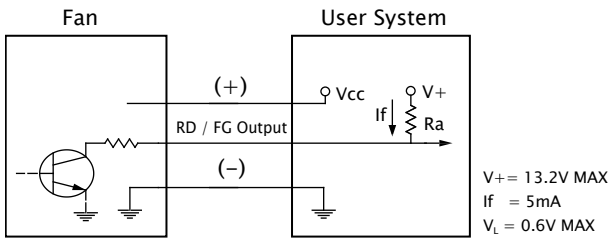

[RD Signal]

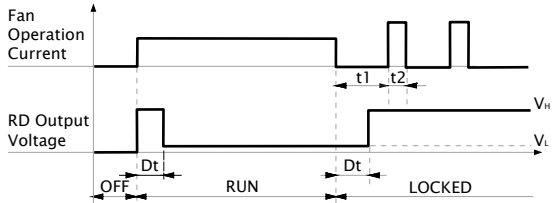

[FG Signal]

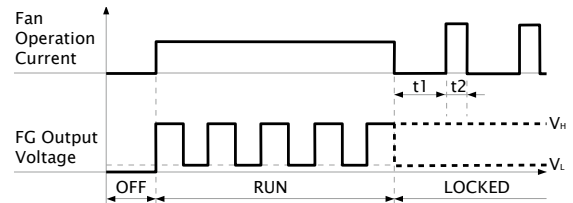
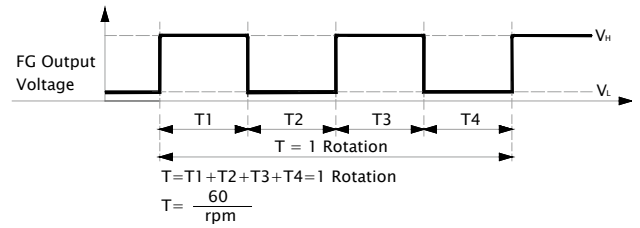

■ PWM Input Signal

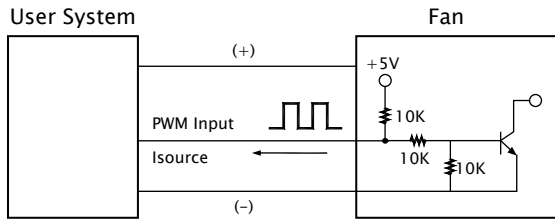

PWM FREQUENCY: 25KHZ
 Isource=0.5mA at PWM Input Voltage 0V
 The speed is default to be maximum if PWM input pin is unconnected.
 Min. start up duty cycle is 10%.

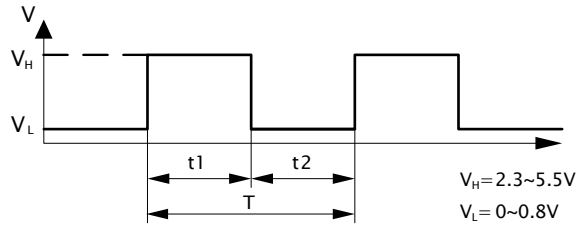

1. Period : $T = \frac{1}{f_{PWM}} = t1 + t2(\text{sec})$
2. Duty Cycle (D.C.) : $\frac{t1}{t1+t2} \times 100 = \frac{t1}{T} \times 100(\%)$

■ PWM Curve

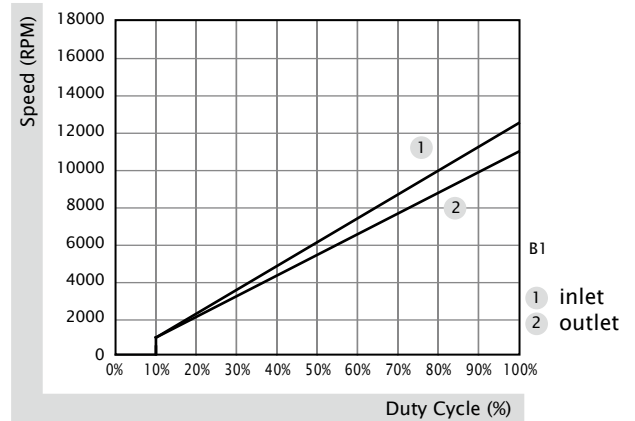
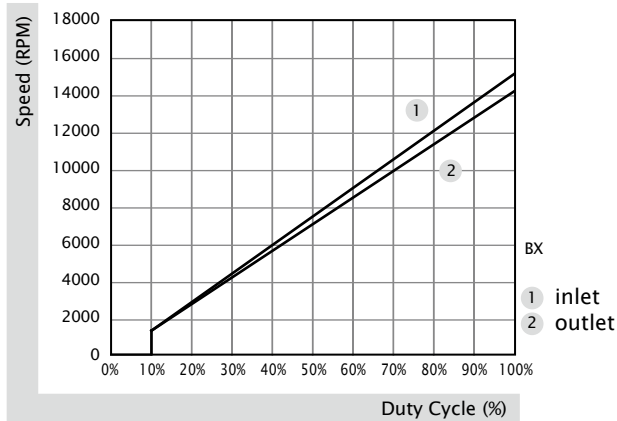

60x60x76 mm

58.7~73.2 CFM

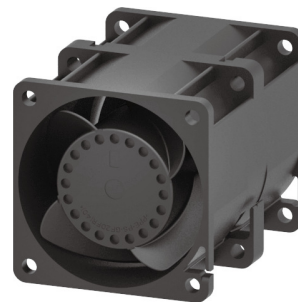

■ Specification

Model	Bearing	Rated Voltage	Power Current	Power Consumption	Speed	Airflow	Static Pressure	Noise	Weight	Curve
	2BALL Sleeve	(VDC)	(mA)	(WATTS)	(RPM)	(CFM)	(inch-H ₂ O)	(dB(A))	(g)	
PF60761BX-0000-A99		12	2800	33.60	18200/14700	73.2	3.96	68.6	270.0	1
PF60761B1-0000-A99		12	1600	19.20	14600/11700	58.7	2.54	62.8	270.0	2

■ Function R Type : F99 / F Type : G99 / PWM : H99, Q99, S99

■ Air Flow-Static Pressure Characteristics

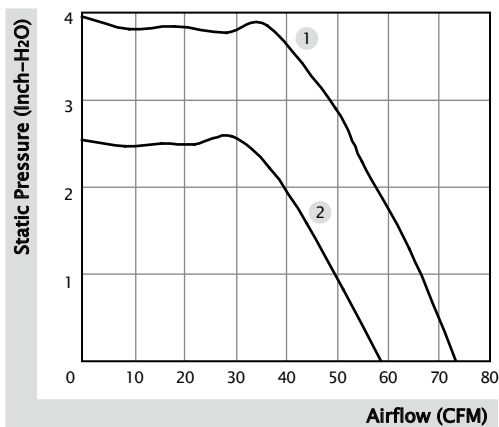

■ External Dimensions(mm)

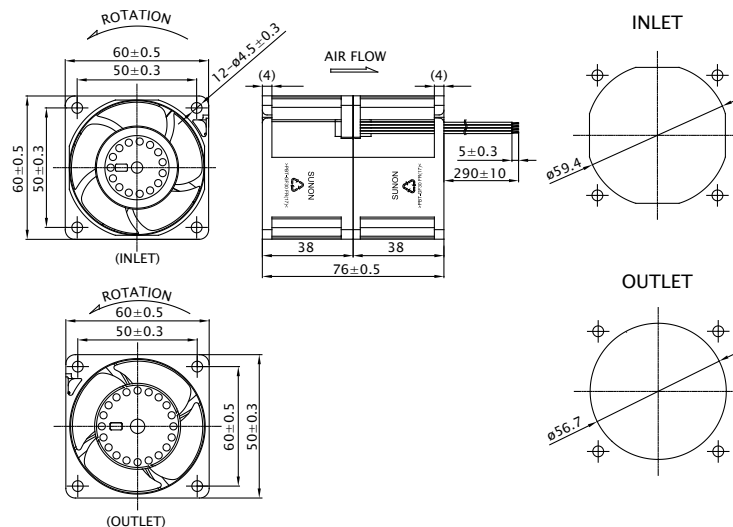

※ All model could be customized. Please contact with Sunon Sales.

※ Specifications are subject to change without notice. Please Visit SUNON website at www.sunon.com for update information.

■ RD / FG Output Signal

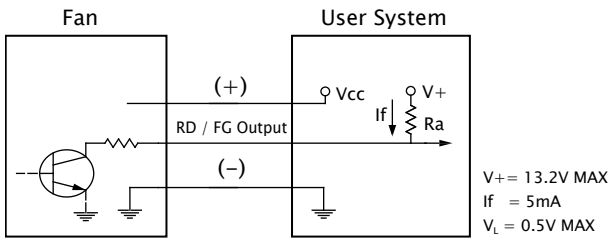

[RD Signal]

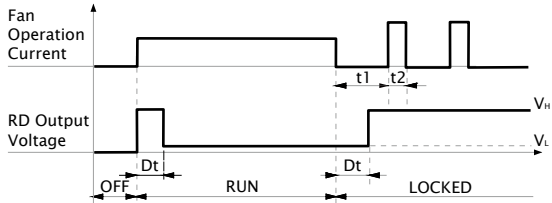

[FG Signal]

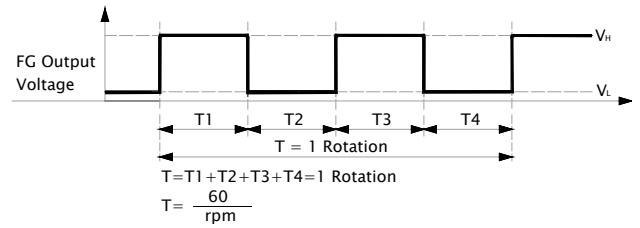

■ PWM Input Signal

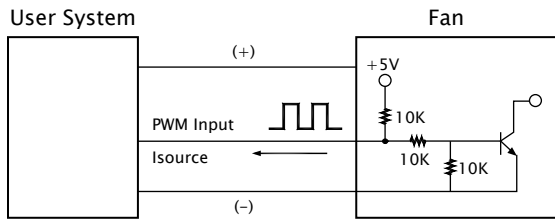

PWM FREQUENCY: 25KHZ
 Isource=0.5mA at PWM Input Voltage 0V
 The speed is default to be maximum if PWM input pin is unconnected.
 Min. start up duty cycle is 10%.

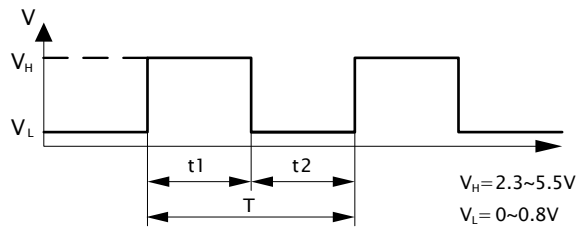

1. Period : $T = \frac{1}{f_{PWM}} = t1 + t2(\text{sec})$
2. Duty Cycle (D.C.) : $\frac{t1}{t1+t2} \times 100 = \frac{t1}{T} \times 100(\%)$

■ PWM Curve

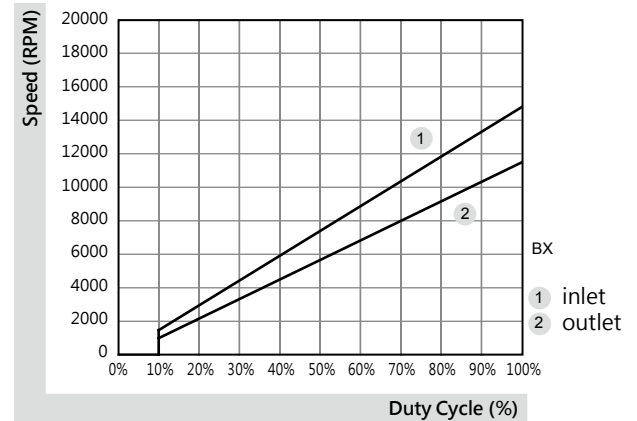
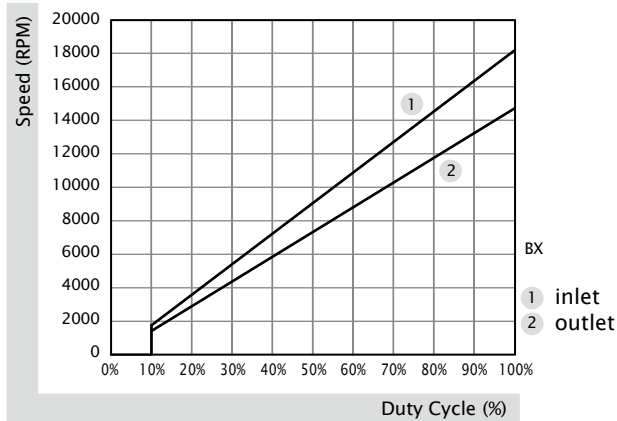

70x70x15 mm

19.0~27.0 CFM



■ Specification

	Bearing	Rated Voltage	Power Current	Power Consumption	Speed	Airflow	Static Pressure	Noise	Weight	Curve
	● VAPO	(VDC)	(mA)	(WATTS)	(RPM)	(CFM)	(inch-H ₂ O)	(dB(A))	(g)	
ME70151V1-0000-A99	●	12	113	1.36	3300	27.0	0.11	31.5	41.0	1
ME70151V2-0000-A99	●	12	74	0.89	2800	23.0	0.09	26.5	41.0	2
ME70151V3-0000-A99	●	12	47	0.57	2300	19.0	0.07	21.5	41.0	3

■ Function R Type : F99 / F Type : G99

■ Air Flow-Static Pressure Characteristics

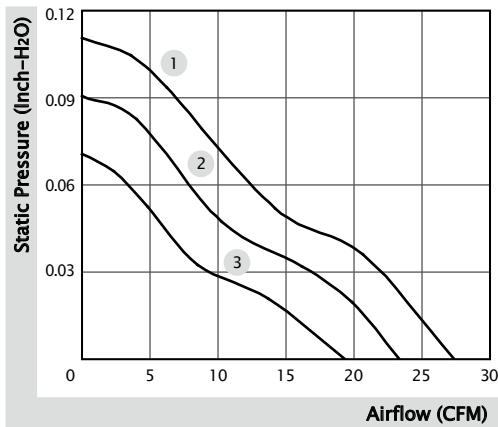

■ External Dimensions(mm)

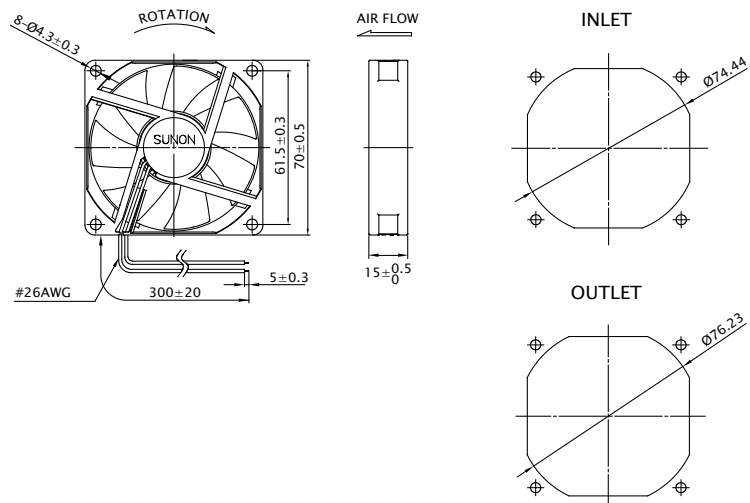

* All model could be customized. Please contact with Sunon Sales.

* Specifications are subject to change without notice. Please Visit SUNON website at www.sunon.com for update information.

■ RD / FG Output Signal

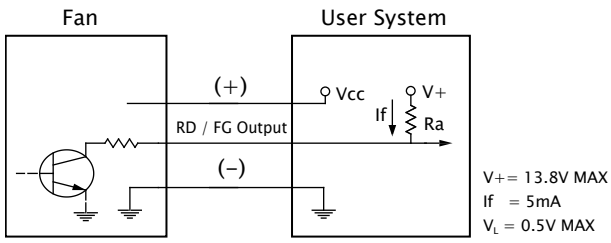

[RD Signal]

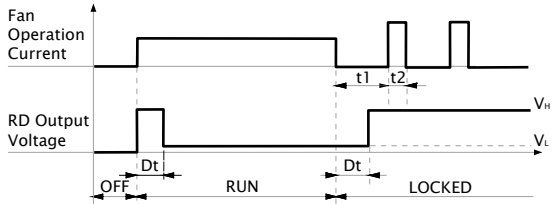

[FG Signal]

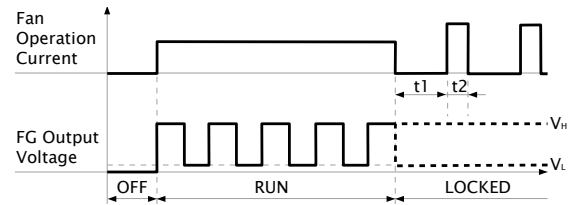
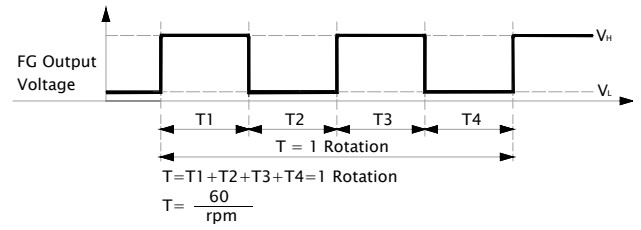

70x70x20 mm

23.5~29.0 CFM



■ Specification

	Bearing	Rated Voltage	Power Current	Power Consumption	Speed	Airflow	Static Pressure	Noise	Weight	Curve
	● VAPO	(VDC)	(mA)	(WATTS)	(RPM)	(CFM)	(inch-H ₂ O)	(dB(A))	(g)	
ME70201V1-0000-A99	●	12	130	1.56	3200	29.0	0.14	33.0	60.0	1
ME70201V2-0000-A99	●	12	99	1.19	2900	27.0	0.12	30.0	60.0	2
ME70201V3-0000-A99	●	12	77	0.93	2600	23.5	0.09	26.0	60.0	3
ME70202V1-0000-A99	●	24	66	1.59	3200	29.0	0.14	33.0	60.0	1
ME70202V2-0000-A99	●	24	55	1.32	2900	27.0	0.12	30.0	60.0	2
ME70202V3-0000-A99	●	24	44	1.06	2600	23.5	0.09	26.0	60.0	3

■ Function R Type : F99 / F Type : G99

■ Air Flow-Static Pressure Characteristics

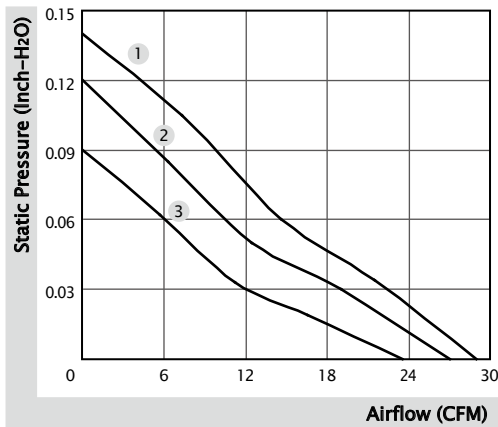

■ External Dimensions(mm)

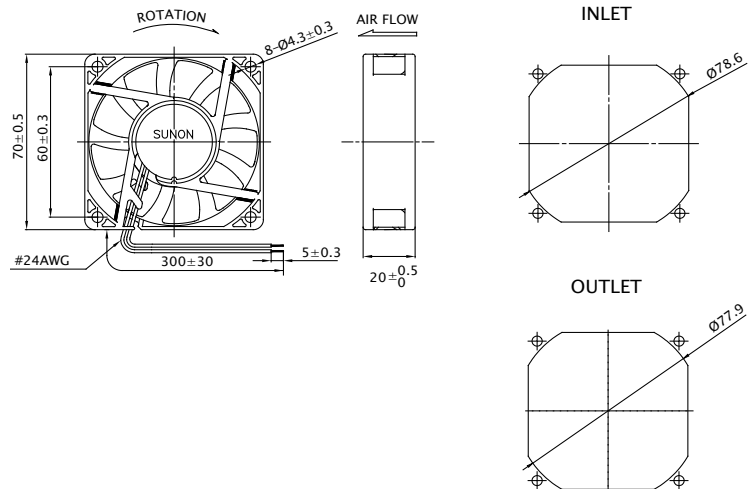

※ All model could be customized. Please contact with Sunon Sales.

※ Specifications are subject to change without notice. Please Visit SUNON website at www.sunon.com for update information.

■ RD / FG Output Signal

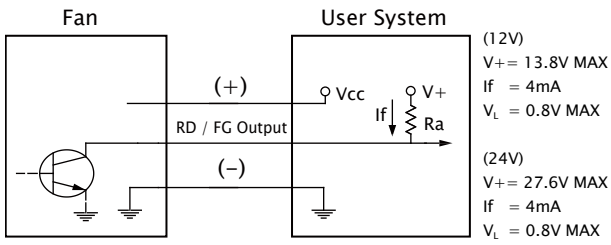

[RD Signal]

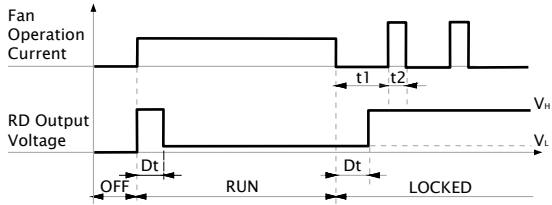

[FG Signal]

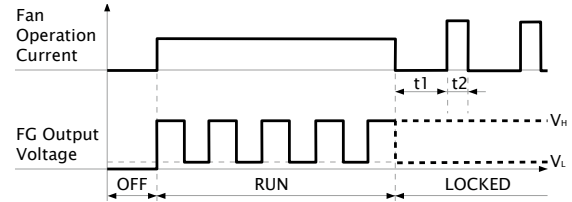
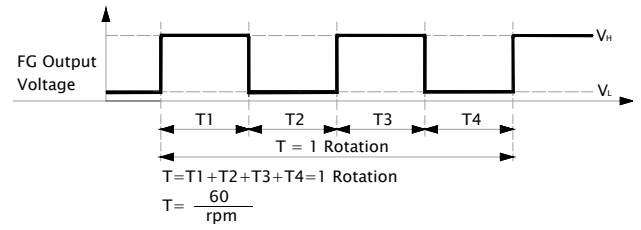

70x70x25 mm

40.0~49.0 CFM



■ Specification

	Bearing	Rated Voltage	Power Current	Power Consumption	Speed	Airflow	Static Pressure	Noise	Weight	Curve
	● VAPO	(VDC)	(mA)	(WATTS)	(RPM)	(CFM)	(inch-H ₂ O)	(dB(A))	(g)	
PMD2407PTV1-A GN	●	24	200	4.8	5100	49.0	0.36	44.0	90.0	1
PMD2407PTV2-A GN	●	24	160	3.8	4700	45.0	0.31	42.0	90.0	2
PMD2407PTV3-A GN	⊙	24	130	3.1	4200	40.0	0.25	38.0	90.0	3

■ Function R Type : (2).R.GN / F Type : (2).F.GN

■ Air Flow-Static Pressure Characteristics

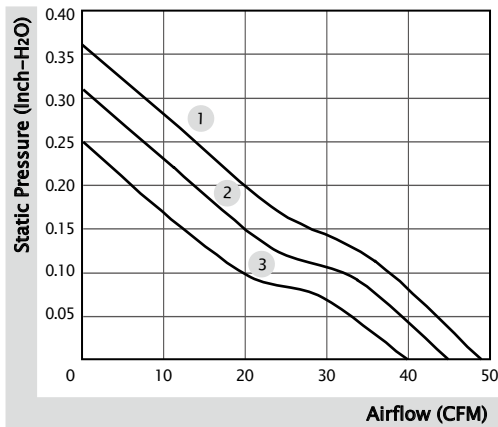

■ External Dimensions(mm)

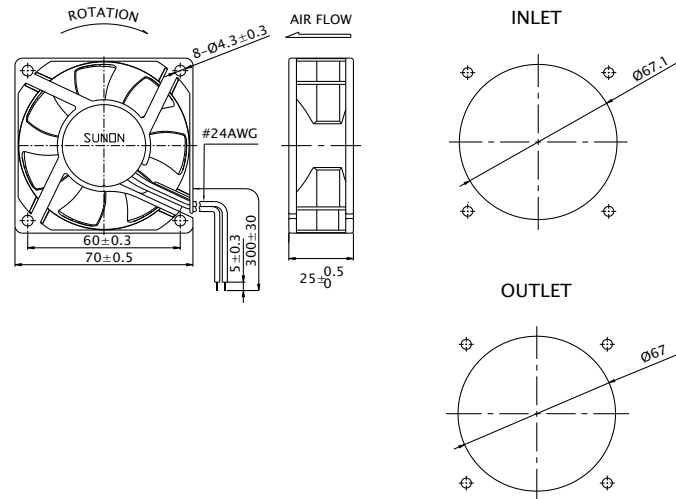

* All model could be customized. Please contact with Sunon Sales.

* Specifications are subject to change without notice. Please Visit SUNON website at www.sunon.com for update information.

■ RD / FG Output Signal

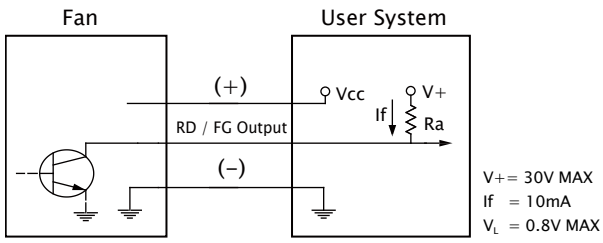

[RD Signal]

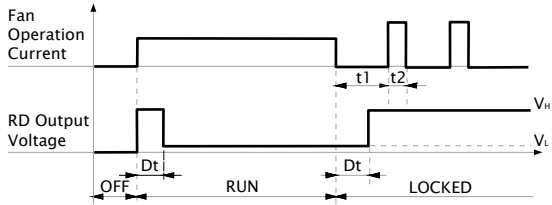

[FG Signal]

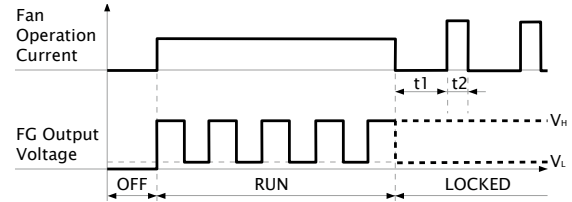
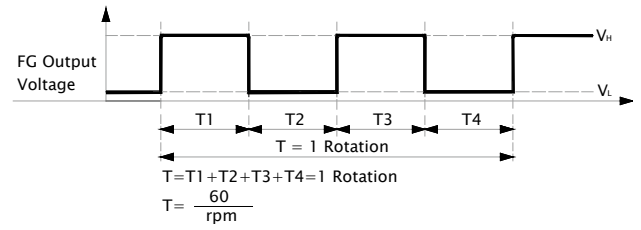

80x80x15 mm

30.0~37.0 CFM



■ Specification

	Bearing	Rated Voltage	Power Current	Power Consumption	Speed	Airflow	Static Pressure	Noise	Weight	Curve
	● VAPO	(VDC)	(mA)	(WATTS)	(RPM)	(CFM)	(inch-H ₂ O)	(dB(A))	(g)	
ME80151V1-0000-A99	●	12	163	1.96	3000	37.0	0.14	34.7	68.0	1
ME80151V2-0000-A99	●	12	129	1.55	2700	33.6	0.11	32.0	68.0	2
ME80151V3-0000-A99	●	12	90	1.08	2400	30.0	0.09	30.8	68.0	3
ME80152V1-0000-A99	●	24	92	2.21	3000	37.0	0.14	34.7	68.0	1
ME80152V2-0000-A99	●	24	65	1.56	2700	33.6	0.11	32.0	68.0	2
ME80152V3-0000-A99	●	24	56	1.35	2400	30.0	0.09	30.8	68.0	3
Model	○ 2BALL Sleeve	(VDC)	(mA)	(WATTS)	(RPM)	(CFM)	(inch-H ₂ O)	(dB(A))	(g)	
EE80151S1-0000-A99	○	12	163	1.96	3000	37.0	0.14	34.7	68.0	1
EE80151S2-0000-999	○	12	134	1.61	2700	33.6	0.11	32.0	68.0	2
EE80151S3-0000-999	○	12	100	1.20	2400	30.0	0.09	30.8	68.0	3

- Function (ME Series) R Type : F99 / F Type : G99
- (EE Series, Speed 1) R Type : F99 / F Type : G99
- (EE Series, Speed 2,3) F Type : C99

■ Air Flow-Static Pressure Characteristics

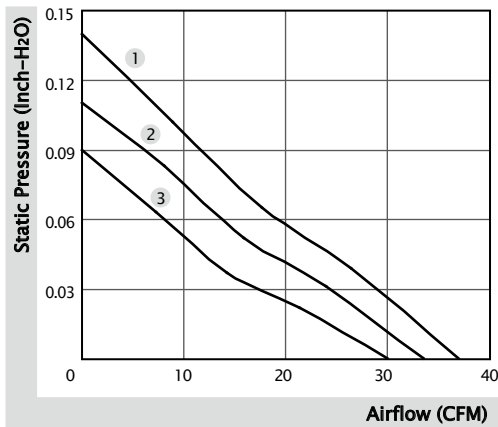

■ External Dimensions(mm)

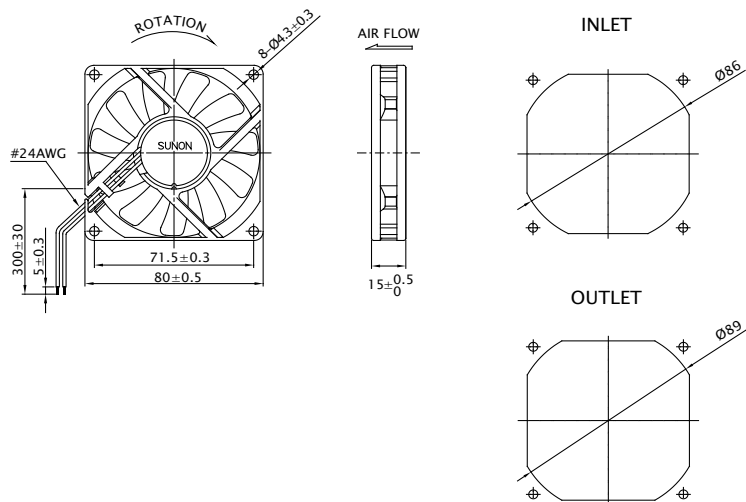

※ All model could be customized. Please contact with Sunon Sales.
 ※ Specifications are subject to change without notice. Please Visit SUNON website at www.sunon.com for update information.

■ RD / FG Output Signal

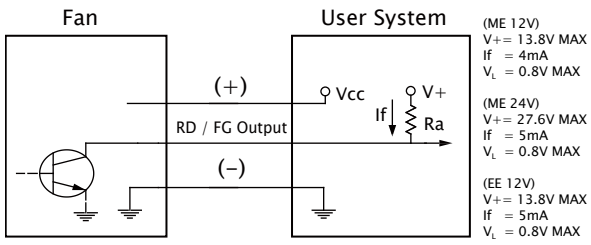

[RD Signal]

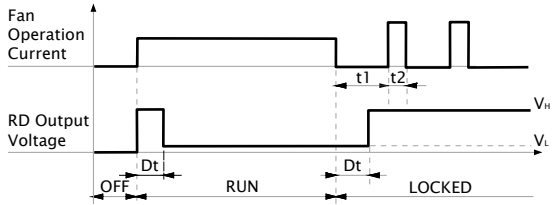

[FG Signal]

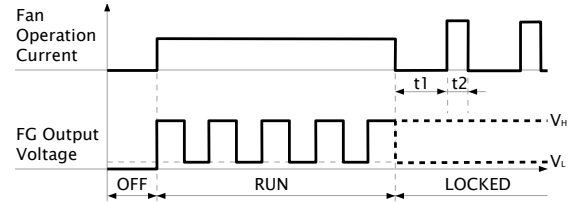
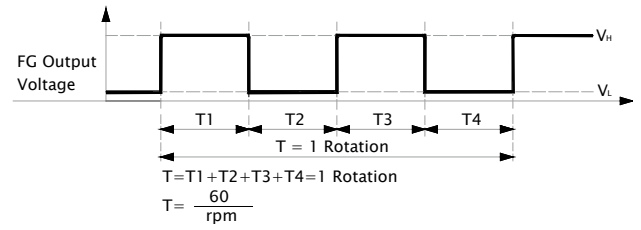

80x80x20 mm

29.0~36.0 CFM



■ Specification

	Bearing	Rated Voltage	Power Current	Power Consumption	Speed	Airflow	Static Pressure	Noise	Weight	Curve
	● VAPO	(VDC)	(mA)	(WATTS)	(RPM)	(CFM)	(inch-H ₂ O)	(dB(A))	(g)	
ME80201V1-0000-A99	●	12	130	1.56	3300	36.0	0.18	38.0	66.0	1
ME80201V2-0000-A99	●	12	95	1.14	3000	33.0	0.16	35.0	66.0	2
ME80201V3-0000-A99	●	12	74	0.89	2600	29.0	0.12	30.0	66.0	3
ME80202V1-0000-A99	●	24	64	1.54	3300	36.0	0.18	38.0	66.0	1
ME80202V2-0000-A99	●	24	51	1.23	3000	33.0	0.16	35.0	66.0	2
ME80202V3-0000-A99	●	24	42	1.01	2600	29.0	0.12	30.0	66.0	3

■ Function R Type : F99 / F Type : G99

■ Air Flow-Static Pressure Characteristics

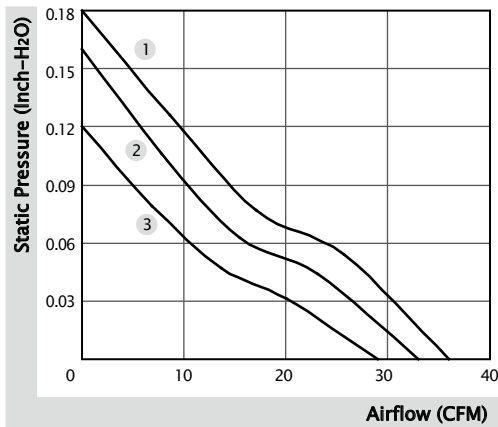

■ External Dimensions(mm)

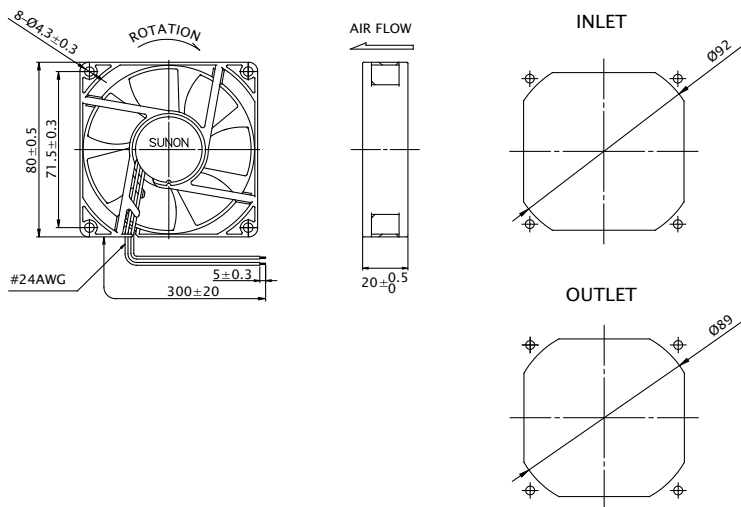

※ All model could be customized. Please contact with Sunon Sales.

※ Specifications are subject to change without notice. Please Visit SUNON website at www.sunon.com for update information.

■ RD / FG Output Signal

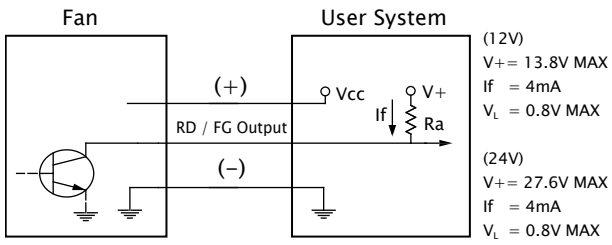

[RD Signal]

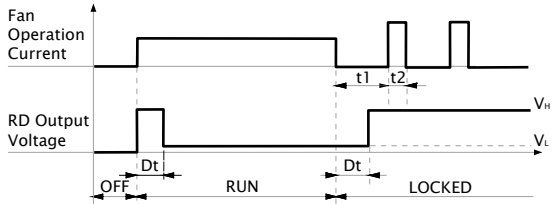

[FG Signal]

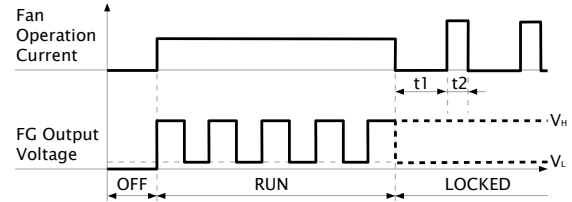
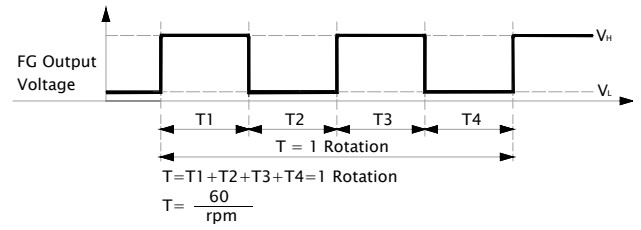

80x80x25 mm

53.0~60.0 CFM



■ Specification

	Bearing	Rated Voltage	Power Current	Power Consumption	Speed	Airflow	Static Pressure	Noise	Weight	Curve
	● VAPO	(VDC)	(mA)	(WATTS)	(RPM)	(CFM)	(inch-H ₂ O)	(dB(A))	(g)	
PF80251V1-10000-A99	●	12	310	3.72	4800	60.0	0.41	44.7	91.0	1
PF80251V2-10000-A99	●	12	240	2.88	4500	57.0	0.35	43.1	91.0	2
PF80251V3-10000-A99	●	12	200	2.40	4200	53.0	0.30	41.5	91.0	3
PF80252V1-10000-A99	●	24	180	4.32	4800	60.0	0.41	44.7	91.0	1
PF80252V2-10000-A99	●	24	126	3.03	4500	57.0	0.35	43.1	91.0	2
PF80252V3-10000-A99	●	24	110	2.64	4200	53.0	0.30	41.5	91.0	3

■ Function R Type : F99 / F Type : G99 / PWM : H99, Q99, S99

■ Air Flow-Static Pressure Characteristics

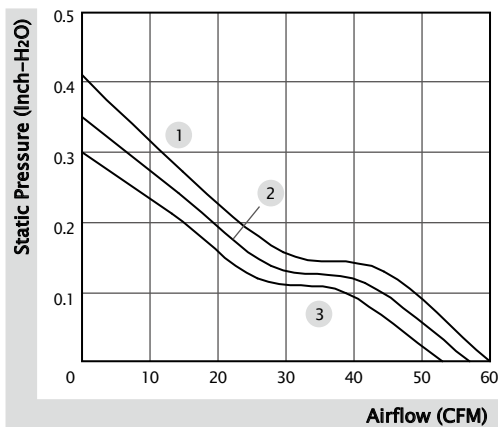

■ External Dimensions(mm)

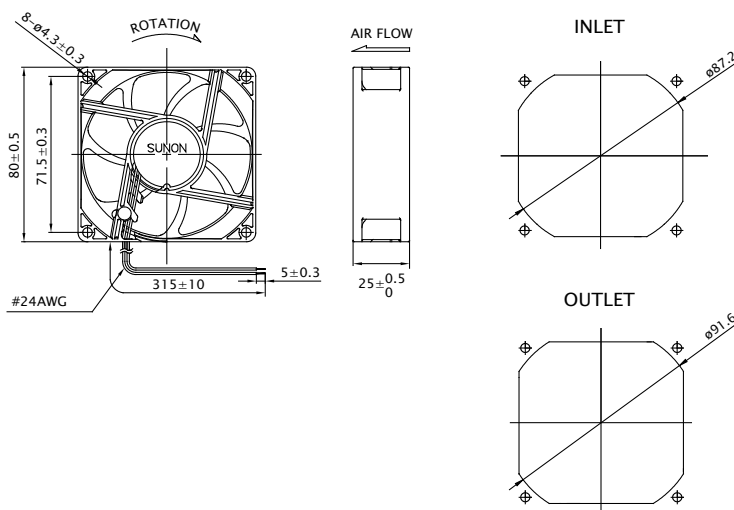

※ All model could be customized. Please contact with Sunon Sales.

※ Specifications are subject to change without notice. Please Visit SUNON website at www.sunon.com for update information.

■ RD / FG Output Signal

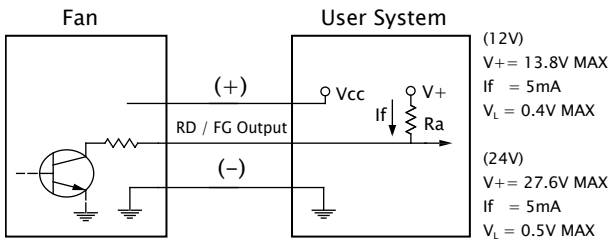

[RD Signal]

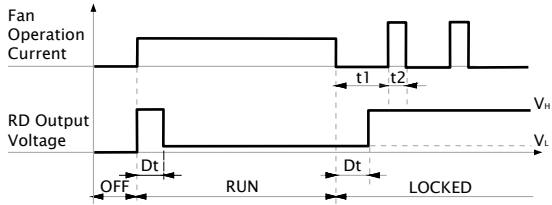

[FG Signal]

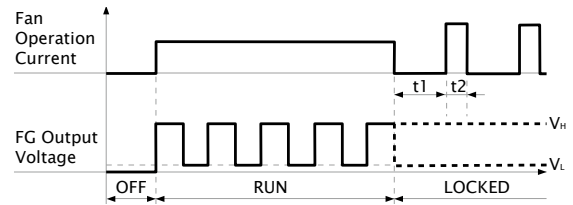
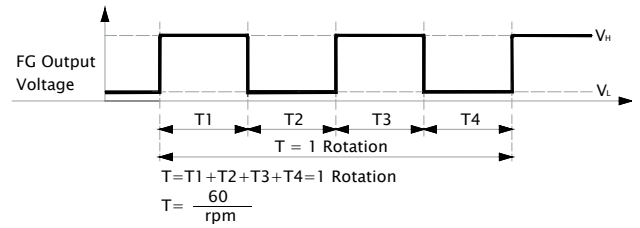

■ PWM Input Signal

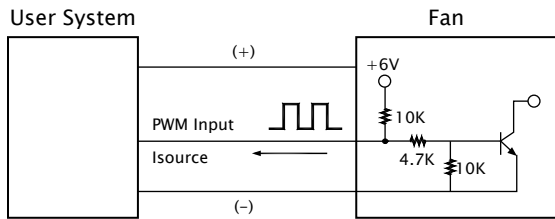

PWM FREQUENCY: 25KHZ
 Isource=0.5mA at PWM Input Voltage 0V
 The speed is default to be maximum if PWM input pin is unconnected.

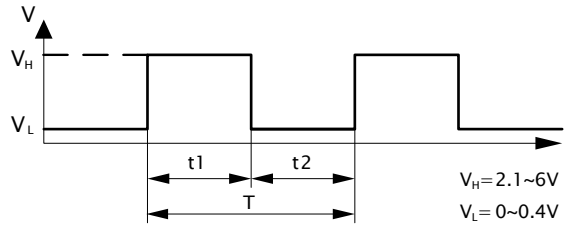

1. Period : $T = \frac{1}{f_{\text{PWM}}} = t_1 + t_2 (\text{sec})$

2. Duty Cycle (D.C.) : $\frac{t_1}{t_1 + t_2} \times 100 = \frac{t_1}{T} \times 100(\%)$

■ PWM Curve

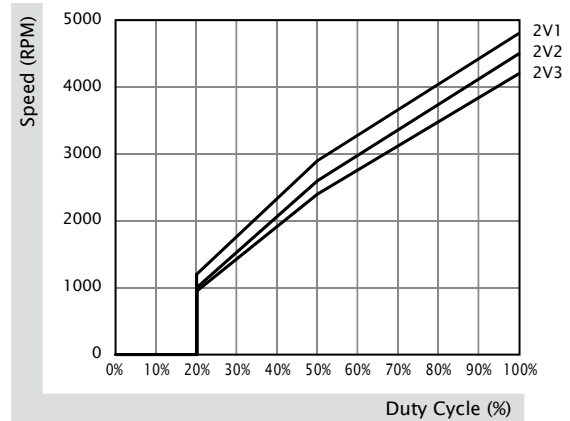
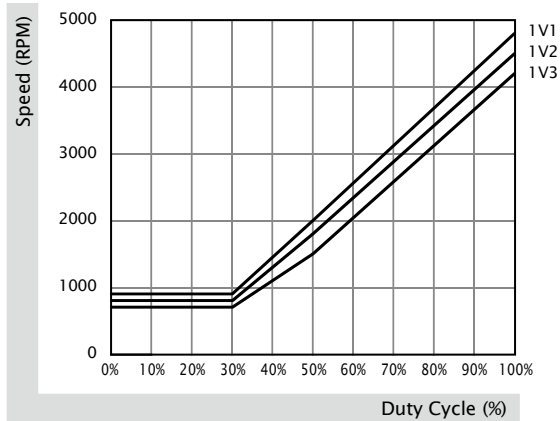

80x80x25 mm

53.0~60.0 CFM



■ Specification

Model	Bearing	Rated Voltage	Power Current	Power Consumption	Speed	Airflow	Static Pressure	Noise	Weight	Curve
	2BALL Sleeve	(VDC)	(mA)	(WATTS)	(RPM)	(CFM)	(inch-H ₂ O)	(dB(A))	(g)	
PF80251B1-10000-A99	☉	12	295	3.54	4800	60.0	0.41	45.5	91.0	1
PF80251B2-10000-A99	☉	12	255	3.06	4500	57.0	0.35	44.0	91.0	2
PF80251B3-10000-A99	☉	12	195	2.34	4200	53.0	0.30	42.5	91.0	3
PF80252B1-10000-A99	☉	24	155	3.72	4800	60.0	0.41	45.5	91.0	1
PF80252B2-10000-A99	☉	24	135	3.24	4500	57.0	0.35	44.0	91.0	2
PF80252B3-10000-A99	☉	24	100	2.40	4200	53.0	0.30	42.5	91.0	3

■ Function R Type : F99 / F Type : G99 / PWM : H99, Q99, S99

■ Air Flow-Static Pressure Characteristics

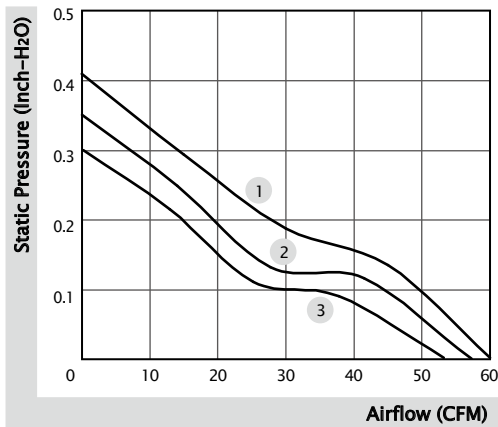

■ External Dimensions(mm)

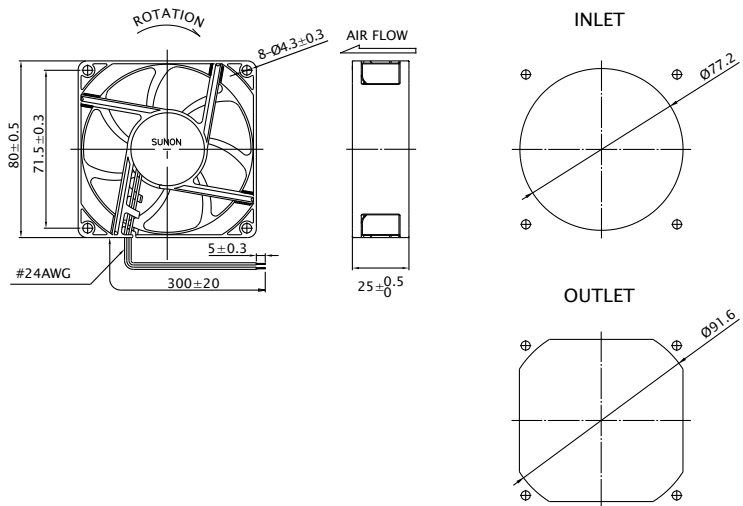

※ All model could be customized. Please contact with Sunon Sales.

※ Specifications are subject to change without notice. Please Visit SUNON website at www.sunon.com for update information.

■ RD / FG Output Signal

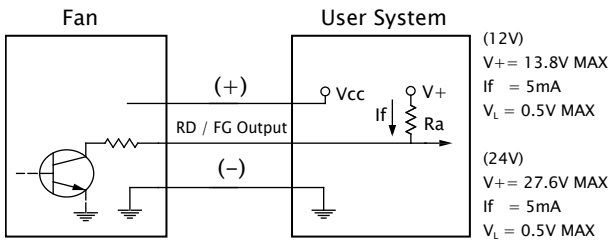

[RD Signal]

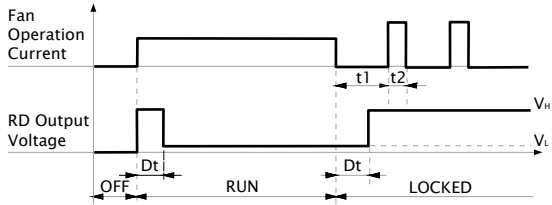

[FG Signal]

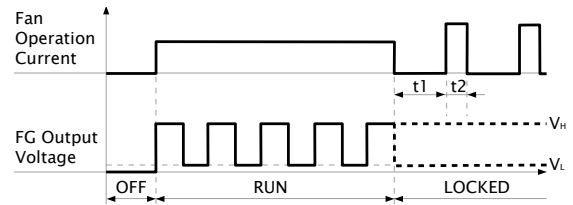
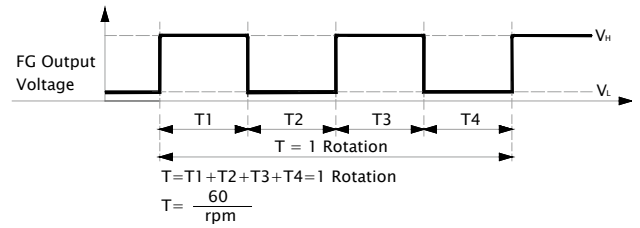

■ PWM Input Signal

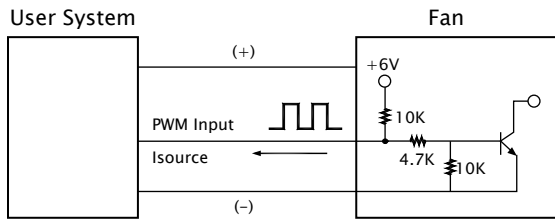

PWM FREQUENCY: 25KHZ
 Isource=0.6mA at PWM Input Voltage 0V
 The speed is default to be maximum if PWM input pin is unconnected.

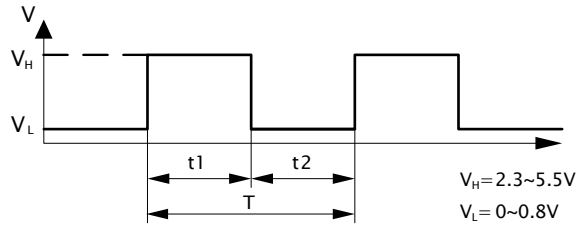

1. Period : $T = \frac{1}{f_{\text{PWM}}} = t_1 + t_2(\text{sec})$

2. Duty Cycle (D.C.) : $\frac{t_1}{t_1 + t_2} \times 100 = \frac{t_1}{T} \times 100(\%)$

■ PWM Curve

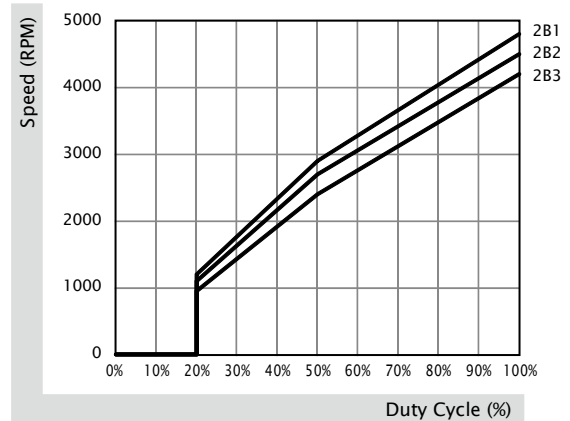
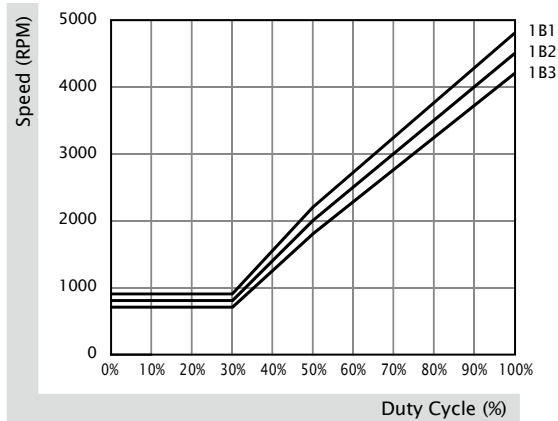

80x80x25 mm

33.0~41.0 CFM



■ Specification

	Bearing	Rated Voltage	Power Current	Power Consumption	Speed	Airflow	Static Pressure	Noise	Weight	Curve
	● VAPO	(VDC)	(mA)	(WATTS)	(RPM)	(CFM)	(inch-H ₂ O)	(dB(A))	(g)	
MF80251V1-10000-A99	●	12	120	1.44	3200	41.0	0.18	33.0	75.0	1
MF80251V2-10000-A99	●	12	92	1.11	2900	37.0	0.15	30.0	75.0	2
MF80251V3-10000-A99	●	12	65	0.78	2600	33.0	0.11	28.0	75.0	3
MF80252V1-10000-A99	●	24	65	1.56	3200	41.0	0.18	33.0	75.0	1
MF80252V2-10000-A99	●	24	50	1.20	2900	37.0	0.15	30.0	75.0	2
MF80252V3-10000-A99	●	24	40	0.96	2600	33.0	0.11	28.0	75.0	3
Model	○ 2BALL Sleeve	(VDC)	(mA)	(WATTS)	(RPM)	(CFM)	(inch-H ₂ O)	(dB(A))	(g)	
EF80251S1-10000-A99	○	12	120	1.44	3200	41.0	0.18	33.0	75.0	1
EF80251S2-10000-A99	○	12	95	1.14	2900	37.0	0.15	30.0	75.0	2
EF80251S3-10000-A99	○	12	70	0.84	2600	33.0	0.11	28.0	75.0	3
EF80252S1-10000-A99	○	24	55	1.32	3200	41.0	0.18	33.0	75.0	1
EF80252S2-10000-A99	○	24	42	1.01	2900	37.0	0.15	30.0	75.0	2

- Function (MF Series) R Type : F99 / F Type : G99
- (EF Series, Speed 1) R Type : F99 / F Type : G99
- (EF Series, Speed 2,3) F Type : G99

■ Air Flow-Static Pressure Characteristics

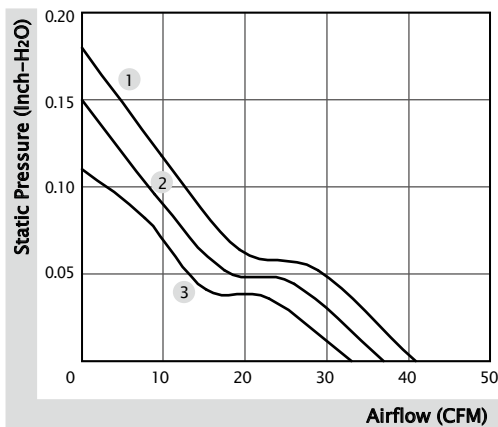

■ External Dimensions(mm)

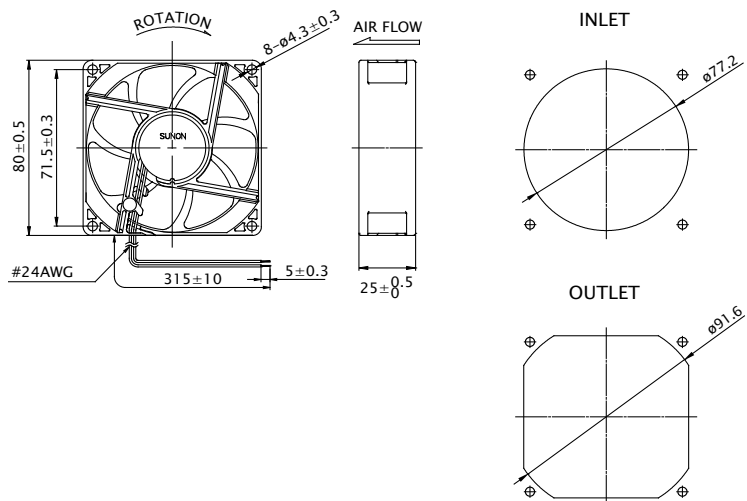

※ All model could be customized. Please contact with Sunon Sales.
 ※ Specifications are subject to change without notice. Please Visit SUNON website at www.sunon.com for update information.

■ RD / FG Output Signal

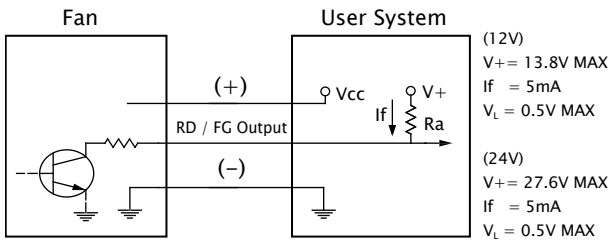

[RD Signal]

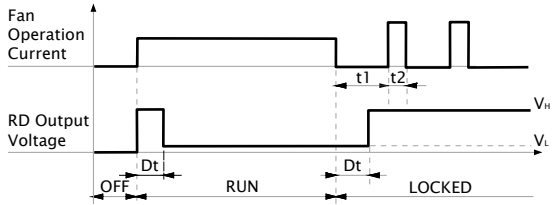

[FG Signal]

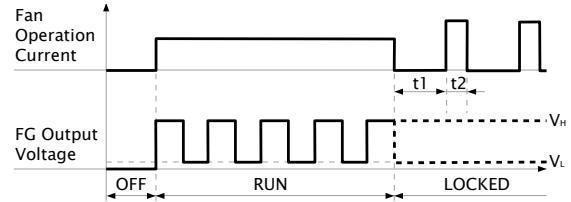
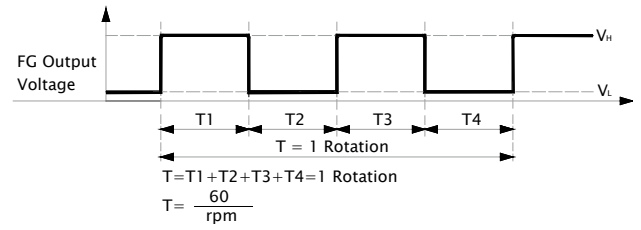

80x80x25 mm

33.0~45.0 CFM



■ Specification

Model	Bearing	Rated Voltage	Power Current	Power Consumption	Speed	Airflow	Static Pressure	Noise	Weight	Curve
	2BALL Sleeve	(VDC)	(mA)	(WATTS)	(RPM)	(CFM)	(inch-H ₂ O)	(dB(A))	(g)	
EE80251BX-0000-A99	☉	12	150	1.80	3600	45.0	0.23	38.0	89.0	1
EF80251B1-10000-A99	☉	12	125	1.50	3200	41.0	0.18	33.0	75.0	2
EF80251B2-10000-A99	☉	12	90	1.08	2900	37.0	0.15	30.0	75.0	3
EF80251B3-10000-A99	☉	12	65	0.78	2600	33.0	0.11	28.0	75.0	4
EE80252BX-0000-A99	☉	24	80	1.90	3600	45.0	0.23	38.0	89.0	1
EF80252B1-10000-A99	☉	24	65	1.56	3200	41.0	0.18	33.0	75.0	2
EF80252B2-10000-A99	☉	24	48	1.16	2900	37.0	0.15	30.0	75.0	3
EF80252B3-10000-A99	☉	24	36	0.89	2600	33.0	0.11	28.0	75.0	4

■ Function R Type : F99 / F Type : G99

■ Air Flow-Static Pressure Characteristics

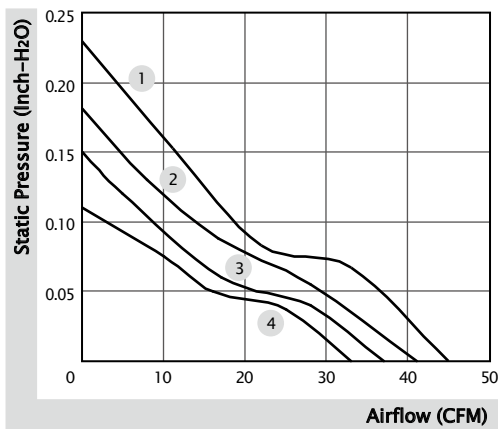

■ External Dimensions(mm)

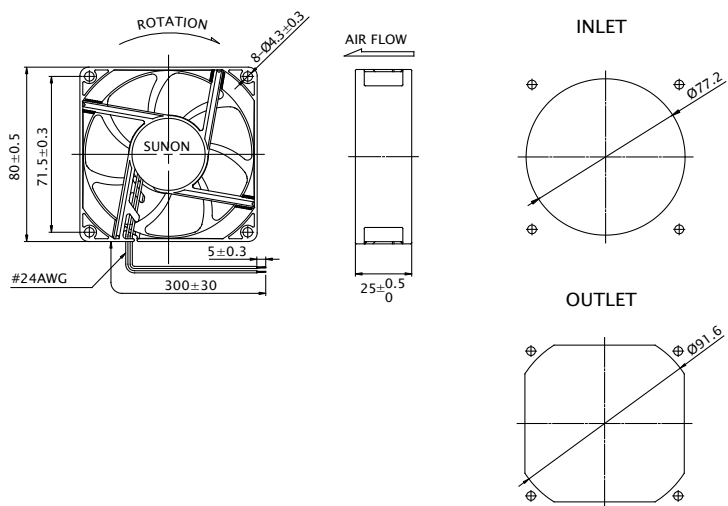

※ All model could be customized. Please contact with Sunon Sales.

※ Specifications are subject to change without notice. Please Visit SUNON website at www.sunon.com for update information.

■ RD / FG Output Signal

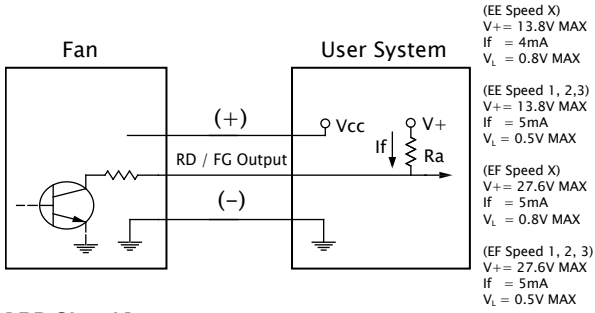

[RD Signal]

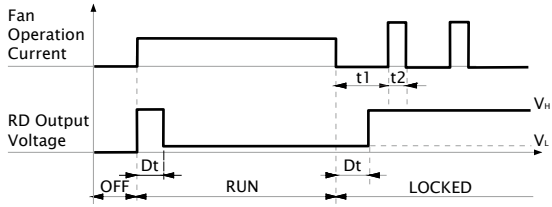

[FG Signal]

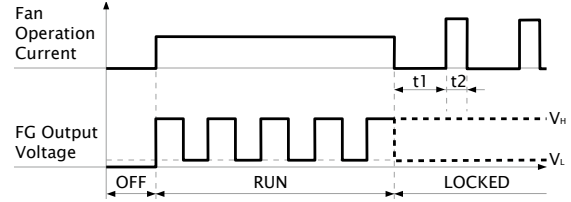
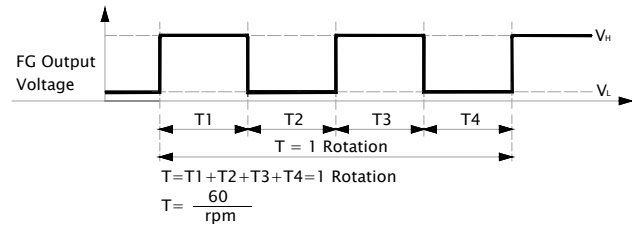

80x80x25 mm

23.9 CFM



■ Specification

	Bearing	Rated Voltage	Power Current	Power Consumption	Speed	Airflow	Static Pressure	Noise	Weight	Curve
	● VAPO	(VDC)	(mA)	(WATTS)	(RPM)	(CFM)	(inch-H ₂ O)	(dB(A))	(g)	
HA80251V4-10000-A99	●	12	40	0.48	2000	23.9	0.07	20.4	75.0	1

■ Function F Type : G99

■ Air Flow-Static Pressure Characteristics

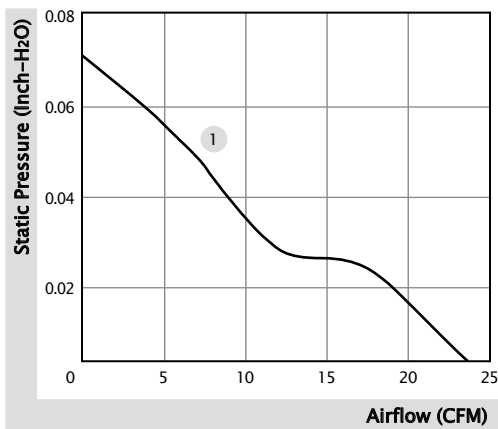

■ External Dimensions(mm)

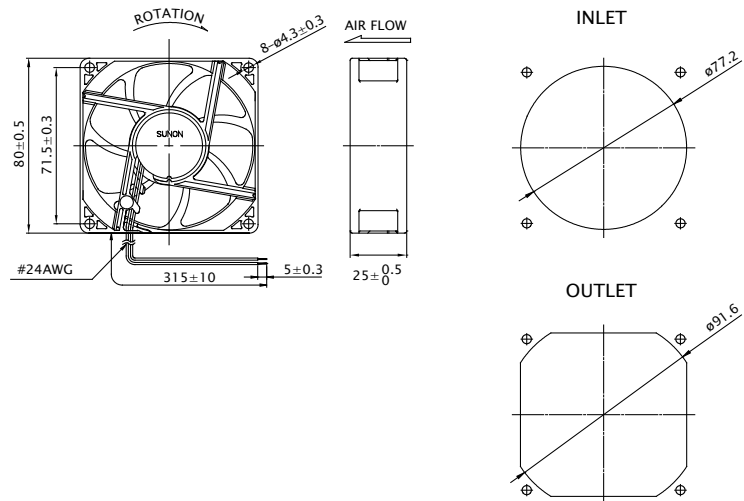

※ All model could be customized. Please contact with Sunon Sales.

※ Specifications are subject to change without notice. Please Visit SUNON website at www.sunon.com for update information.

■ RD / FG Output Signal

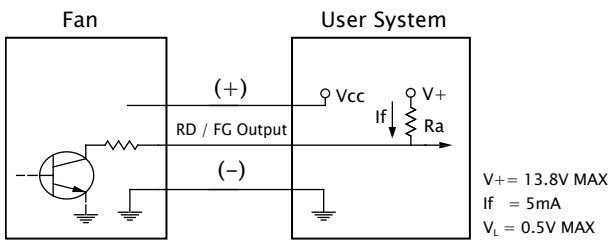

[FG Signal]

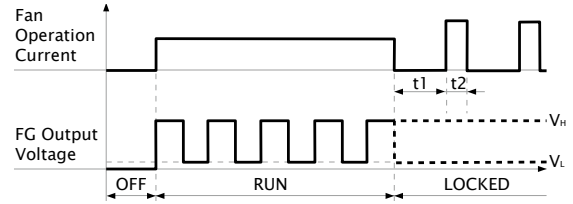
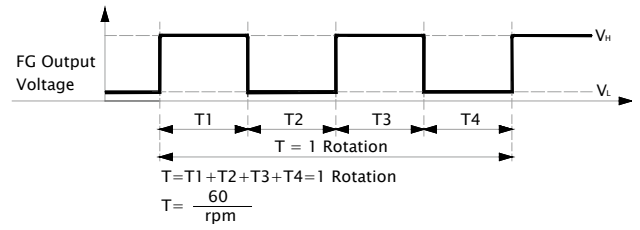

80x80x25 mm (IP68)

33.0~60.0 CFM



■ Specification

Model	Bearing	Rated Voltage	Power Current	Power Consumption	Speed	Airflow	Static Pressure	Noise	Weight	Curve
	2BALL Sleeve	(VDC)	(mA)	(WATTS)	(RPM)	(CFM)	(inch-H ₂ O)	(dB(A))	(g)	
GF80251B1-0000-AE9	☉	12	330	3.96	4800	60.0	0.41	47.5	105.0	1
GF80251B2-0000-AE9	☉	12	255	3.06	4500	57.0	0.35	46.0	105.0	2
GF80251B3-0000-AE9	☉	12	200	2.40	4200	53.0	0.30	44.5	105.0	3
GF80251B5-0000-AE9	☉	12	145	1.74	3200	41.0	0.18	33.0	87.0	4
GF80251B6-0000-AE9	☉	12	120	1.44	2900	37.0	0.15	30.0	87.0	5
GF80251B7-0000-AE9	☉	12	84	1.01	2600	33.0	0.11	28.0	87.0	6
GE80252B1-0000-AE9	☉	24	200	4.80	4800	60.0	0.41	47.5	105.0	1
GE80252B2-0000-AE9	☉	24	166	3.99	4500	57.0	0.35	46.0	105.0	2
GE80252B3-0000-AE9	☉	24	137	3.29	4200	53.0	0.30	44.5	105.0	3
GF80252B5-0000-AE9	☉	24	73	1.76	3200	41.0	0.18	33.0	87.0	4
GF80252B6-0000-AE9	☉	24	59	1.42	2900	37.0	0.15	30.0	87.0	5
GF80252B7-0000-AE9	☉	24	45	1.08	2600	33.0	0.11	28.0	87.0	6

■ Function (Speed 1, 2, 3) R Type : FE9 / F Type : GE9 / PWM : HE9, QE9, SE9
 (Speed 5, 6, 7) R Type : FE9 / F Type : GE9

■ Air Flow-Static Pressure Characteristics

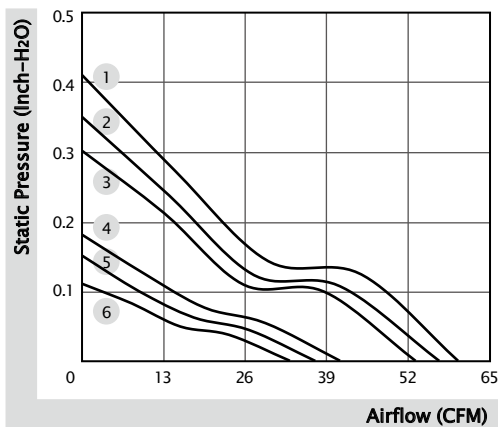

■ External Dimensions(mm)

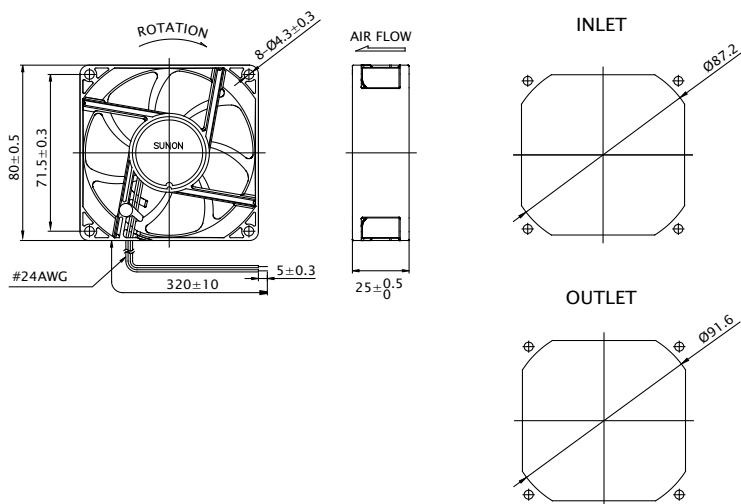

※ All model could be customized. Please contact with Sunon Sales.

※ Specifications are subject to change without notice. Please Visit SUNON website at www.sunon.com for update information.

■ RD / FG Output Signal

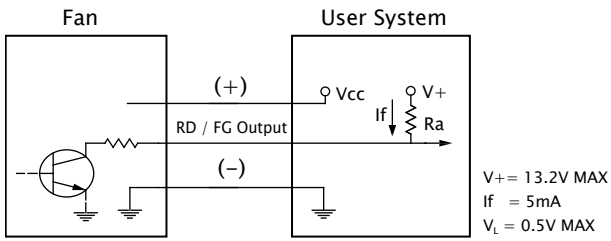

[RD Signal]

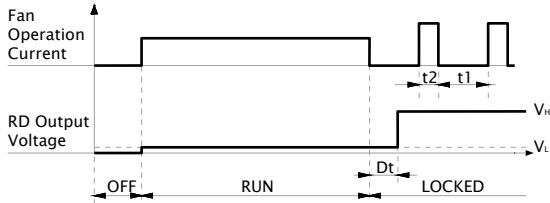

[FG Signal]

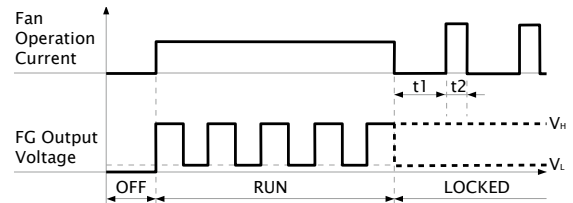
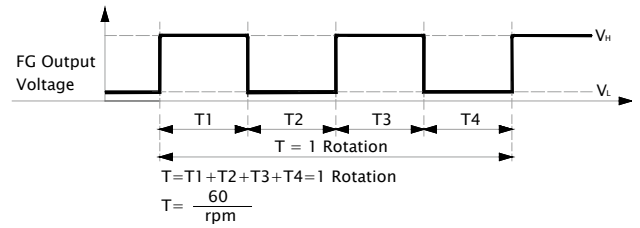

■ PWM Input Signal

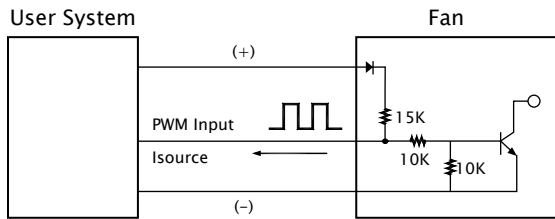

PWM FREQUENCY: 25KHZ
 Isource=0..8mA at PWM Input Voltage 0V
 The speed is default to be maximum if PWM input pin is unconnected.

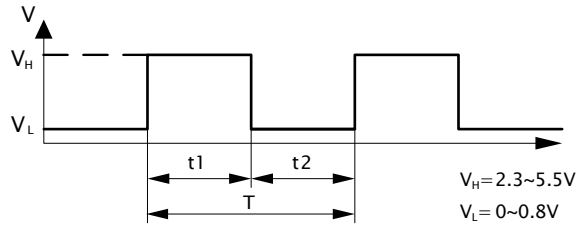

1. Period : $T = \frac{1}{f_{PWM}} = t1 + t2(\text{sec})$

2. Duty Cycle (D.C.) : $\frac{t1}{t1+t2} \times 100 = \frac{t1}{T} \times 100(\%)$

■ PWM Curve

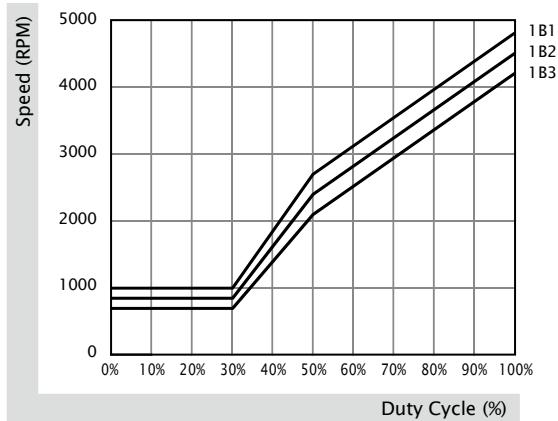

80x80x25 mm (GR487)

33.0~41.0 CFM



■ Specification

Model	Bearing	Rated Voltage	Power Current	Power Consumption	Speed	Airflow	Static Pressure	Noise	Weight	Curve
	2BALL Sleeve	(VDC)	(mA)	(WATTS)	(RPM)	(CFM)	(inch-H ₂ O)	(dB(A))	(g)	
GF80251B5-0000-AD9	☉	12	145	1.74	3200	41.0	0.18	33.0	87.0	1
GF80251B6-0000-AD9	☉	12	120	1.44	2900	37.0	0.15	30.0	87.0	2
GF80251B7-0000-AD9	☉	12	84	1.01	2600	33.0	0.11	28.0	87.0	3
GF80252B5-0000-AD9	☉	24	73	1.76	3200	41.0	0.18	33.0	87.0	1
GF80252B6-0000-AD9	☉	24	59	1.42	2900	37.0	0.15	30.0	87.0	2
GF80252B7-0000-AD9	☉	24	45	1.08	2600	33.0	0.11	28.0	87.0	3

■ Function R Type : FD9 / F Type : GD9

■ Air Flow-Static Pressure Characteristics

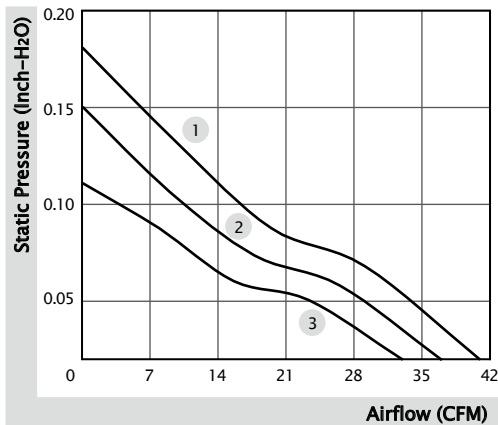

■ External Dimensions(mm)

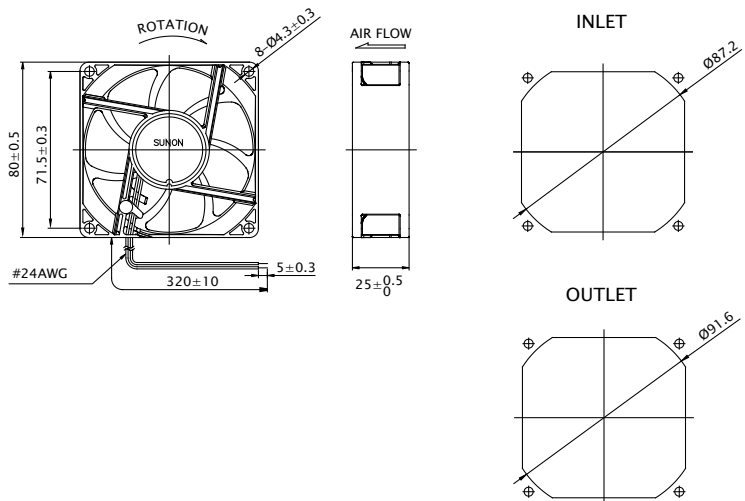

※ All model could be customized. Please contact with Sunon Sales.

※ Specifications are subject to change without notice. Please Visit SUNON website at www.sunon.com for update information.

■ RD / FG Output Signal

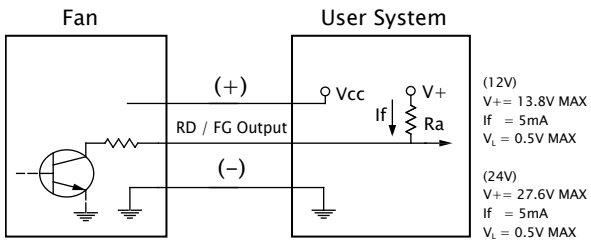

[RD Signal]

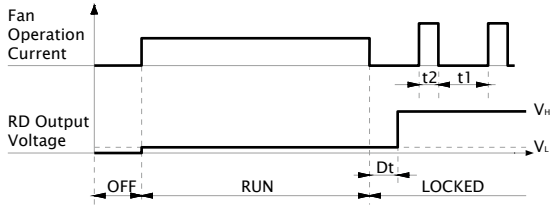

[FG Signal]

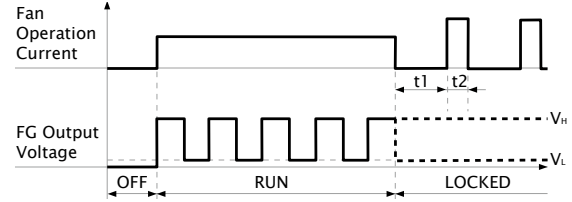
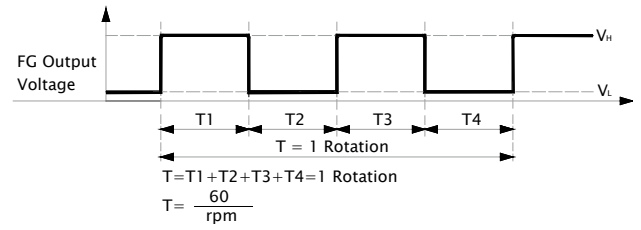

80x80x32 mm (IP68)

50.3~59.4 CFM



■ Specification

Model	Bearing	Rated Voltage	Power Current	Power Consumption	Speed	Airflow	Static Pressure	Noise	Weight	Curve
	2BALL Sleeve	(VDC)	(mA)	(WATTS)	(RPM)	(CFM)	(inch-H ₂ O)	(dB(A))	(g)	
GF80321B1-0000-AE9	☉	12	310	3.72	4800	59.4	0.36	45.2	109.0	1
GF80321B2-0000-AE9	☉	12	230	2.76	4500	55.9	0.32	43.1	109.0	2
GF80321B3-0000-AE9	☉	12	190	2.28	4100	50.3	0.27	41.1	109.0	3

■ Function R Type : FE9 / F Type : GE9 / PWM : HE9, QE9, SE9

■ Air Flow-Static Pressure Characteristics

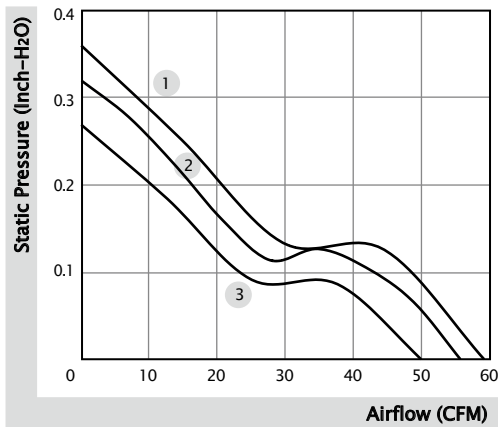

■ External Dimensions(mm)

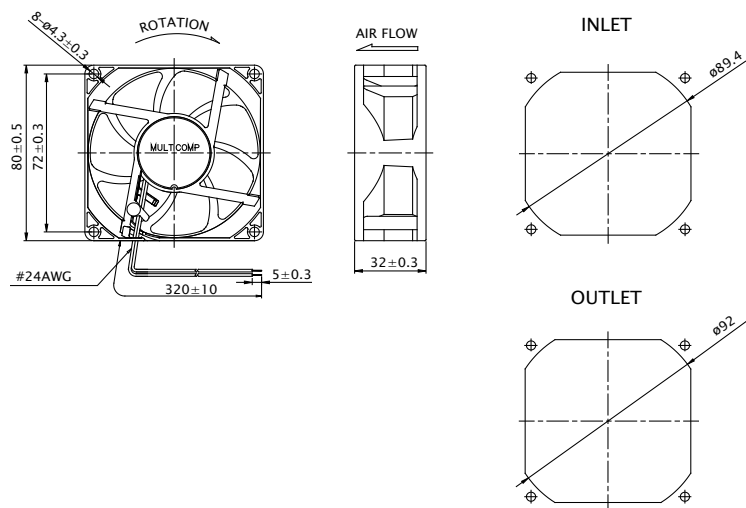

※ All model could be customized. Please contact with Sunon Sales.

※ Specifications are subject to change without notice. Please Visit SUNON website at www.sunon.com for update information.

■ RD / FG Output Signal

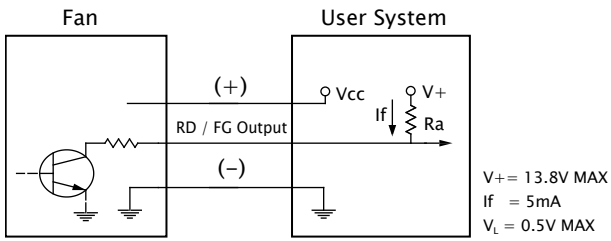

[RD Signal]

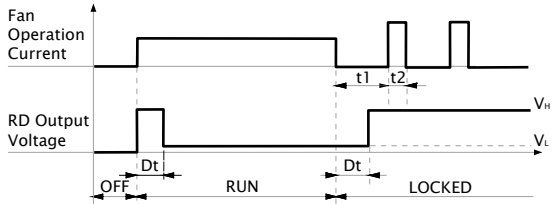

[FG Signal]

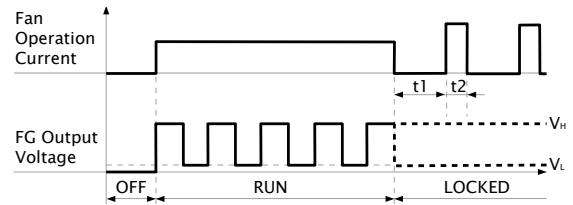
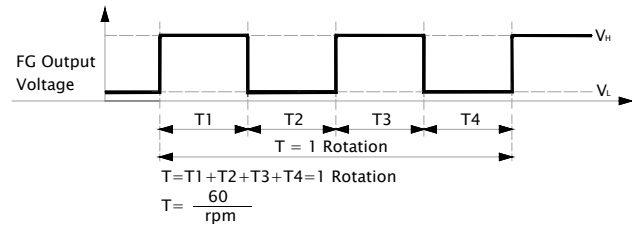

■ PWM Input Signal

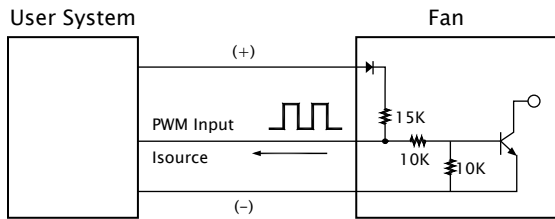

PWM FREQUENCY: 25KHZ
 Isource=0..8mA at PWM Input Voltage 0V
 The speed is default to be maximum if PWM input pin is unconnected.

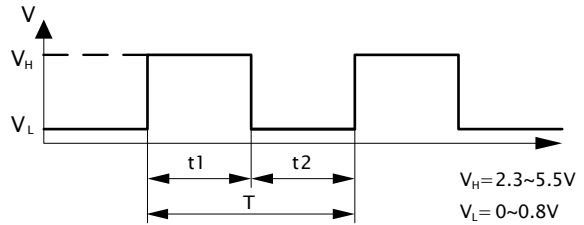

1. Period : $T = \frac{1}{f_{PWM}} = t1 + t2(\text{sec})$

2. Duty Cycle (D.C.) : $\frac{t1}{t1+t2} \times 100 = \frac{t1}{T} \times 100(\%)$

■ PWM Curve

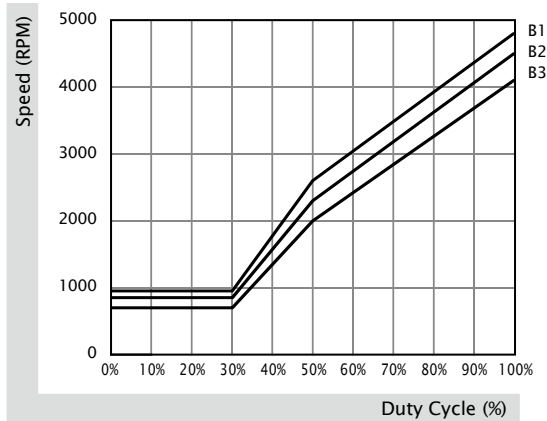

80x80x38 mm

113.9~141.9 CFM



■ Specification

Model	Bearing	Rated Voltage	Power Current	Power Consumption	Speed	Airflow	Static Pressure	Noise	Weight	Curve
	2BALL Sleeve	(VDC)	(mA)	(WATTS)	(RPM)	(CFM)	(inch-H ₂ O)	(dB(A))	(g)	
PF80381BX-0000-A99	☉	12	4000	48.00	14000	141.9	3.20	72.1	195.0	1
PF80381B1-0000-A99	☉	12	2000	24.00	11200	113.9	2.23	64.8	195.0	2

■ Function R Type : F99 / F Type : G99 / PWM : H99, Q99, S99

■ Air Flow-Static Pressure Characteristics

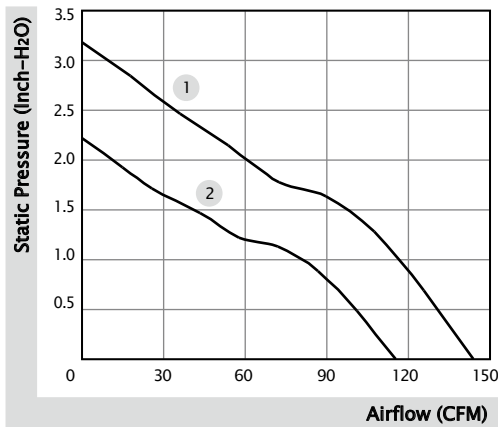

■ External Dimensions(mm)

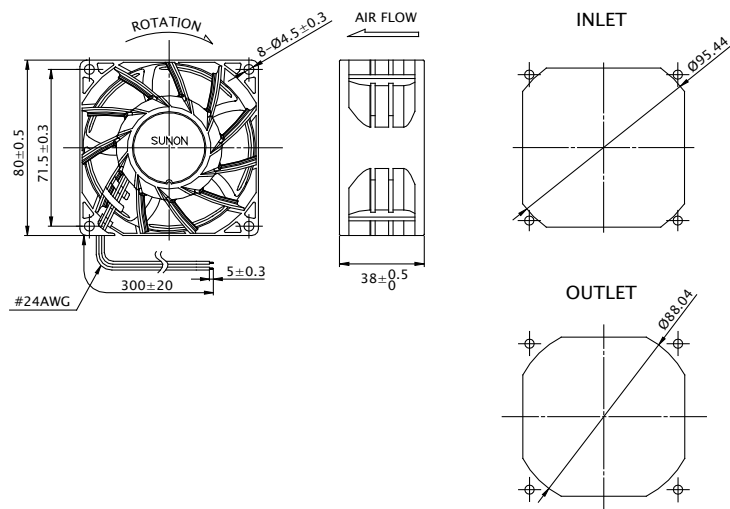

※ All model could be customized. Please contact with Sunon Sales.

※ Specifications are subject to change without notice. Please Visit SUNON website at www.sunon.com for update information.

■ RD / FG Output Signal

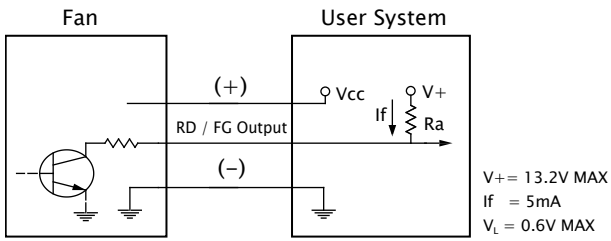

[RD Signal]

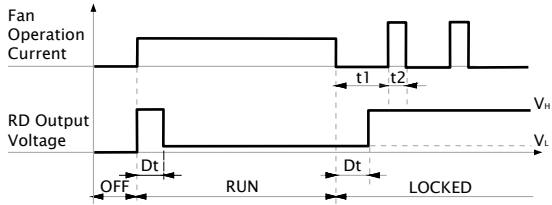

[FG Signal]

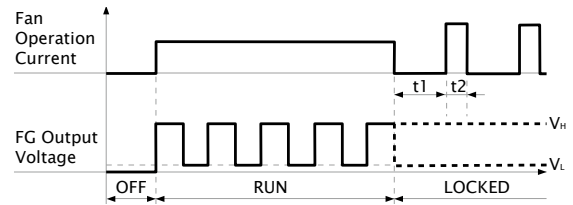
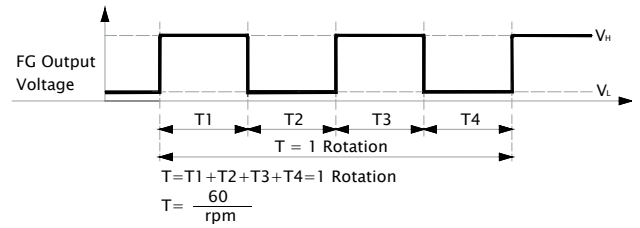

■ PWM Input Signal

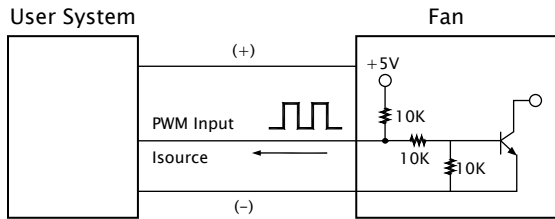

PWM FREQUENCY: 25KHZ
 Isource=0.5mA at PWM Input Voltage 0V
 The speed is default to be maximum if PWM input pin is unconnected.
 Min. start up duty cycle is 10%.

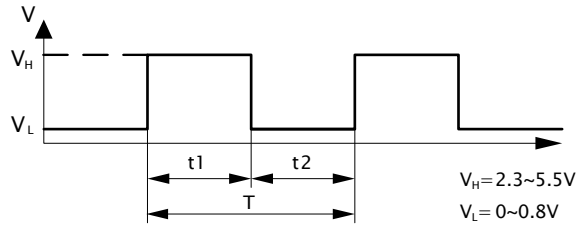

1. Period : $T = \frac{1}{f_{PWM}} = t1 + t2(\text{sec})$

2. Duty Cycle (D.C.) : $\frac{t1}{t1+t2} \times 100 = \frac{t1}{T} \times 100(\%)$

■ PWM Curve

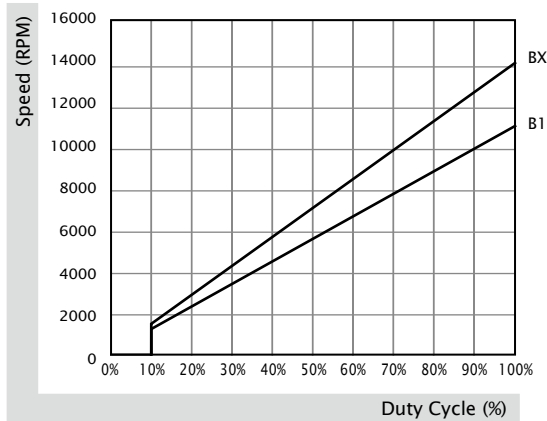

80x80x38 mm

105.8~134.3 CFM



■ Specification

Model	Bearing	Rated Voltage	Power Current	Power Consumption	Speed	Airflow	Static Pressure	Noise	Weight	Curve
	2BALL Sleeve	(VDC)	(mA)	(WATTS)	(RPM)	(CFM)	(inch-H ₂ O)	(dB(A))	(g)	
PF80384BX-0000-A99	☉	48	700	33.60	12900	134.3	3.35	67.5	204.0	1
PF80384B1-0000-A99	☉	48	380	18.24	10500	105.8	2.46	62.6	204.0	2

■ Function R Type : F99 / F Type : G99 / PWM : H99, Q99, S99

■ Air Flow-Static Pressure Characteristics

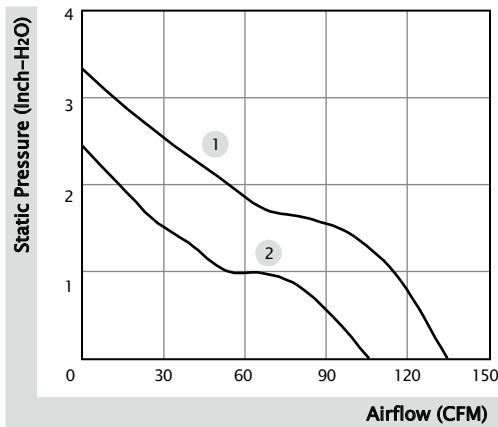

■ External Dimensions(mm)

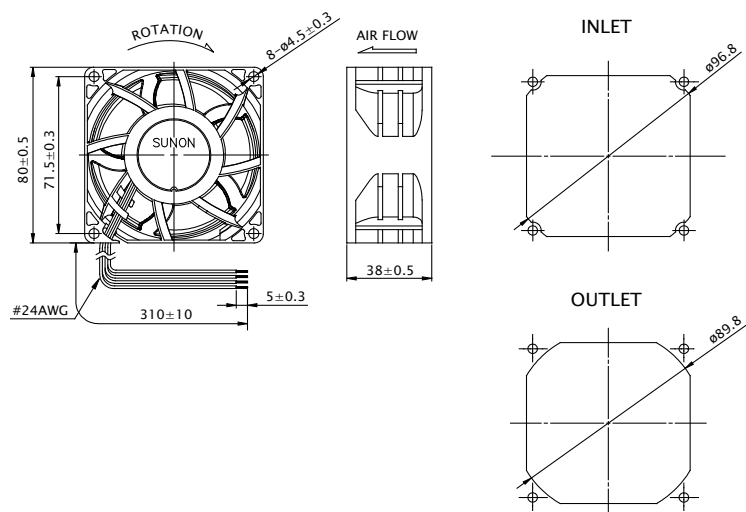

※ All model could be customized. Please contact with Sunon Sales.

※ Specifications are subject to change without notice. Please Visit SUNON website at www.sunon.com for update information.

■ RD / FG Output Signal

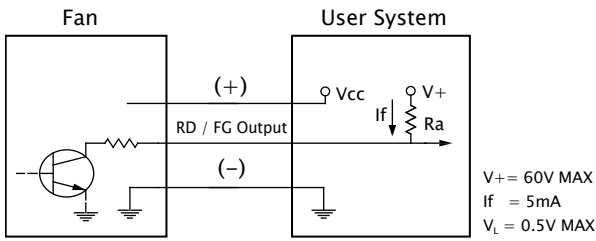

[RD Signal]

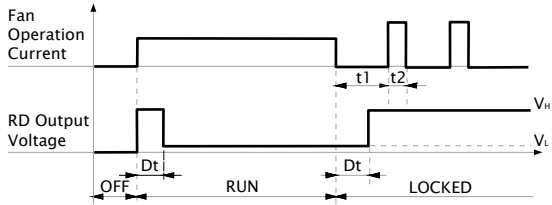

[FG Signal]

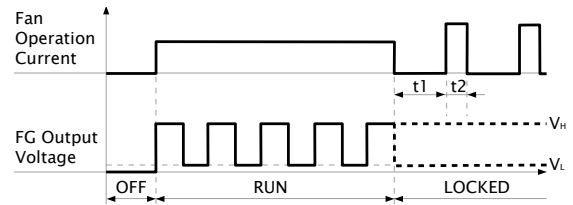
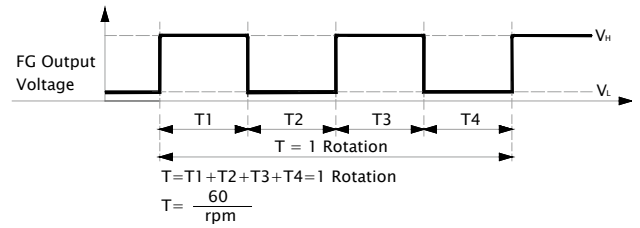

■ PWM Input Signal

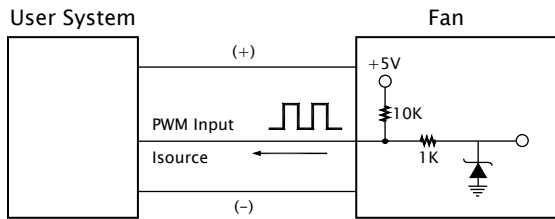

PWM FREQUENCY: 25KHZ
 $I_{source} = 0.5mA$ at PWM Input Voltage 0V
 The speed is default to be maximum if PWM input pin is unconnected.
 Min. start up duty cycle is 10%.

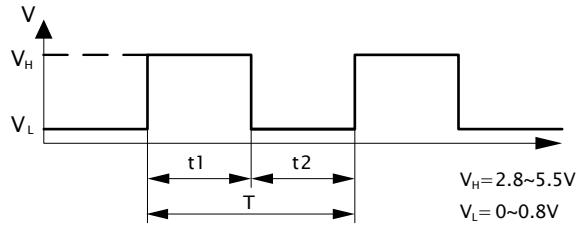

1. Period : $T = \frac{1}{f_{PWM}} = t_1 + t_2 (\text{sec})$

2. Duty Cycle (D.C.) : $\frac{t_1}{t_1 + t_2} \times 100 = \frac{t_1}{T} \times 100(\%)$

■ PWM Curve

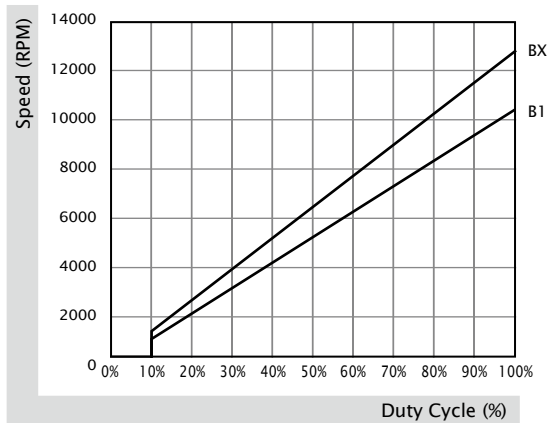

80x80x38 mm

59.5~84.1 CFM



■ Specification

Model	Bearing	Rated Voltage	Power Current	Power Consumption	Speed	Airflow	Static Pressure	Noise	Weight	Curve
	2BALL Sleeve	(VDC)	(mA)	(WATTS)	(RPM)	(CFM)	(inch-H ₂ O)	(dB(A))	(g)	
PMD1208PMB1-A (2).GN	☉	12	760	9.1	5700	84.1	0.74	55.2	175.0	1
PMD1208PMB2-A (2).GN	☉	12	530	6.4	4900	74.5	0.57	51.6	175.0	2
PMD1208PMB3-A (2).GN	☉	12	370	4.4	4200	59.5	0.43	47.3	175.0	3
PMD2408PMB1-A (2).GN	☉	24	400	9.6	5700	84.1	0.74	55.2	175.0	1
PMD2408PMB2-A (2).GN	☉	24	300	7.2	4900	74.5	0.57	51.6	175.0	2
PMD2408PMB3-A (2).GN	☉	24	200	4.8	4200	59.5	0.43	47.3	175.0	3

■ Function R Type : (2).R.GN / F Type : (2).F.GN

■ Air Flow-Static Pressure Characteristics

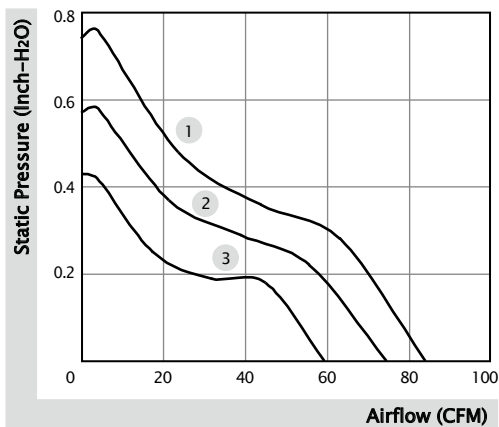

■ External Dimensions(mm)

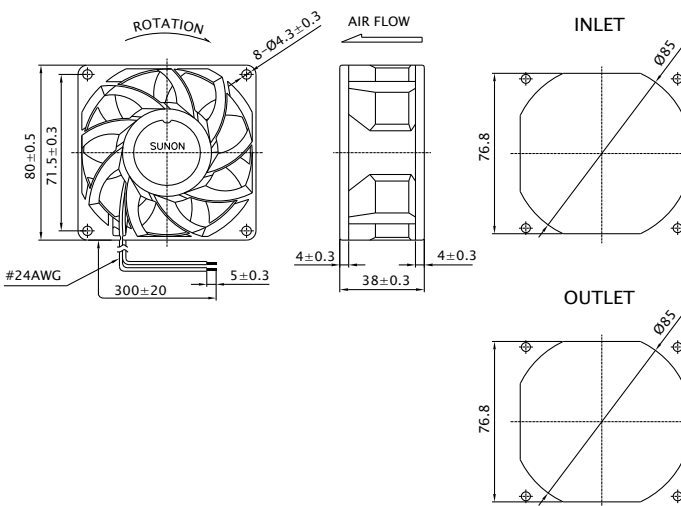

※ All model could be customized. Please contact with Sunon Sales.

※ Specifications are subject to change without notice. Please Visit SUNON website at www.sunon.com for update information.

■ RD / FG Output Signal

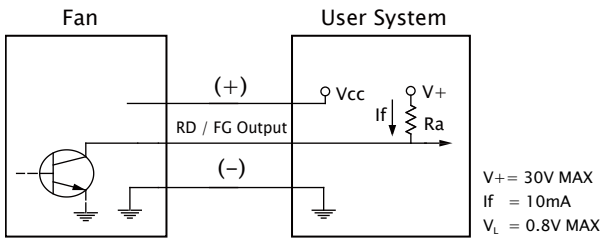

[RD Signal]

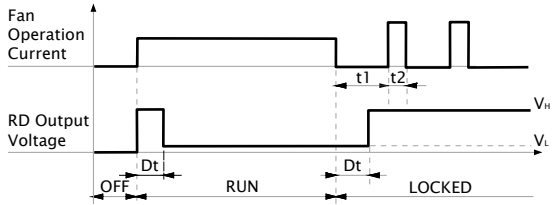

[FG Signal]

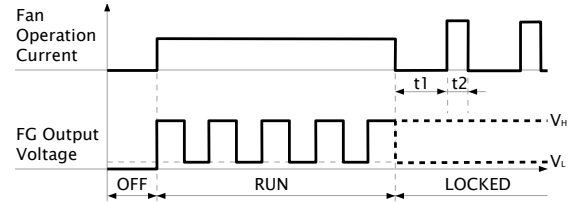
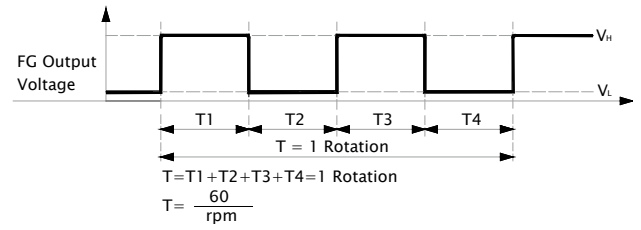

80x80x80 mm

122.0~151.5 CFM



■ Specification

Model	Bearing	Rated Voltage	Power Current	Power Consumption	Speed	Airflow	Static Pressure	Noise	Weight	Curve
	2BALL Sleeve	(VDC)	(mA)	(WATTS)	(RPM)	(CFM)	(inch-H ₂ O)	(dB(A))	(g)	
PF80801BX-0000-A9H	☉	12	6800	81.60	15600/14100	151.5	5.44	80.4	464.0	1
PF80801B1-0000-A9H	☉	12	3500	42.00	12600/11300	122.0	3.66	75.1	464.0	2

■ Function F Type : G9H / PWM : S9H

■ Air Flow-Static Pressure Characteristics

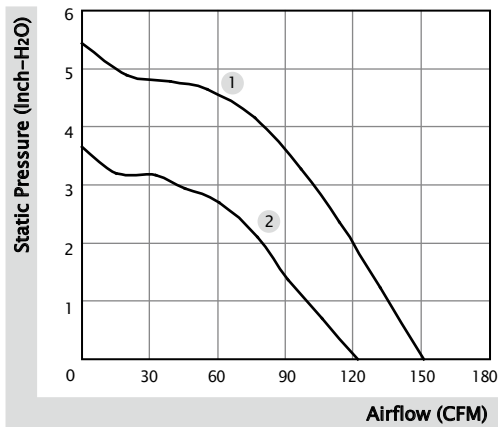

■ External Dimensions(mm)

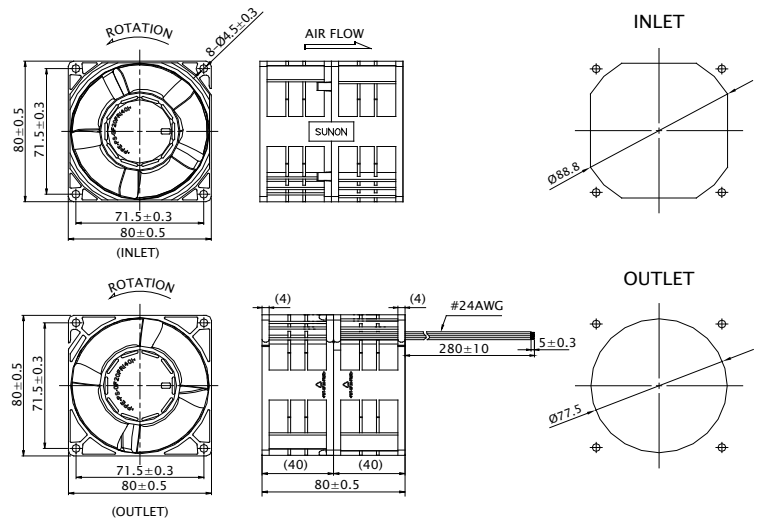

※ All model could be customized. Please contact with Sunon Sales.

※ Specifications are subject to change without notice. Please Visit SUNON website at www.sunon.com for update information.

■ FG Output Signal

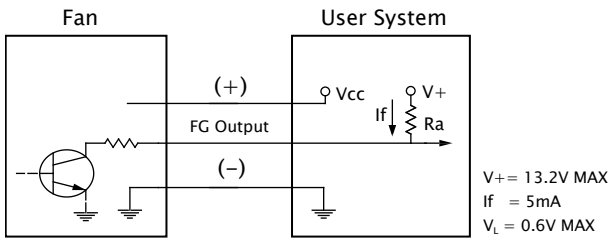

[FG Signal]

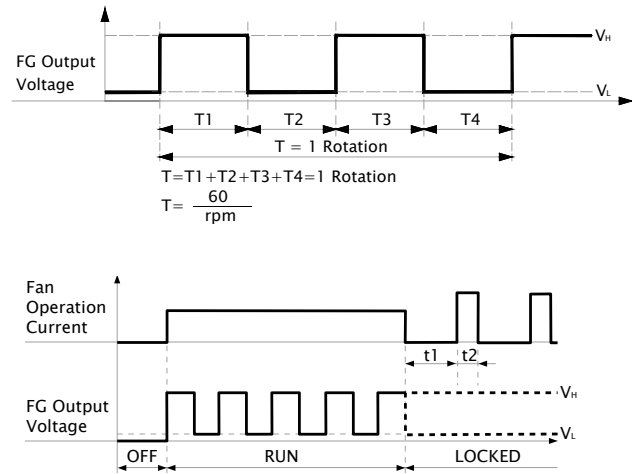

■ PWM Input Signal

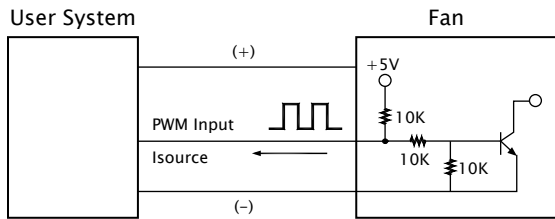

PWM FREQUENCY: 25KHZ
 I_{source} = 0.5mA at PWM Input Voltage 0V
 The speed is default to be maximum if PWM input pin is unconnected.
 Min. start up duty cycle is 10%.

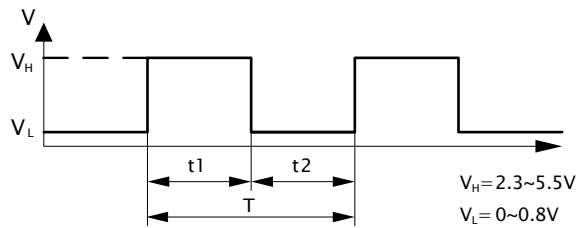

1. Period : $T = \frac{1}{f_{PWM}} = t1 + t2(\text{sec})$
2. Duty Cycle (D.C.) : $\frac{t1}{t1+t2} \times 100 = \frac{t1}{T} \times 100(\%)$

■ PWM Curve

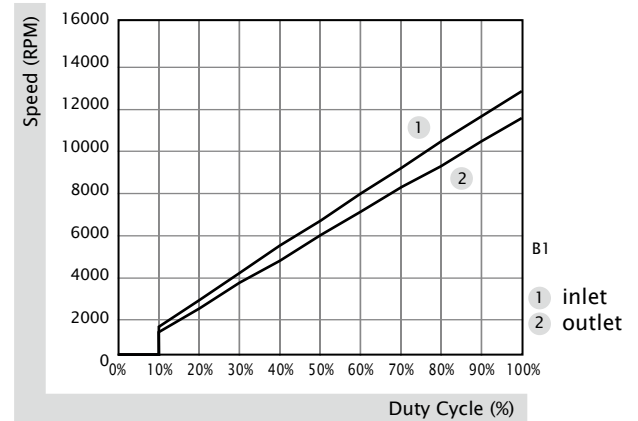
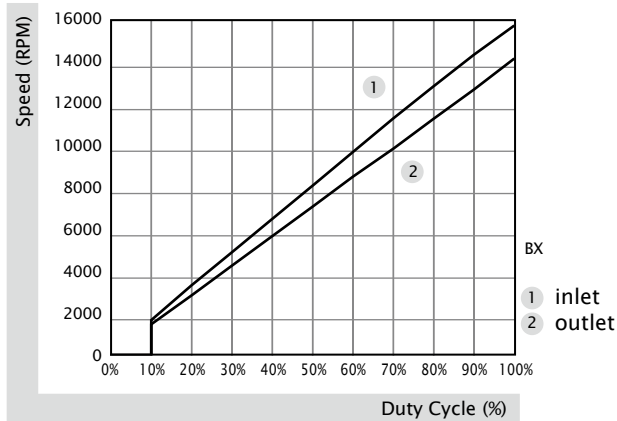

92x92x25 mm

65.0~75.0 CFM



■ Specification

	Bearing	Rated Voltage	Power Current	Power Consumption	Speed	Airflow	Static Pressure	Noise	Weight	Curve
	● VAPO	(VDC)	(mA)	(WATTS)	(RPM)	(CFM)	(inch-H ₂ O)	(dB(A))	(g)	
PF92251V1-10000-A99	●	12	370	4.44	4500	75.0	0.35	45.5	106.0	1
PF92251V2-10000-A99	●	12	280	3.36	4200	70.0	0.30	43.7	106.0	2
PF92251V3-10000-A99	●	12	230	2.76	3900	65.0	0.25	41.6	106.0	3
PF92252V1-10000-A99	●	24	210	5.04	4500	75.0	0.35	45.5	106.0	1
PF92252V2-10000-A99	●	24	145	3.48	4200	70.0	0.30	43.7	106.0	2
PF92252V3-10000-A99	●	24	126	3.03	3900	65.0	0.25	41.6	106.0	3

■ Function R Type : F99 / F Type : G99 / PWM : H99, Q99, S99

■ Air Flow-Static Pressure Characteristics

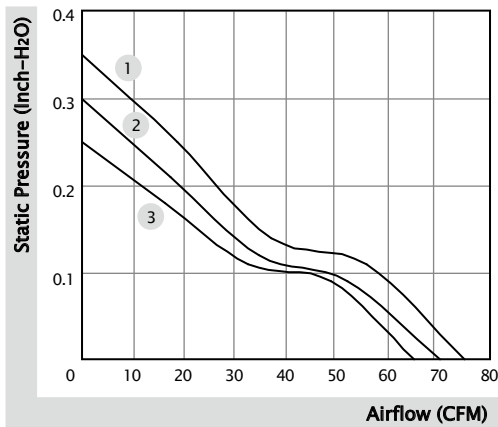

■ External Dimensions(mm)

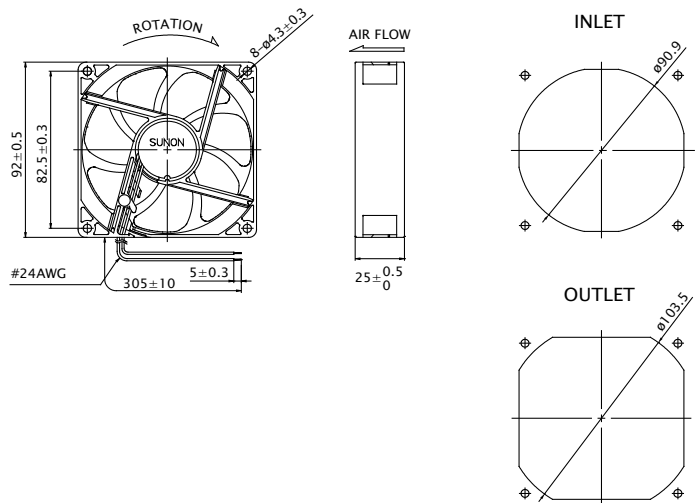

※ All model could be customized. Please contact with Sunon Sales.

※ Specifications are subject to change without notice. Please Visit SUNON website at www.sunon.com for update information.

■ RD / FG Output Signal

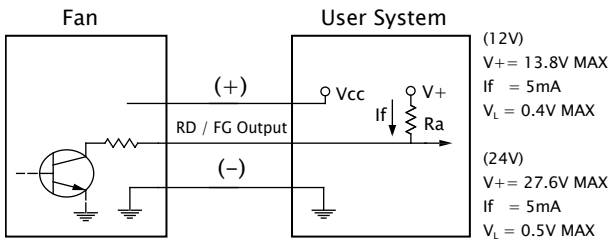

[RD Signal]

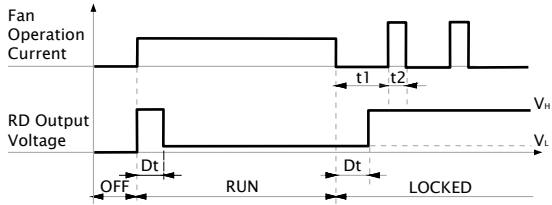

[FG Signal]

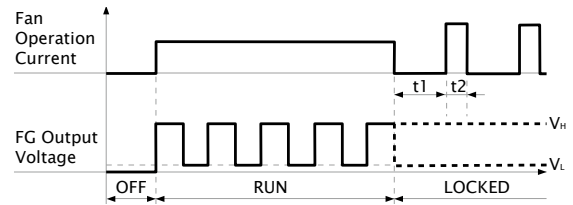
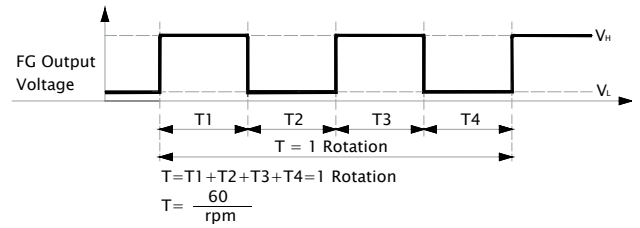

■ PWM Input Signal

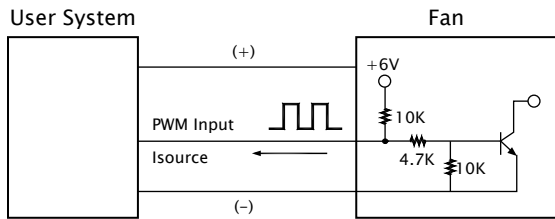

PWM FREQUENCY: 25KHZ
 Isource=0.6mA at PWM Input Voltage 0V
 The speed is default to be maximum if PWM input pin is unconnected.

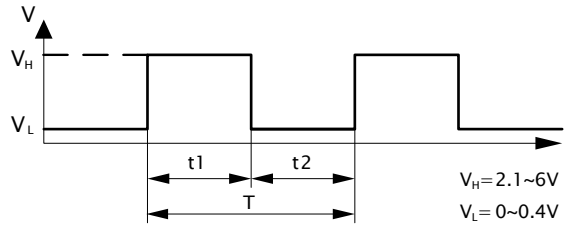

1. Period : $T = \frac{1}{f_{PWM}} = t1 + t2(\text{sec})$

2. Duty Cycle (D.C.) : $\frac{t1}{t1+t2} \times 100 = \frac{t1}{T} \times 100(\%)$

■ PWM Curve

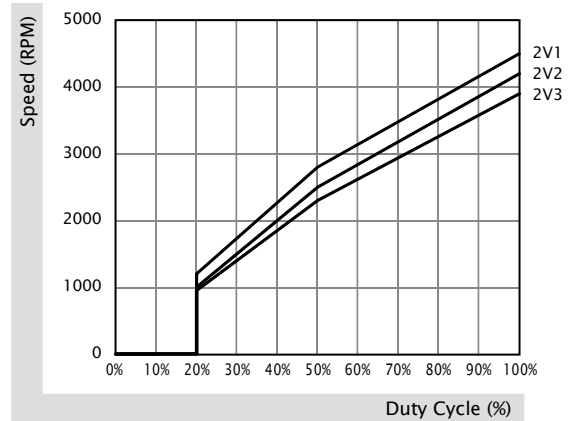
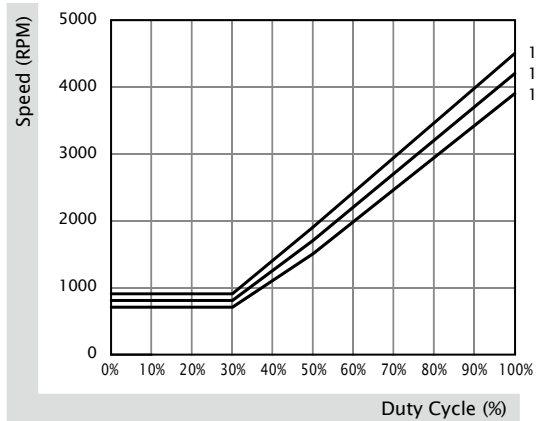

92x92x25 mm

65.0~75.0 CFM



■ Specification

Model	Bearing	Rated Voltage	Power Current	Power Consumption	Speed	Airflow	Static Pressure	Noise	Weight	Curve
	2BALL Sleeve	(VDC)	(mA)	(WATTS)	(RPM)	(CFM)	(inch-H ₂ O)	(dB(A))	(g)	
PF92251B1-10000-A99	☉	12	360	4.32	4500	75.0	0.35	46.1	103.0	1
PF92251B2-10000-A99	☉	12	275	3.30	4200	70.0	0.30	44.0	103.0	2
PF92251B3-10000-A99	☉	12	225	2.70	3900	65.0	0.25	41.8	103.0	3
PF92252B1-10000-A99	☉	24	205	4.92	4500	75.0	0.35	46.1	103.0	1

■ Function R Type : F99 / F Type : G99 / PWM : H99, Q99, S99

■ Air Flow-Static Pressure Characteristics

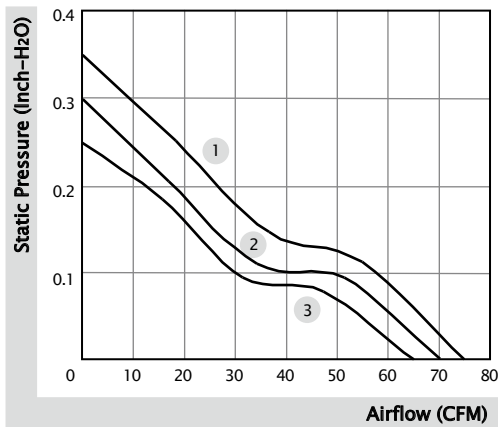

■ External Dimensions(mm)

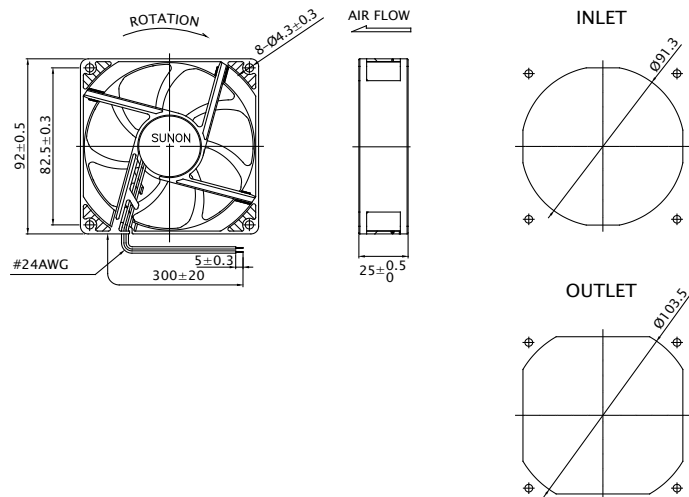

※ All model could be customized. Please contact with Sunon Sales.

※ Specifications are subject to change without notice. Please Visit SUNON website at www.sunon.com for update information.

■ RD / FG Output Signal

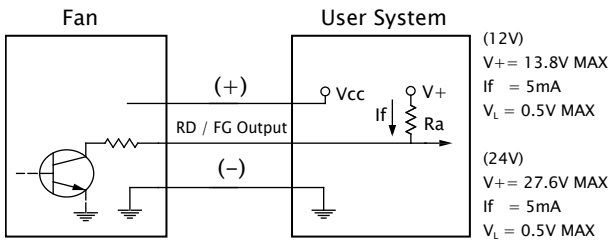

[RD Signal]

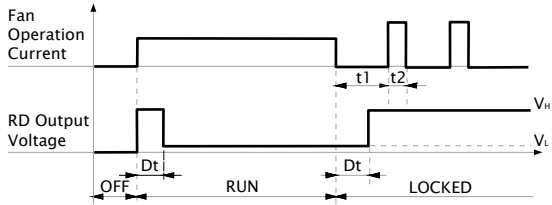

[FG Signal]

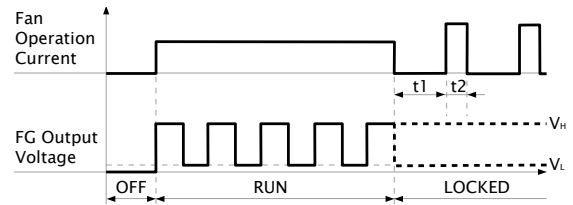
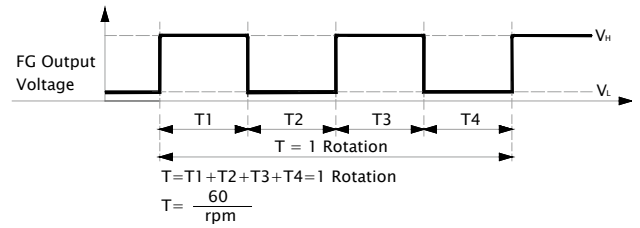

■ PWM Input Signal

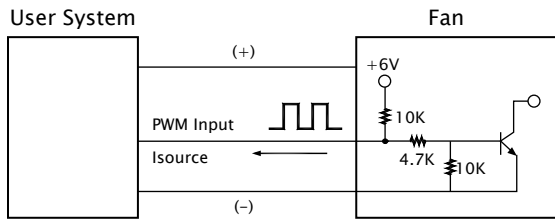

PWM FREQUENCY: 25KHZ
 Isource=0.6mA at PWM Input Voltage 0V
 The speed is default to be maximum if PWM input pin is unconnected.

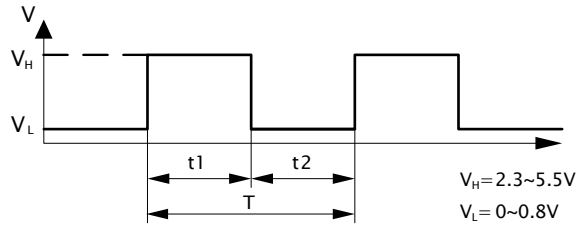

1. Period : $T = \frac{1}{f_{PWM}} = t1 + t2(\text{sec})$

2. Duty Cycle (D.C.) : $\frac{t1}{t1+t2} \times 100 = \frac{t1}{T} \times 100(\%)$

■ PWM Curve

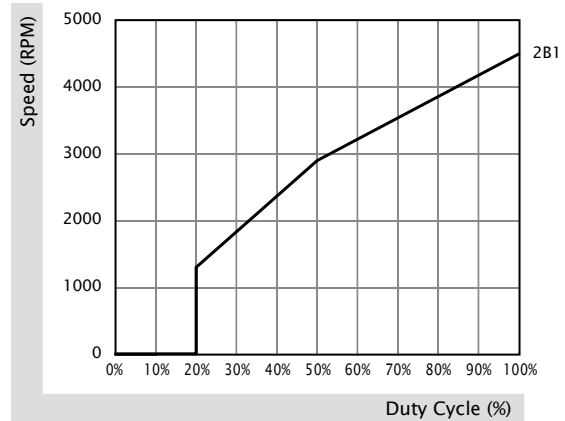
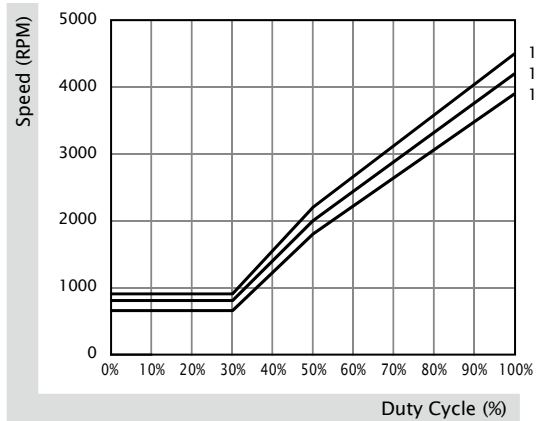

92x92x25 mm

39.5~51.5 CFM



■ Specification

	Bearing	Rated Voltage	Power Current	Power Consumption	Speed	Airflow	Static Pressure	Noise	Weight	Curve
	● VAPO	(VDC)	(mA)	(WATTS)	(RPM)	(CFM)	(inch-H ₂ O)	(dB(A))	(g)	
MF92251V1-10000-A99	●	12	140	1.68	3000	51.5	0.15	34.0	92.0	1
MF92251V2-10000-A99	●	12	105	1.26	2700	45.0	0.13	32.0	92.0	2
MF92251V3-10000-A99	●	12	75	0.90	2400	39.5	0.10	28.0	92.0	3
MF92252V1-10000-A99	●	24	75	1.80	3000	51.5	0.15	34.0	92.0	1
MF92252V2-10000-A99	●	24	55	1.32	2700	45.0	0.13	32.0	92.0	2
MF92252V3-10000-A99	●	24	42	1.01	2400	39.5	0.10	28.0	92.0	3
Model	○ 2BALL Sleeve	(VDC)	(mA)	(WATTS)	(RPM)	(CFM)	(inch-H ₂ O)	(dB(A))	(g)	
EF92251S1-10000-A99	○	12	140	1.68	3000	51.5	0.15	34.0	92.0	1
EF92251S2-10000-A99	○	12	110	1.32	2700	45.0	0.13	32.0	92.0	2
EF92251S3-10000-A99	○	12	80	0.96	2400	39.5	0.10	28.0	92.0	3
EF92252S1-10000-A99	○	24	60	1.44	3000	51.5	0.15	34.0	92.0	1

- Function (MF Series) R Type : F99 / F Type : G99
- (EF Series, Speed 1) R Type : F99 / F Type : G99
- (EF Series, Speed 2,3) F Type : G99

■ Air Flow-Static Pressure Characteristics

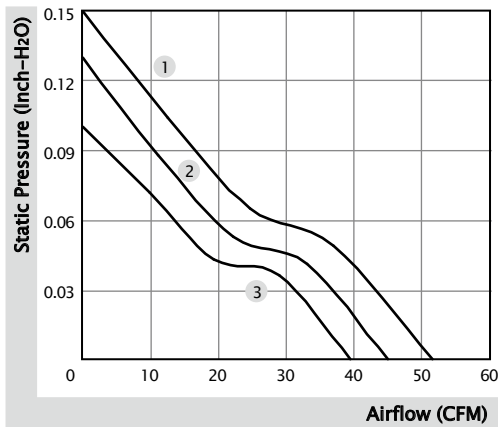

■ External Dimensions(mm)

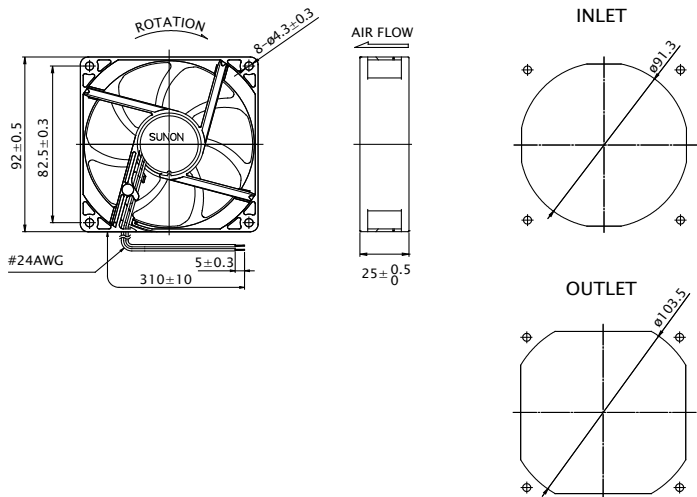

※ All model could be customized. Please contact with Sunon Sales.
 ※ Specifications are subject to change without notice. Please Visit SUNON website at www.sunon.com for update information.

■ RD / FG Output Signal

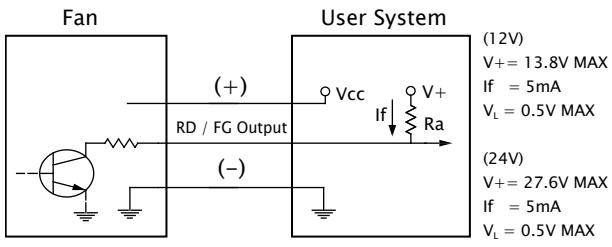

[RD Signal]

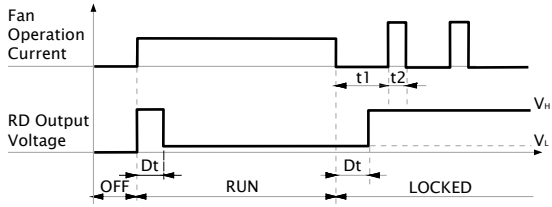

[FG Signal]

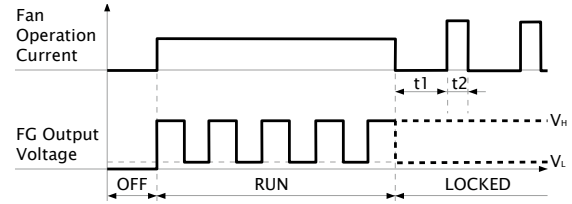
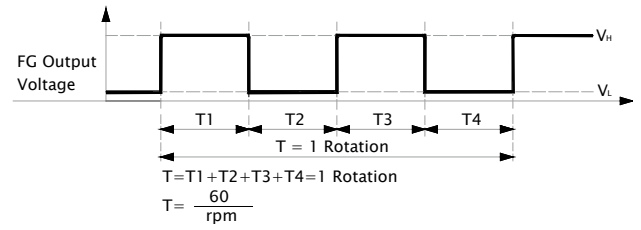

92x92x25 mm

39.5~55.0 CFM



■ Specification

Model	Bearing	Rated Voltage	Power Current	Power Consumption	Speed	Airflow	Static Pressure	Noise	Weight	Curve
	2BALL Sleeve	(VDC)	(mA)	(WATTS)	(RPM)	(CFM)	(inch-H ₂ O)	(dB(A))	(g)	
EE92251BX-0000-A99	☉	12	190	2.30	3400	55.0	0.21	37.5	89.0	1
EE92251B1-0000-A99	☉	12	165	2.00	3000	51.5	0.15	34.0	94.0	2
EE92251B2-0000-999	☉	12	135	1.60	2700	45.0	0.13	32.0	94.0	3
EE92251B3-0000-999	☉	12	105	1.30	2400	39.5	0.10	28.0	94.0	4
EE92252BX-0000-A99	☉	24	100	2.40	3400	55.0	0.21	37.5	89.0	1
EE92252B1-0000-A99	☉	24	87	2.10	3000	51.5	0.15	34.0	94.0	2
EE92252B2-0000-999	☉	24	70	1.70	2700	45.0	0.13	32.0	94.0	3
EE92252B3-0000-999	☉	24	57	1.40	2400	39.5	0.10	28.0	94.0	4

■ Function (Speed X, 1) R Type : F99 / F Type : G99
(Speed 2, 3) F Type : C99

■ Air Flow-Static Pressure Characteristics

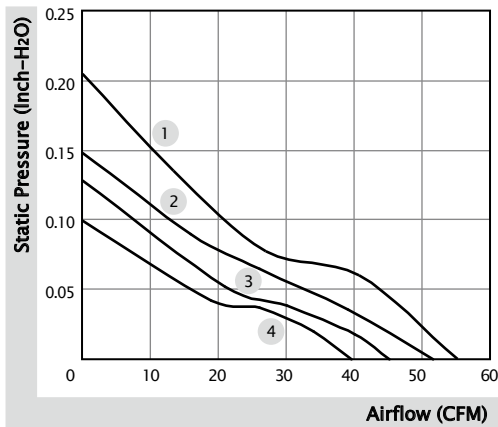

■ External Dimensions(mm)

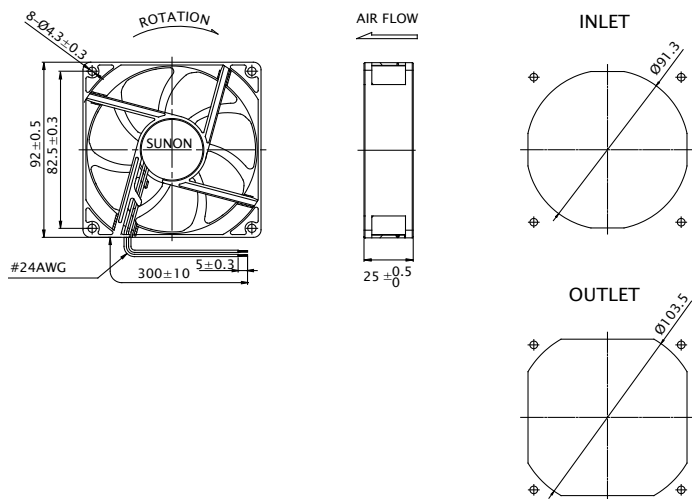

※ All model could be customized. Please contact with Sunon Sales.

※ Specifications are subject to change without notice. Please Visit SUNON website at www.sunon.com for update information.

■ RD / FG Output Signal

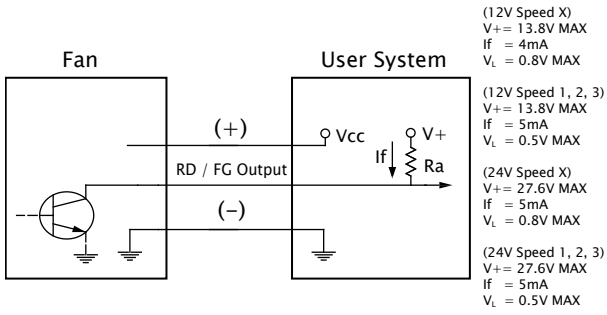

[RD Signal]

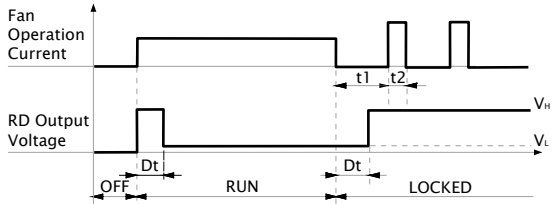

[FG Signal]

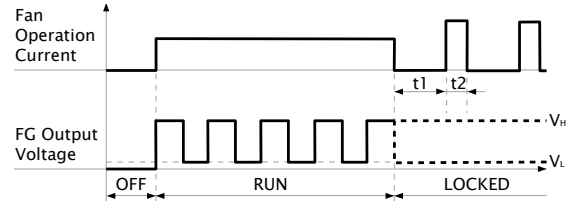
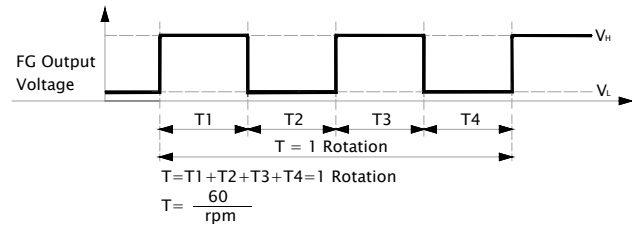

92x92x25 mm

28.4 CFM



■ Specification

	Bearing	Rated Voltage	Power Current	Power Consumption	Speed	Airflow	Static Pressure	Noise	Weight	Curve
	● VAPO	(VDC)	(mA)	(WATTS)	(RPM)	(CFM)	(inch-H ₂ O)	(dB(A))	(g)	
HA92251V4-10000-A99	●	12	45	0.54	1700	28.4	0.05	17.7	92.0	1

■ Function R Type : F99 / F Type : G99

■ Air Flow-Static Pressure Characteristics

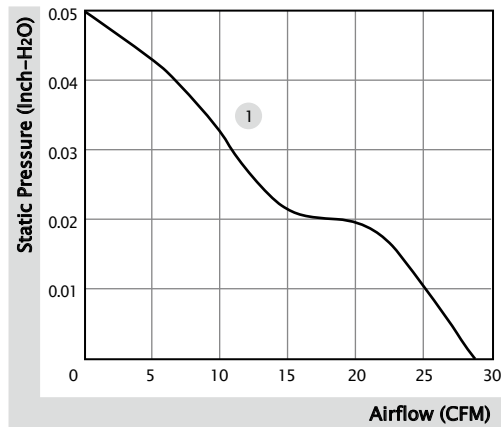

■ External Dimensions(mm)

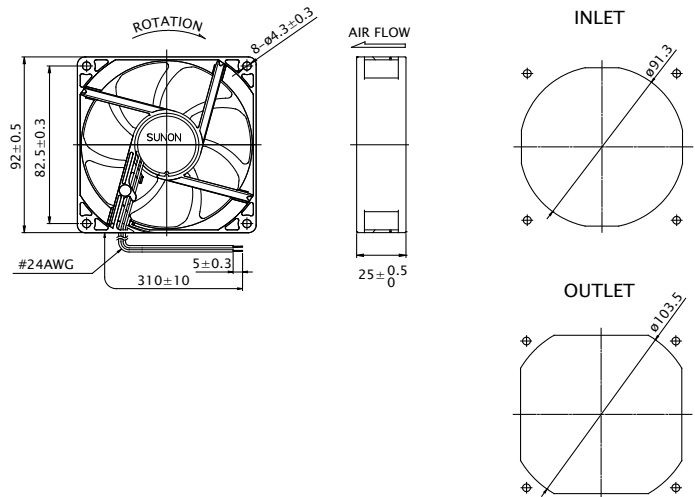

※ All model could be customized. Please contact with Sunon Sales.

※ Specifications are subject to change without notice. Please Visit SUNON website at www.sunon.com for update information.

■ RD / FG Output Signal

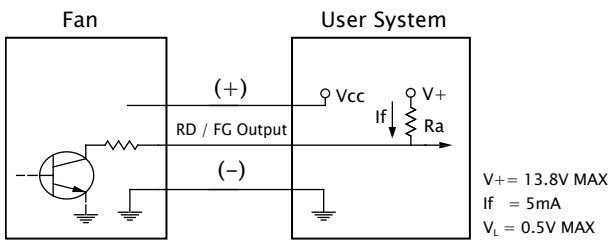

[FG Signal]

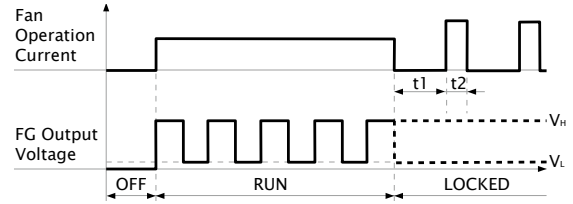
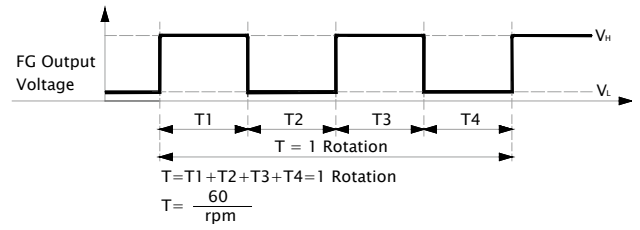

92x92x25 mm (IP68)

39.5~75.0 CFM



■ Specification

Model	Bearing	Rated Voltage	Power Current	Power Consumption	Speed	Airflow	Static Pressure	Noise	Weight	Curve
	2BALL Sleeve	(VDC)	(mA)	(WATTS)	(RPM)	(CFM)	(inch-H ₂ O)	(dB(A))	(g)	
GF92251B1-0000-AE9	☉	12	393	4.72	4500	75.0	0.35	47.0	113.0	1
GF92251B2-0000-AE9	☉	12	300	3.60	4200	70.0	0.30	45.0	113.0	2
GF92251B3-0000-AE9	☉	12	230	2.76	3900	65.0	0.25	43.0	113.0	3
GF92251B5-0000-AE9	☉	12	165	1.98	3000	51.5	0.15	34.0	99.0	4
GF92251B6-0000-AE9	☉	12	135	1.62	2700	45.0	0.13	32.0	99.0	5
GF92251B7-0000-AE9	☉	12	91	1.10	2400	39.5	0.10	28.0	99.0	6
GE92252B1-0000-AE9	☉	24	220	5.28	4500	75.0	0.35	47.0	113.0	1
GE92252B2-0000-AE9	☉	24	180	4.32	4200	70.0	0.30	45.0	113.0	2
GE92252B3-0000-AE9	☉	24	155	3.72	3900	65.0	0.25	43.0	113.0	3
GF92252B5-0000-AE9	☉	24	87	2.09	3000	51.5	0.15	34.0	99.0	4
GF92252B6-0000-AE9	☉	24	65	1.56	2700	45.0	0.13	32.0	99.0	5
GF92252B7-0000-AE9	☉	24	47	1.13	2400	39.5	0.10	28.0	99.0	6

■ Function (Speed 1, 2, 3) R Type : FE9 / F Type : GE9 / PWM : HE9, QE9, SE9
 (Speed 4, 5, 6) R Type : FE9 / F Type : GE9

■ Air Flow-Static Pressure Characteristics

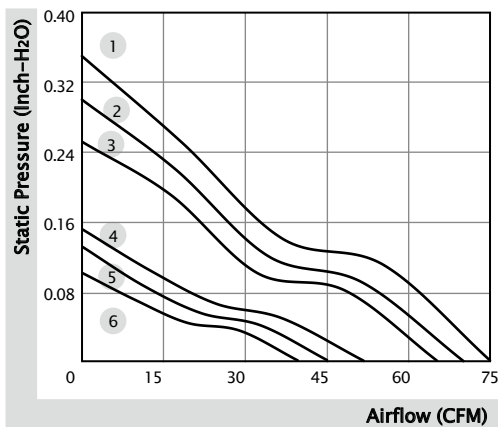

■ External Dimensions(mm)

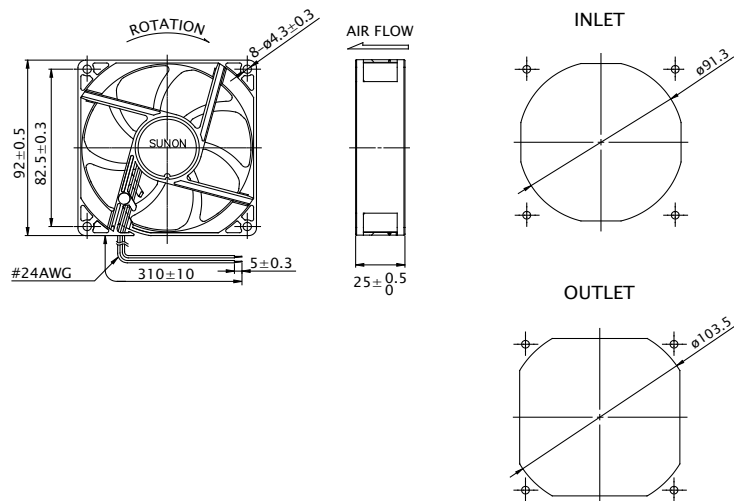

※ All model could be customized. Please contact with Sunon Sales.

※ Specifications are subject to change without notice. Please Visit SUNON website at www.sunon.com for update information.

■ RD / FG Output Signal

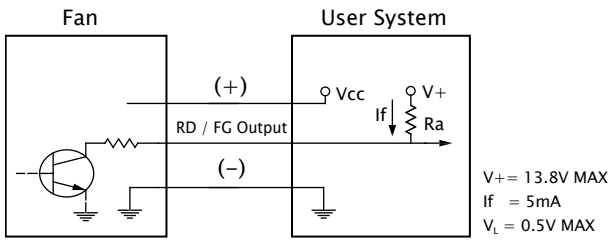

[RD Signal]

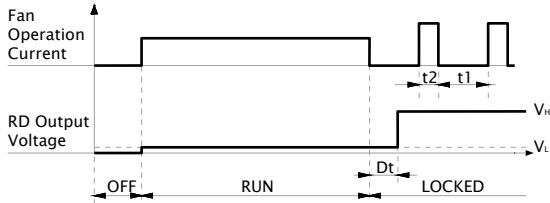

[FG Signal]

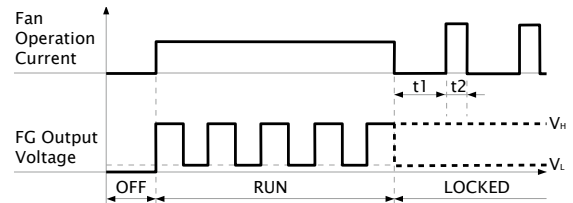
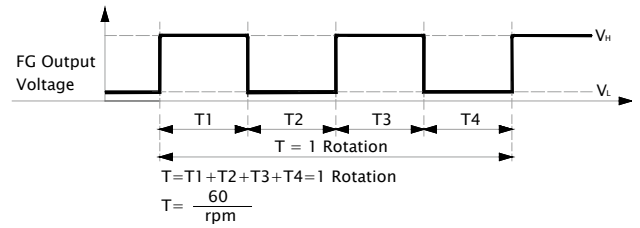

■ PWM Input Signal

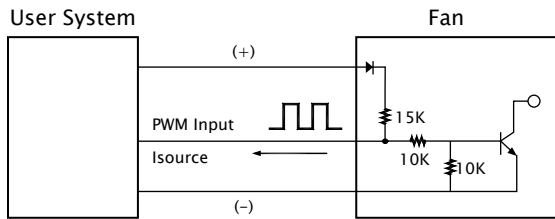

PWM FREQUENCY: 25KHZ
 Isource=0.8mA at PWM Input Voltage 0V
 The speed is default to be maximum if PWM input pin is unconnected.

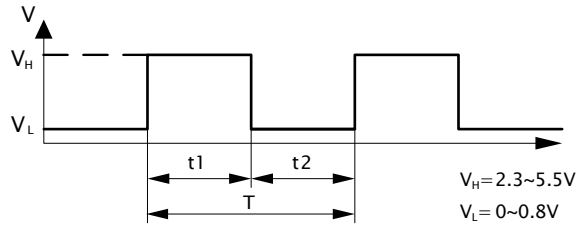

1. Period : $T = \frac{1}{f_{PWM}} = t1 + t2(\text{sec})$

2. Duty Cycle (D.C.) : $\frac{t1}{t1+t2} \times 100 = \frac{t1}{T} \times 100(\%)$

■ PWM Curve

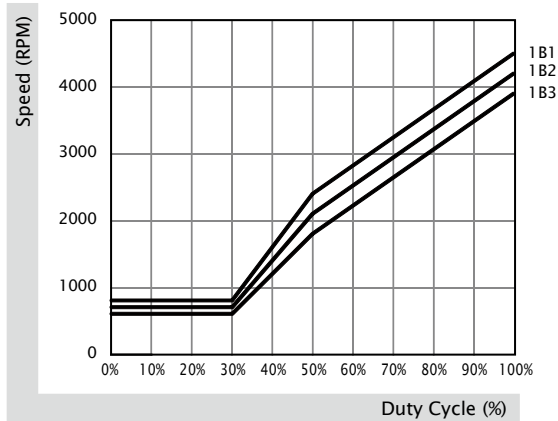

92x92x25 mm (GR487)

39.5~51.5 CFM



■ Specification

Model	Bearing	Rated Voltage	Power Current	Power Consumption	Speed	Airflow	Static Pressure	Noise	Weight	Curve
	2BALL Sleeve	(VDC)	(mA)	(WATTS)	(RPM)	(CFM)	(inch-H ₂ O)	(dB(A))	(g)	
GF92251B5-0000-AD9	☉	12	165	1.98	3000	51.5	0.15	34.0	99.0	1
GF92251B6-0000-AD9	☉	12	135	1.62	2700	45.0	0.13	32.0	99.0	2
GF92251B7-0000-AD9	☉	12	91	1.10	2400	39.5	0.10	28.0	99.0	3
GF92252B5-0000-AD9	☉	24	87	2.09	3000	51.5	0.15	34.0	99.0	1
GF92252B6-0000-AD9	☉	24	65	1.56	2700	45.0	0.13	32.0	99.0	2
GF92252B7-0000-AD9	☉	24	47	1.13	2400	39.5	0.10	28.0	99.0	3

■ Function R Type : FD9 / F Type : GD9

■ Air Flow-Static Pressure Characteristics

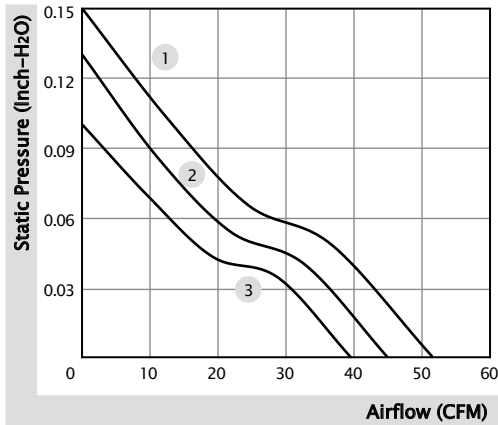

■ External Dimensions(mm)

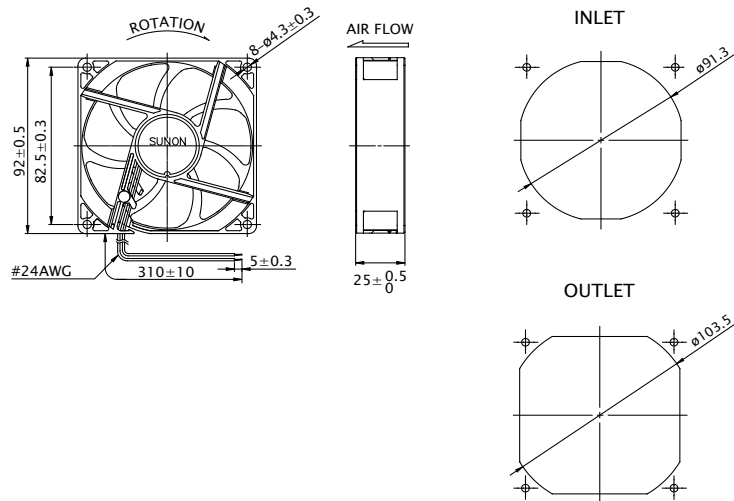

※ All model could be customized. Please contact with Sunon Sales.

※ Specifications are subject to change without notice. Please Visit SUNON website at www.sunon.com for update information.

■ RD / FG Output Signal

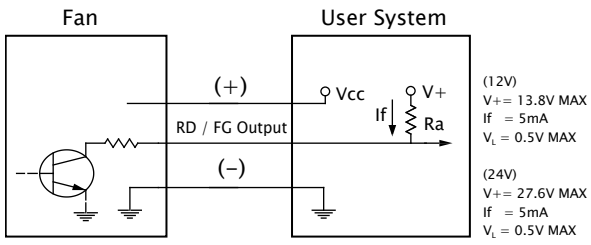

[RD Signal]

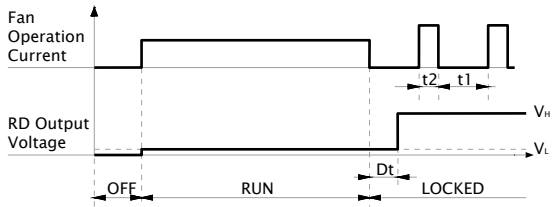

[FG Signal]

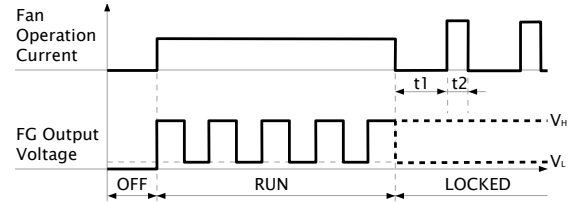
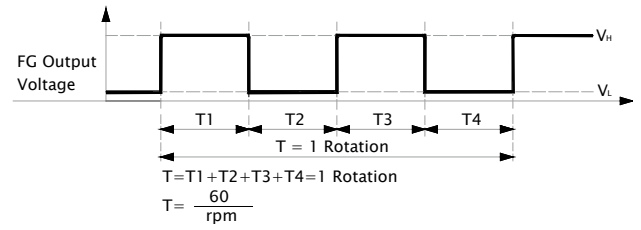

92x92x38 mm

138.1~182.4 CFM



■ Specification

Model	Bearing	Rated Voltage	Power Current	Power Consumption	Speed	Airflow	Static Pressure	Noise	Weight	Curve
	2BALL O Sleeve	(VDC)	(mA)	(WATTS)	(RPM)	(CFM)	(inch-H ₂ O)	(dB(A))	(g)	
PF92381BX-0000-A99	☉	12	4000	48.00	13000	182.4	2.94	72.1	210.0	1
PF92381B1-0000-A99	☉	12	1700	20.40	9800	138.1	1.95	63.7	210.0	2

■ Function R Type : F99 / F Type : G99 / PWM : H99, Q99, S99

■ Air Flow-Static Pressure Characteristics

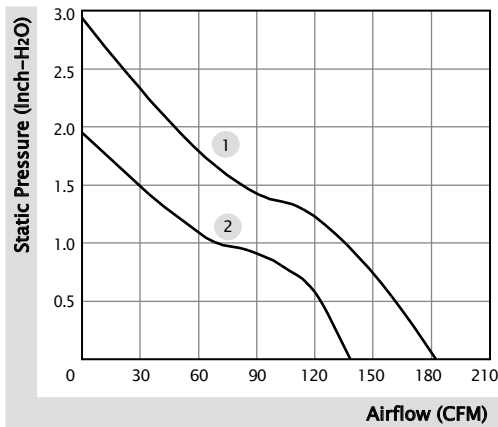

■ External Dimensions(mm)

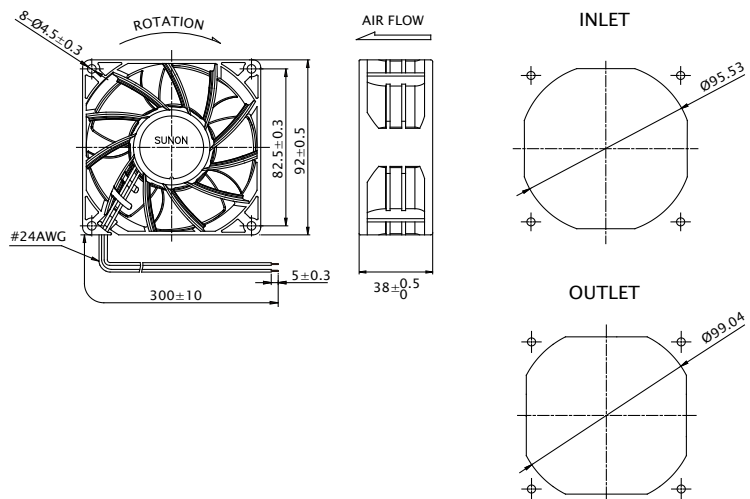

※ All model could be customized. Please contact with Sunon Sales.

※ Specifications are subject to change without notice. Please Visit SUNON website at www.sunon.com for update information.

■ RD / FG Output Signal

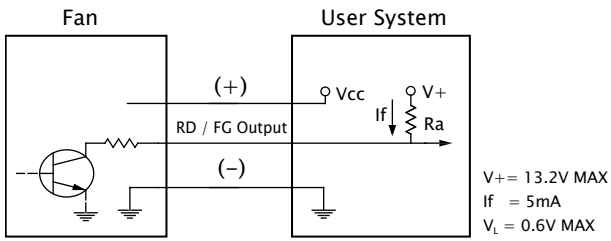

[RD Signal]

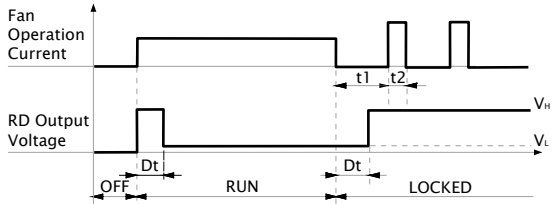

[FG Signal]

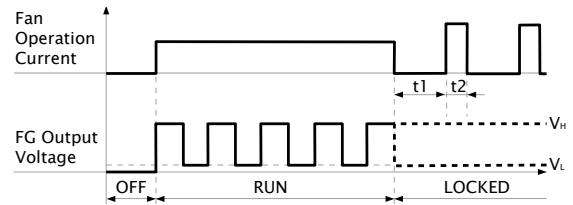
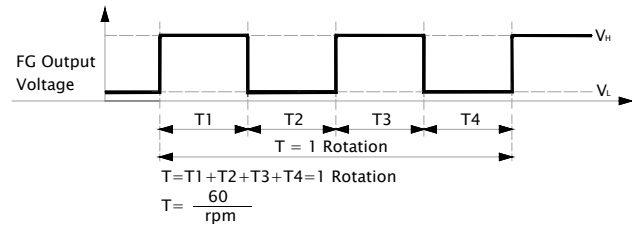

■ PWM Input Signal

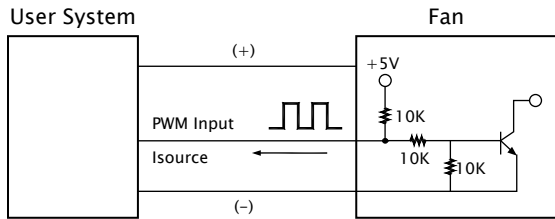

PWM FREQUENCY: 25KHZ
 Isource=0.5mA at PWM Input Voltage 0V
 The speed is default to be maximum if PWM input pin is unconnected.
 Min. start up duty cycle is 10%.

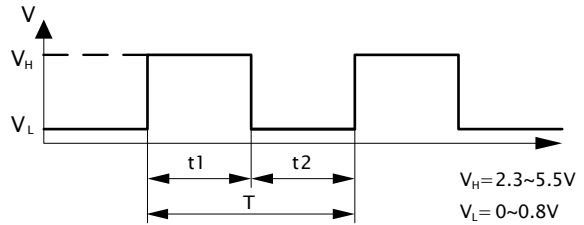

1. Period : $T = \frac{1}{f_{PWM}} = t1 + t2(\text{sec})$
2. Duty Cycle (D.C.) : $\frac{t1}{t1+t2} \times 100 = \frac{t1}{T} \times 100(\%)$

■ PWM Curve

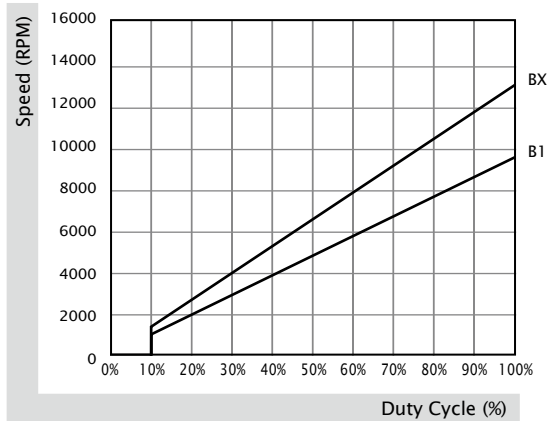

92x92x38 mm

91.7~120.2 CFM



■ Specification

Model	Bearing	Rated Voltage	Power Current	Power Consumption	Speed	Airflow	Static Pressure	Noise	Weight	Curve
	2BALL Sleeve	(VDC)	(mA)	(WATTS)	(RPM)	(CFM)	(inch-H ₂ O)	(dB(A))	(g)	
PMD1209PMB1-A (2).GN	☉	12	1040	12.5	4900	120.2	0.71	57.6	190.0	1
PMD1209PMB2-A (2).GN	☉	12	710	8.5	4400	106.3	0.56	53.8	190.0	2
PMD1209PMB3-A (2).GN	☉	12	470	5.6	3800	91.7	0.43	50.3	190.0	3
PMD2409PMB1-A (2).GN	☉	24	510	12.2	4900	120.2	0.71	57.6	190.0	1
PMD2409PMB2-A (2).GN	☉	24	400	9.6	4400	106.3	0.56	53.8	190.0	2
PMD2409PMB3-A (2).GN	☉	24	250	6.0	3800	91.7	0.43	50.3	190.0	3

■ Function R Type : (2).R.GN / F Type : (2).F.GN

■ Air Flow-Static Pressure Characteristics

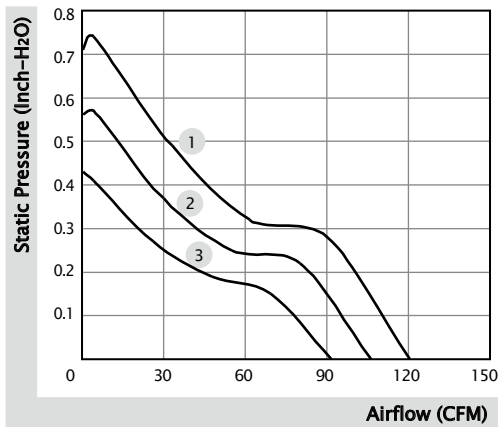

■ External Dimensions(mm)

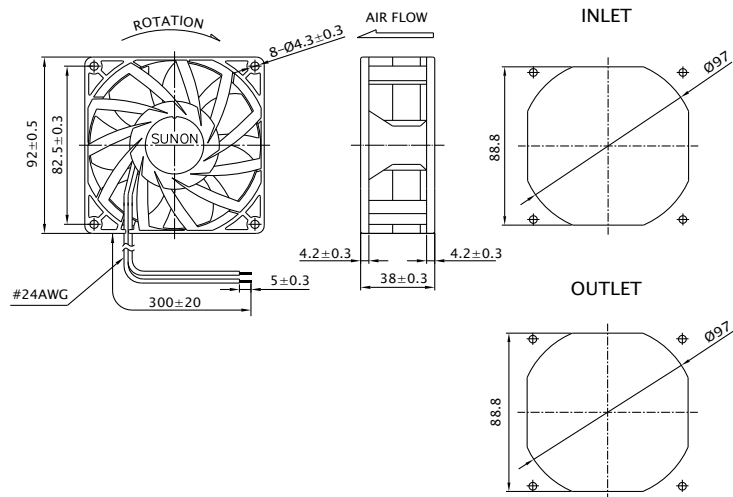

※ All model could be customized. Please contact with Sunon Sales.

※ Specifications are subject to change without notice. Please Visit SUNON website at www.sunon.com for update information.

■ RD / FG Output Signal

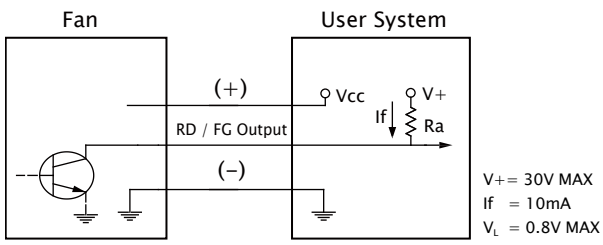

[RD Signal]

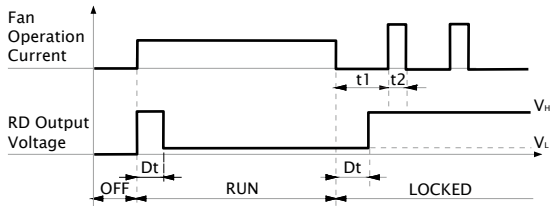

[FG Signal]

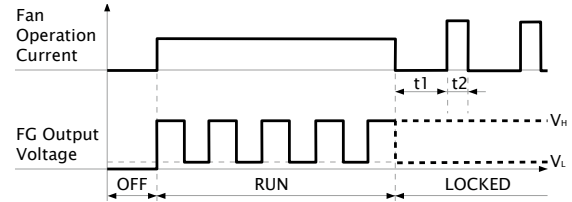
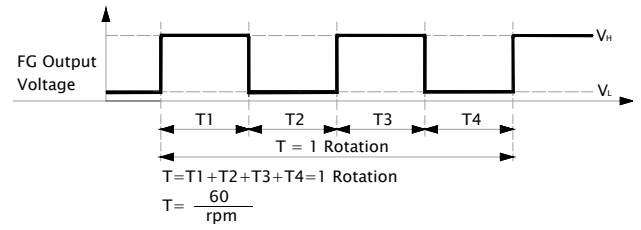

120x120x25 mm

120.0~150.0 CFM



■ Specification

Model	Bearing	Rated Voltage	Power Current	Power Consumption	Speed	Airflow	Static Pressure	Noise	Weight	Curve
	2BALL Sleeve	(VDC)	(mA)	(WATTS)	(RPM)	(CFM)	(inch-H ₂ O)	(dB(A))	(g)	
PMD1212PTB1-A (2).GN	☉	12	1000	12.0	4500	150.0	0.62	54.0	220.0	1
PMD1212PTB2-A (2).GN	☉	12	720	8.6	4000	133.0	0.50	51.0	220.0	2
PMD1212PTB3-A (2).GN	☉	12	540	6.5	3600	120.0	0.41	48.0	220.0	3
PMD2412PTB1-A (2).GN	☉	24	490	11.8	4500	150.0	0.62	54.0	220.0	1
PMD2412PTB3-A (2).GN	☉	24	280	6.7	3600	120.0	0.41	48.0	220.0	3

■ Function R Type : (2).R.GN / F Type : (2).F.GN

■ Air Flow-Static Pressure Characteristics

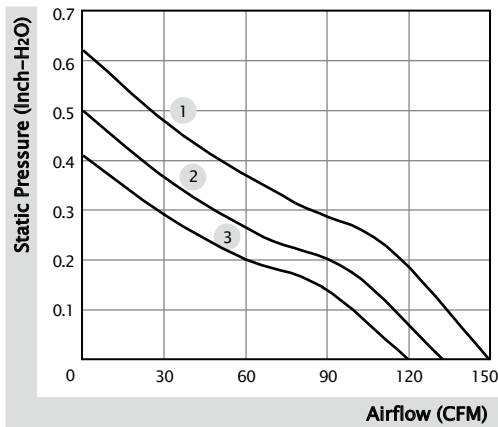

■ External Dimensions(mm)

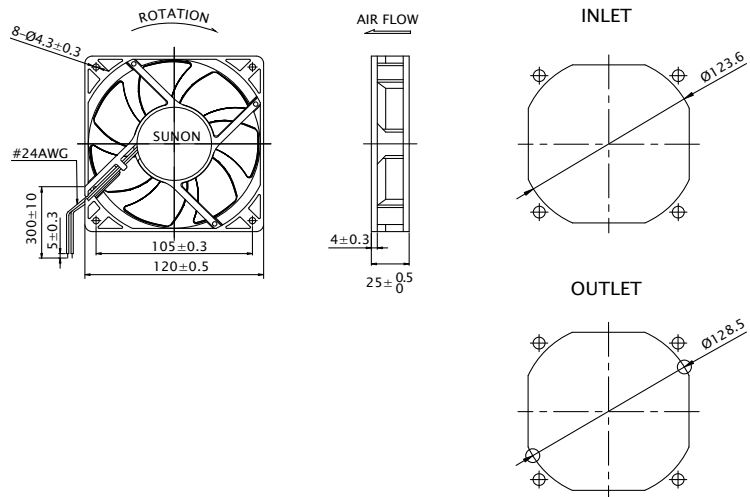

* All model could be customized. Please contact with Sunon Sales.

* Specifications are subject to change without notice. Please Visit SUNON website at www.sunon.com for update information.

■ RD / FG Output Signal

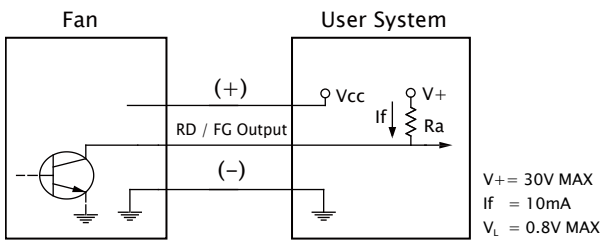

[RD Signal]

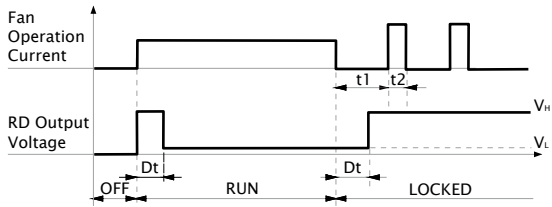

[FG Signal]

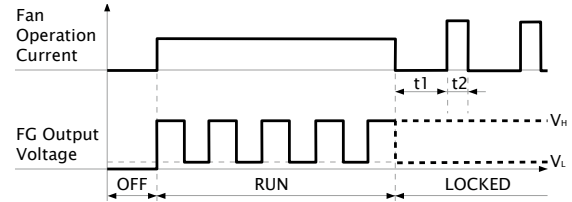
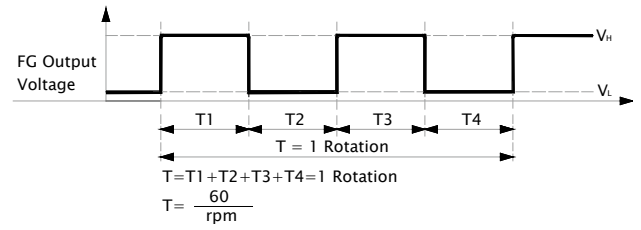

120x120x25 mm

75.0~108.2 CFM



■ Specification

	Bearing	Rated Voltage	Power Current	Power Consumption	Speed	Airflow	Static Pressure	Noise	Weight	Curve
	● VAPO	(VDC)	(mA)	(WATTS)	(RPM)	(CFM)	(inch-H ₂ O)	(dB(A))	(g)	
MFC0251V1-0000-A99	●	12	350	4.20	3100	108.2	0.28	44.5	162.0	1
MFC0251V2-0000-A99	●	12	250	3.00	2700	93.0	0.22	40.5	162.0	2
MFC0251V3-0000-A99	●	12	140	1.68	2200	75.0	0.16	34.0	162.0	3
MEC0252V1-0000-A99	●	24	207	5.00	3100	108.2	0.28	44.5	162.0	1
MEC0252V2-0000-A99	●	24	146	3.50	2700	93.0	0.22	40.5	162.0	2
MEC0252V3-0000-A99	●	24	84	2.00	2200	75.0	0.16	34.0	162.0	3
Model	⊙ 2BALL Sleeve	(VDC)	(mA)	(WATTS)	(RPM)	(CFM)	(inch-H ₂ O)	(dB(A))	(g)	
EEC0251B1-0000-A99	⊙	12	451	5.4	3100	108.2	0.28	44.5	157.0	1
EEC0251B2-0000-A99	⊙	12	279	3.4	2700	93.0	0.22	40.5	157.0	2
EEC0251B3-0000-A99	⊙	12	161	1.9	2200	75.0	0.16	34.0	157.0	3
EEC0252B1-0000-A99	⊙	24	207	5.0	3100	108.2	0.28	44.5	157.0	1
EEC0252B2-0000-A99	⊙	24	146	3.5	2700	93.0	0.22	40.5	157.0	2
EEC0252B3-0000-A99	⊙	24	84	2.0	2200	75.0	0.16	34.0	157.0	3
EEC0254B1-0000-A99	⊙	48	119	5.7	3100	108.2	0.28	44.5	157.0	1
EEC0254B2-0000-A99	⊙	48	79	3.8	2700	93.0	0.22	40.5	157.0	2
EEC0254B3-0000-A99	⊙	48	54	2.6	2200	75.0	0.16	34.0	157.0	3

■ Function R Type : F99 / F Type : G99

■ Air Flow-Static Pressure Characteristics

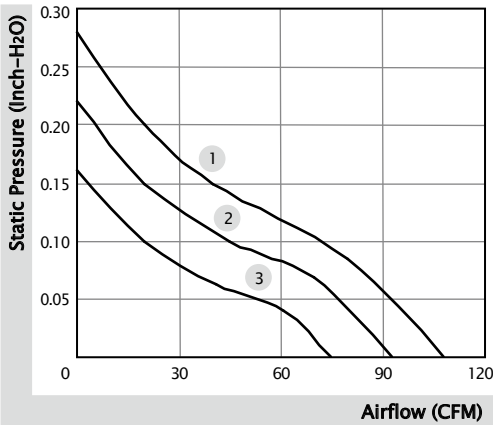

■ External Dimensions(mm)

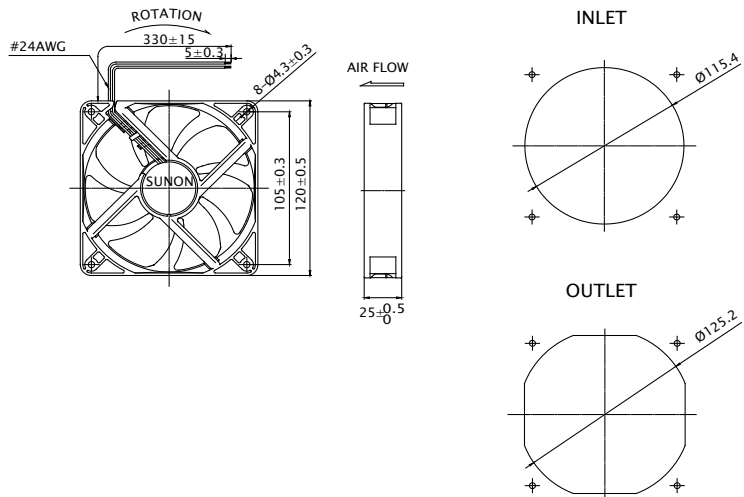

※ All model could be customized. Please contact with Sunon Sales.

※ Specifications are subject to change without notice. Please Visit SUNON website at www.sunon.com for update information.

■ RD / FG Output Signal

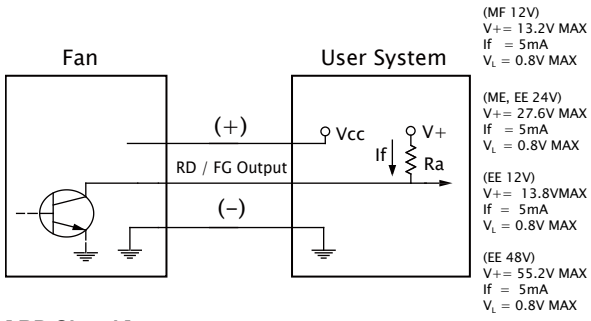

[RD Signal]

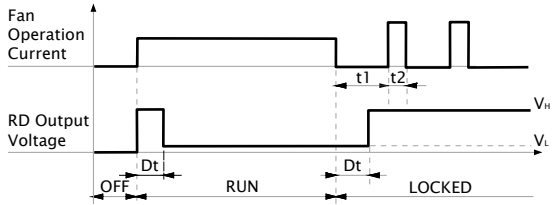

[FG Signal]

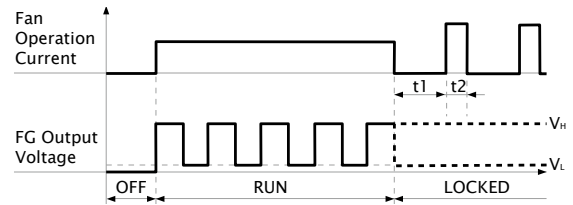
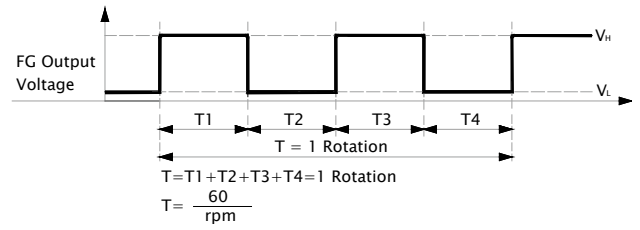

120x120x25 mm

55.0 CFM



■ Specification

Model	Bearing	Rated Voltage	Power Current	Power Consumption	Speed	Airflow	Static Pressure	Noise	Weight	Curve
	2BALL ○ Sleeve	(VDC)	(mA)	(WATTS)	(RPM)	(CFM)	(inch-H ₂ O)	(dB(A))	(g)	
HAC0251S4-0000-999	○	12	155	1.9	1600	55.0	0.06	29.6	99.0	1

■ Function F Type : C99

■ Air Flow-Static Pressure Characteristics

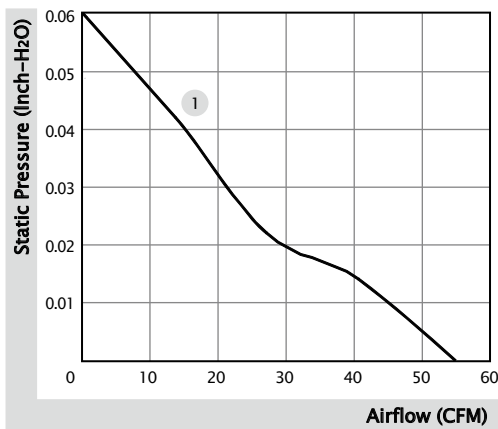

■ External Dimensions(mm)

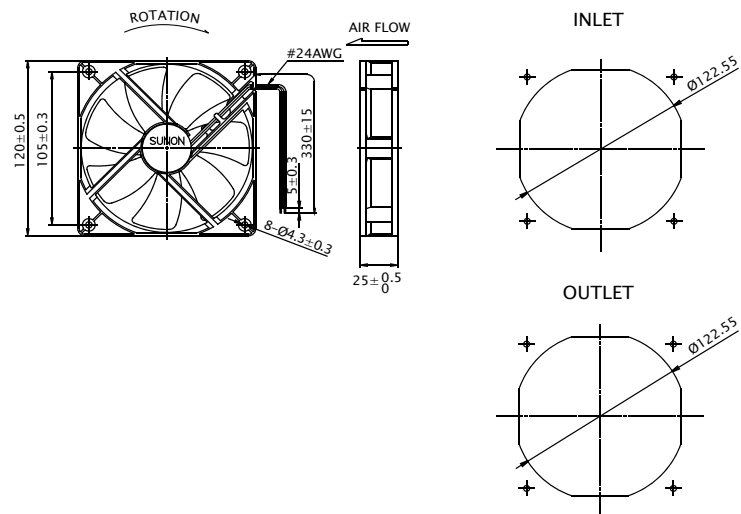

* All model could be customized. Please contact with Sunon Sales.

* Specifications are subject to change without notice. Please Visit SUNON website at www.sunon.com for update information.

■ RD / FG Output Signal

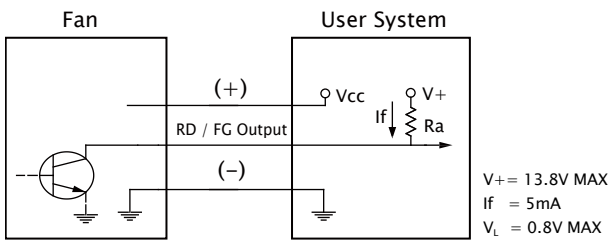

[FG Signal]

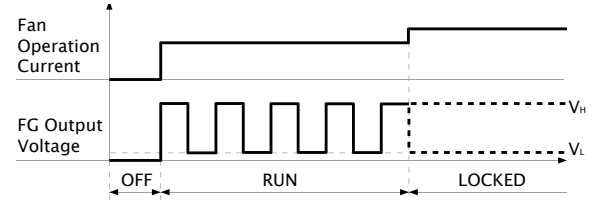
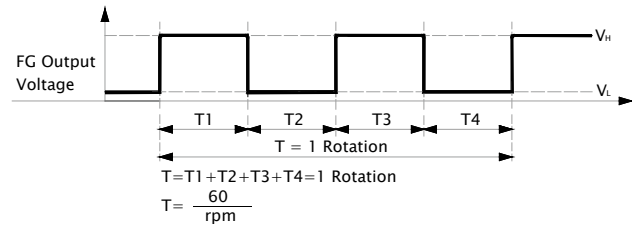

120x120x38 mm

170.0~190.0 CFM



■ Specification

Model	Bearing	Rated Voltage	Power Current	Power Consumption	Speed	Airflow	Static Pressure	Noise	Weight	Curve
	2BALL Sleeve	(VDC)	(mA)	(WATTS)	(RPM)	(CFM)	(inch-H ₂ O)	(dB(A))	(g)	
PMD1212PMB1-A (2).GN	☉	12	1600	19.2	4200	190.0	0.65	54.0	330.0	1
PMD1212PMB2-A (2).GN	☉	12	1200	14.4	3800	170.0	0.54	51.0	330.0	2
PMD2412PMB1-A (2).GN	☉	24	760	18.2	4200	190.0	0.65	54.0	330.0	1
PMD2412PMB2-A (2).GN	☉	24	570	13.7	3800	170.0	0.54	51.0	330.0	2

■ Function R Type : (2).R.GN / F Type : (2).F.GN

■ Air Flow-Static Pressure Characteristics

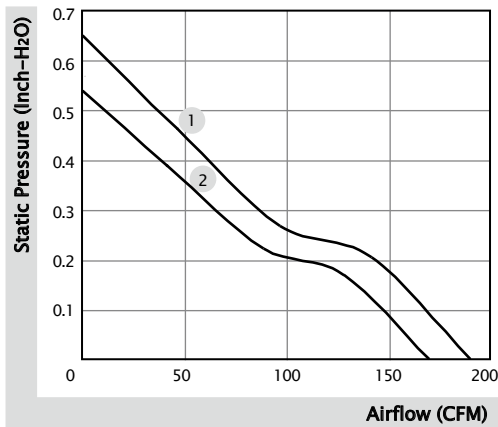

■ External Dimensions(mm)

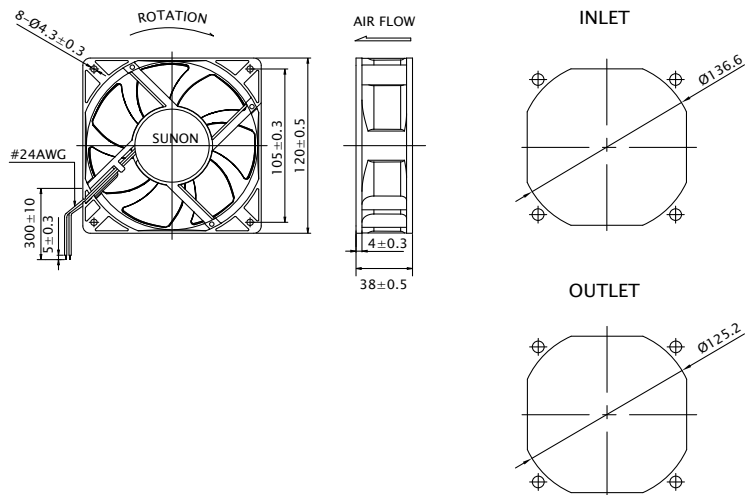

※ All model could be customized. Please contact with Sunon Sales.

※ Specifications are subject to change without notice. Please Visit SUNON website at www.sunon.com for update information.

■ RD / FG Output Signal

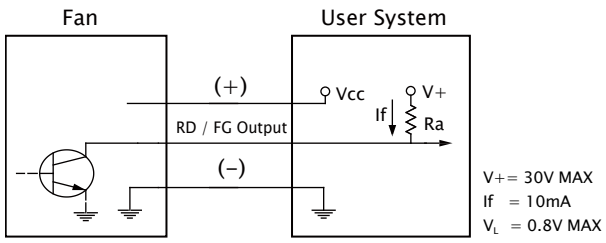

[RD Signal]

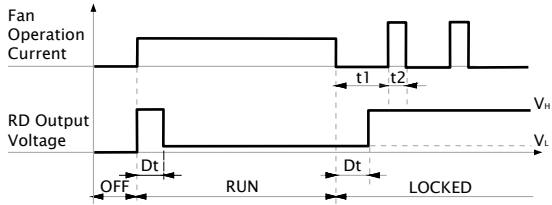

[FG Signal]

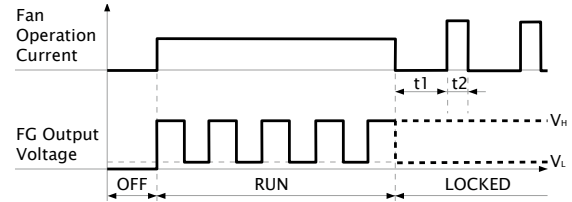
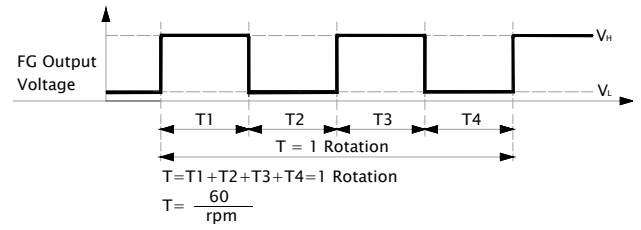

120x120x38 mm

93.0~138.0 CFM



■ Specification

	Bearing	Rated Voltage	Power Current	Power Consumption	Speed	Airflow	Static Pressure	Noise	Weight	Curve
	● VAPO	(VDC)	(mA)	(WATTS)	(RPM)	(CFM)	(inch-H ₂ O)	(dB(A))	(g)	
MEC0381V1-0000-A99	●	12	833	10.0	3100	138.0	0.36	48.0	218.0	1
MEC0381V2-0000-A99	●	12	421	5.1	2600	116.0	0.26	44.0	218.0	2
MEC0381V3-0000-A99	●	12	241	2.9	2100	93.0	0.18	37.0	218.0	3
MEC0382V1-0000-A99	●	24	383	9.2	3100	138.0	0.36	48.0	218.0	1
MEC0382V2-0000-A99	●	24	224	5.4	2600	116.0	0.26	44.0	218.0	2
MEC0382V3-0000-A99	●	24	130	3.1	2100	93.0	0.18	37.0	218.0	3
Model	⊙ 2BALL Sleeve	(VDC)	(mA)	(WATTS)	(RPM)	(CFM)	(inch-H ₂ O)	(dB(A))	(g)	
EEC0381B1-0000-A99	⊙	12	833	10.0	3100	138.0	0.36	48.0	214.0	1
EEC0381B2-0000-A99	⊙	12	421	5.1	2600	116.0	0.26	44.0	214.0	2
EEC0381B3-0000-A99	⊙	12	241	2.9	2100	93.0	0.18	37.0	214.0	3
EEC0382B1-0000-A99	⊙	24	383	9.2	3100	138.0	0.36	48.0	214.0	1
EEC0382B2-0000-A99	⊙	24	224	5.4	2600	116.0	0.26	44.0	214.0	2
EEC0382B3-0000-A99	⊙	24	130	3.1	2100	93.0	0.18	37.0	214.0	3
EEC0384B1-0000-A99	⊙	48	203	9.7	3100	138.0	0.36	48.0	214.0	1
EEC0384B2-0000-A99	⊙	48	120	5.8	2600	116.0	0.26	44.0	214.0	2
EEC0384B3-0000-A99	⊙	48	69	3.3	2100	93.0	0.18	37.0	214.0	3

■ Function R Type : F99 / F Type : G99

■ Air Flow-Static Pressure Characteristics

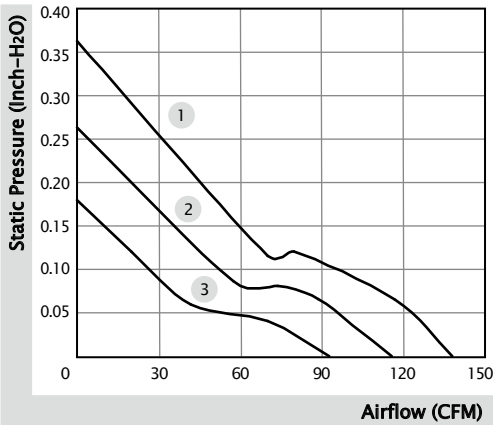

■ External Dimensions(mm)

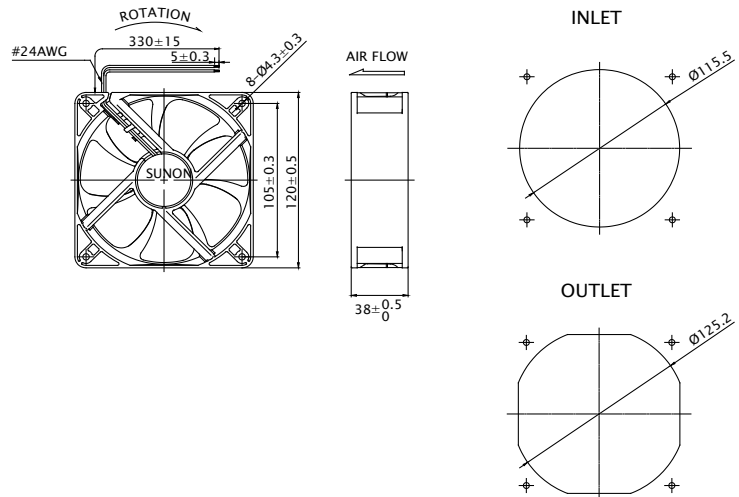

※ All model could be customized. Please contact with Sunon Sales.

※ Specifications are subject to change without notice. Please Visit SUNON website at www.sunon.com for update information.

■ RD / FG Output Signal

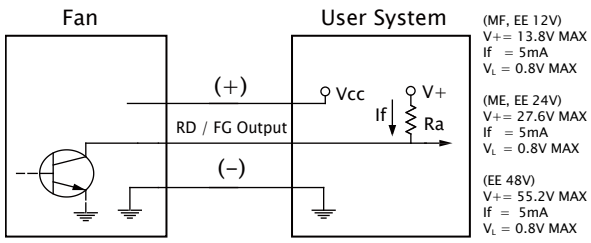

[RD Signal]

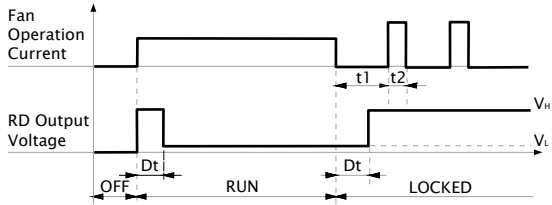

[FG Signal]

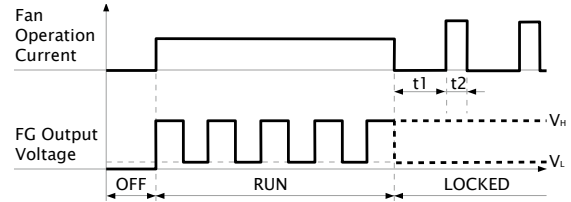
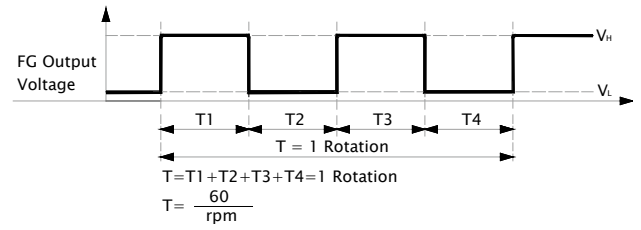

140x140x38 mm

238.5~297.9 CFM



■ Specification

Model	Bearing	Rated Voltage	Power Current	Power Consumption	Speed	Airflow	Static Pressure	Noise	Weight	Curve
	2BALL Sleeve	(VDC)	(mA)	(WATTS)	(RPM)	(CFM)	(inch-H ₂ O)	(dB(A))	(g)	
PFE0381BX-0000-A99	☉	12	3300	39.60	6800	297.9	2.05	68.3	472.0	1
PFE0381B1-0000-A99	☉	12	1720	20.64	5500	238.5	1.20	62.0	472.0	2

■ Function R Type : F99 / F Type : G99 / PWM : H99, Q99, S99

■ Air Flow-Static Pressure Characteristics

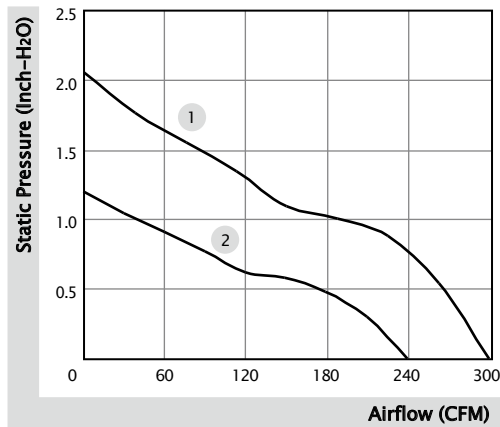

■ External Dimensions(mm)

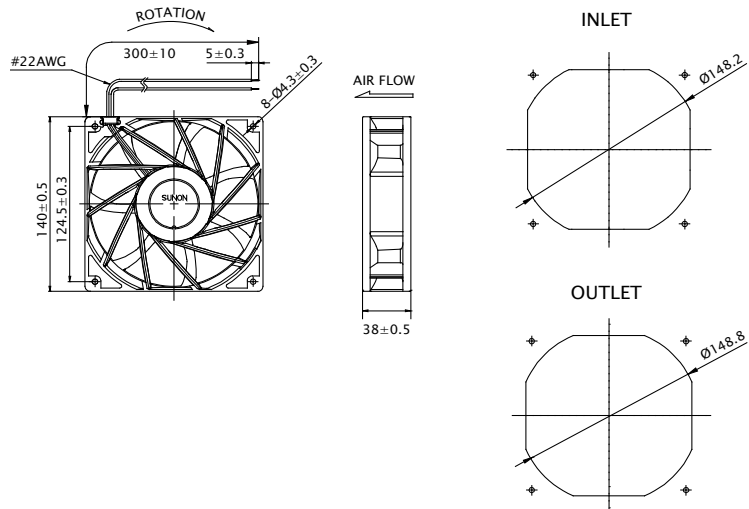

※ All model could be customized. Please contact with Sunon Sales.

※ Specifications are subject to change without notice. Please Visit SUNON website at www.sunon.com for update information.

■ RD / FG Output Signal

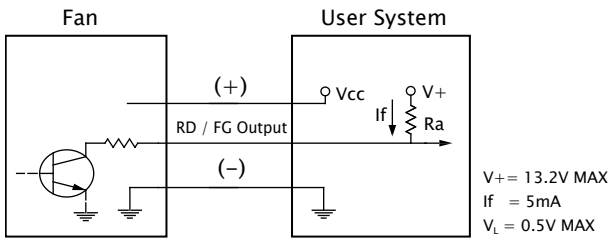

[RD Signal]

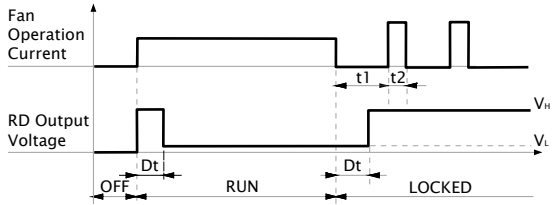

[FG Signal]

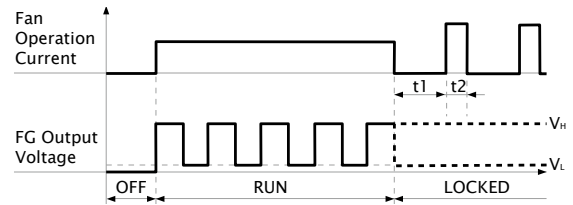
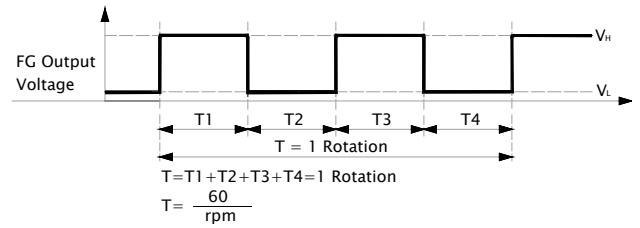

■ PWM Input Signal

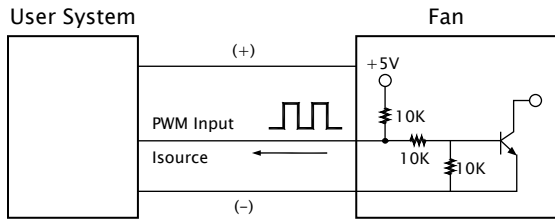

PWM FREQUENCY: 25KHZ
 Isource=0.5mA at PWM Input Voltage 0V
 The speed is default to be maximum if PWM input pin is unconnected.
 Min. start up duty cycle is 10%.

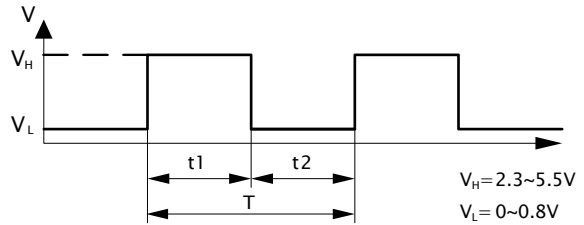

1. Period : $T = \frac{1}{f_{PWM}} = t1 + t2(\text{sec})$
2. Duty Cycle (D.C.) : $\frac{t1}{t1+t2} \times 100 = \frac{t1}{T} \times 100(\%)$

■ PWM Curve

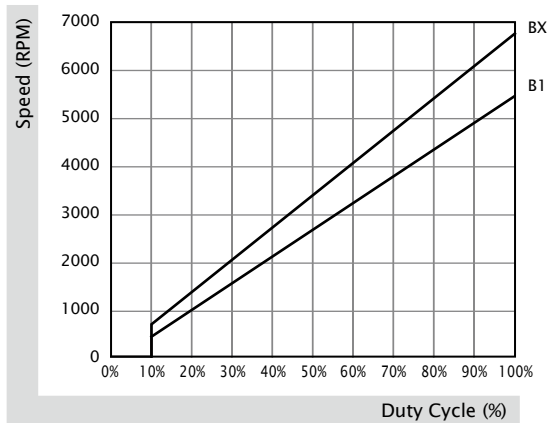

140x140x38 mm

282.6 CFM



■ Specification

Model	Bearing	Rated Voltage	Power Current	Power Consumption	Speed	Airflow	Static Pressure	Noise	Weight	Curve
	2BALL Sleeve	(VDC)	(mA)	(WATTS)	(RPM)	(CFM)	(inch-H ₂ O)	(dB(A))	(g)	
PFE0384BX-0000-A99	☉	48	740	35.52	6600	282.6	1.88	65.9	560.0	1

■ Function R Type : F99 / F Type : G99 / PWM : H99, Q99, S99

■ Air Flow-Static Pressure Characteristics

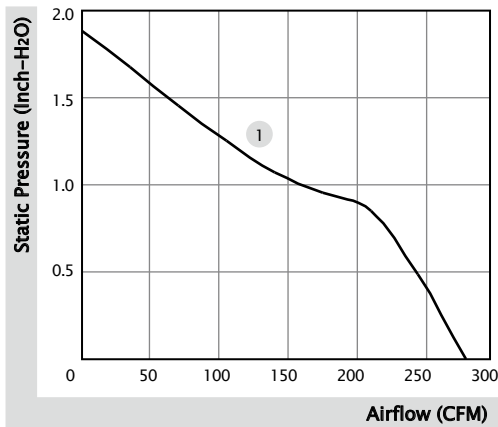

■ External Dimensions(mm)

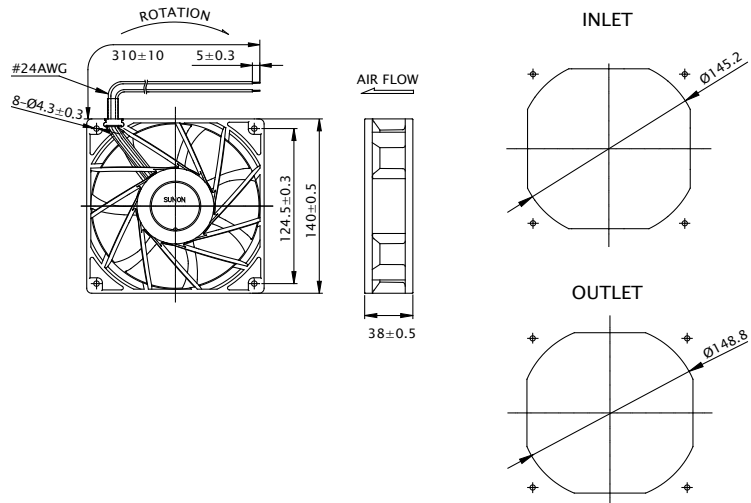

※ All model could be customized. Please contact with Sunon Sales.

※ Specifications are subject to change without notice. Please Visit SUNON website at www.sunon.com for update information.

■ RD / FG Output Signal

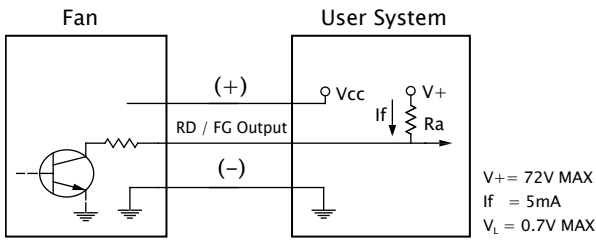

[RD Signal]

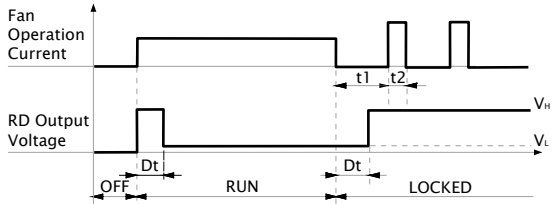

[FG Signal]

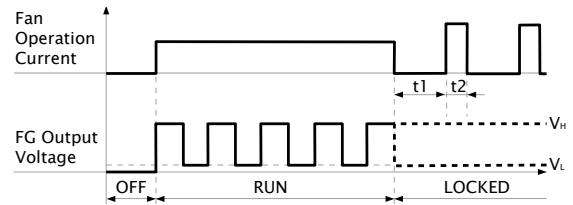
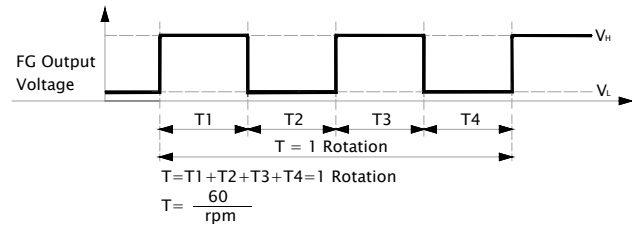

■ PWM Input Signal

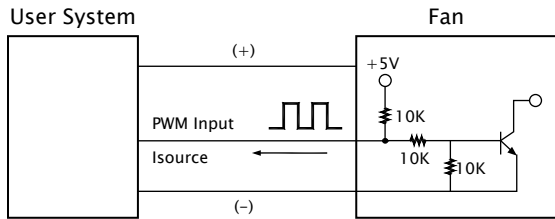

PWM FREQUENCY: 25KHZ
 Isource=0.5mA at PWM Input Voltage 0V
 The speed is default to be maximum if PWM input pin is unconnected.
 Min. start up duty cycle is 10%.

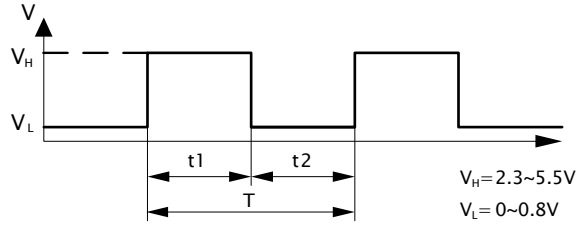

1. Period : $T = \frac{1}{f_{PWM}} = t1 + t2(\text{sec})$
2. Duty Cycle (D.C.) : $\frac{t1}{t1 + t2} \times 100 = \frac{t1}{T} \times 100(\%)$

■ PWM Curve

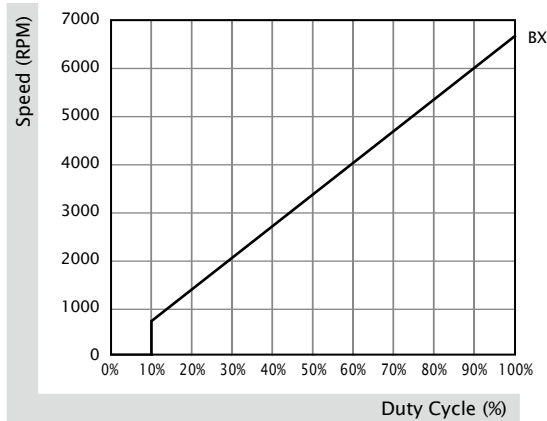

140x140x51 mm

250.3 CFM



■ Specification

Model	Bearing	Rated Voltage	Power Current	Power Consumption	Speed	Airflow	Static Pressure	Noise	Weight	Curve
	2BALL Sleeve	(VDC)	(mA)	(WATTS)	(RPM)	(CFM)	(inch-H ₂ O)	(dB(A))	(g)	
PFE0514B1-0000-A99	☉	48	470	22.56	5000	250.3	1.43	61.4	635.0	1

■ Function R Type : F99 / F Type : G99 / PWM : H99, Q99, S99

■ Air Flow-Static Pressure Characteristics

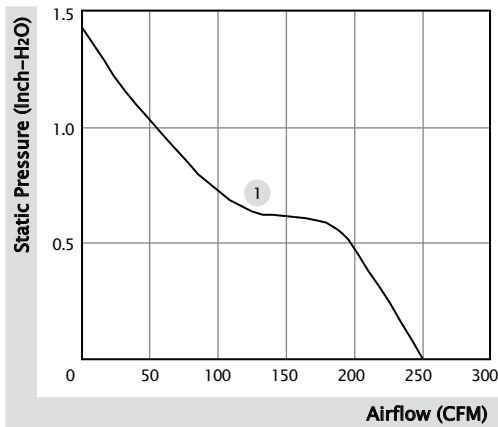

■ External Dimensions(mm)

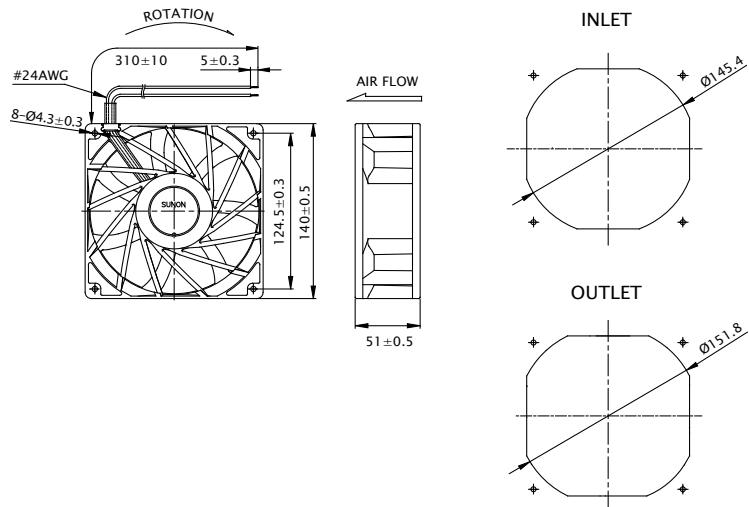

※ All model could be customized. Please contact with Sunon Sales.

※ Specifications are subject to change without notice. Please Visit SUNON website at www.sunon.com for update information.

■ RD / FG Output Signal

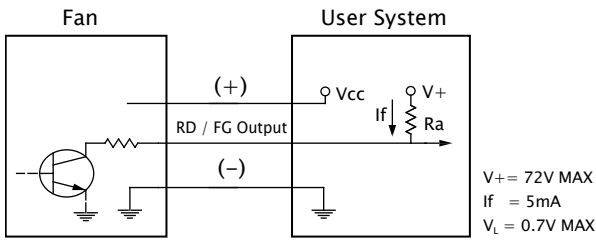

[RD Signal]

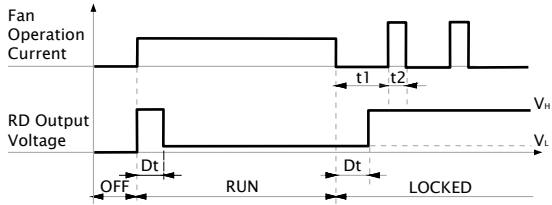

[FG Signal]

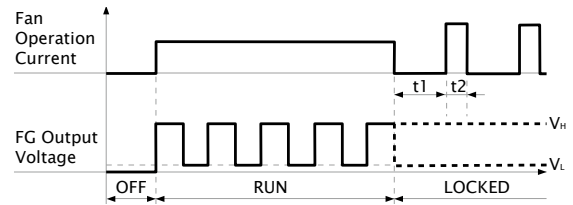
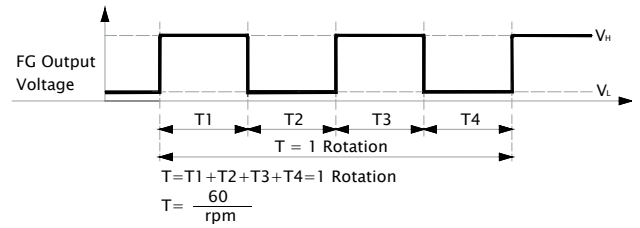

■ PWM Input Signal

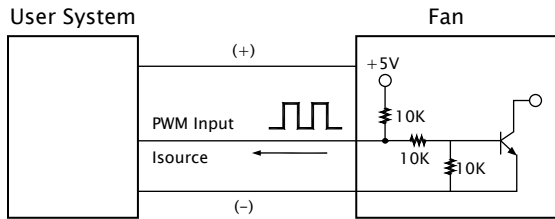

PWM FREQUENCY: 25KHZ
 Isource=0.5mA at PWM Input Voltage 0V
 The speed is default to be maximum if PWM input pin is unconnected.
 Min. start up duty cycle is 10%.

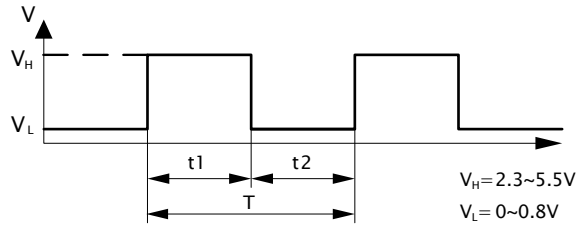

1. Period : $T = \frac{1}{f_{PWM}} = t1 + t2(\text{sec})$

2. Duty Cycle (D.C.) : $\frac{t1}{t1+t2} \times 100 = \frac{t1}{T} \times 100(\%)$

■ PWM Curve

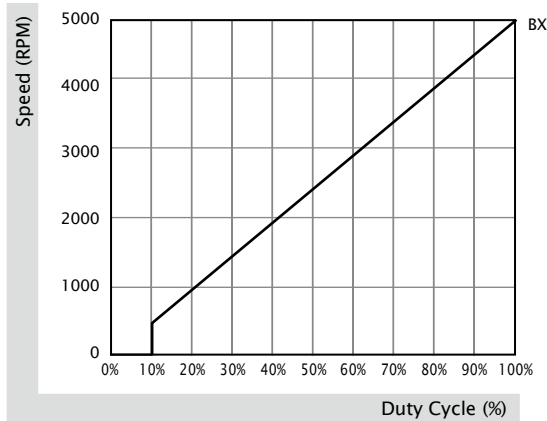

■ DC Blower New Model Numbering System

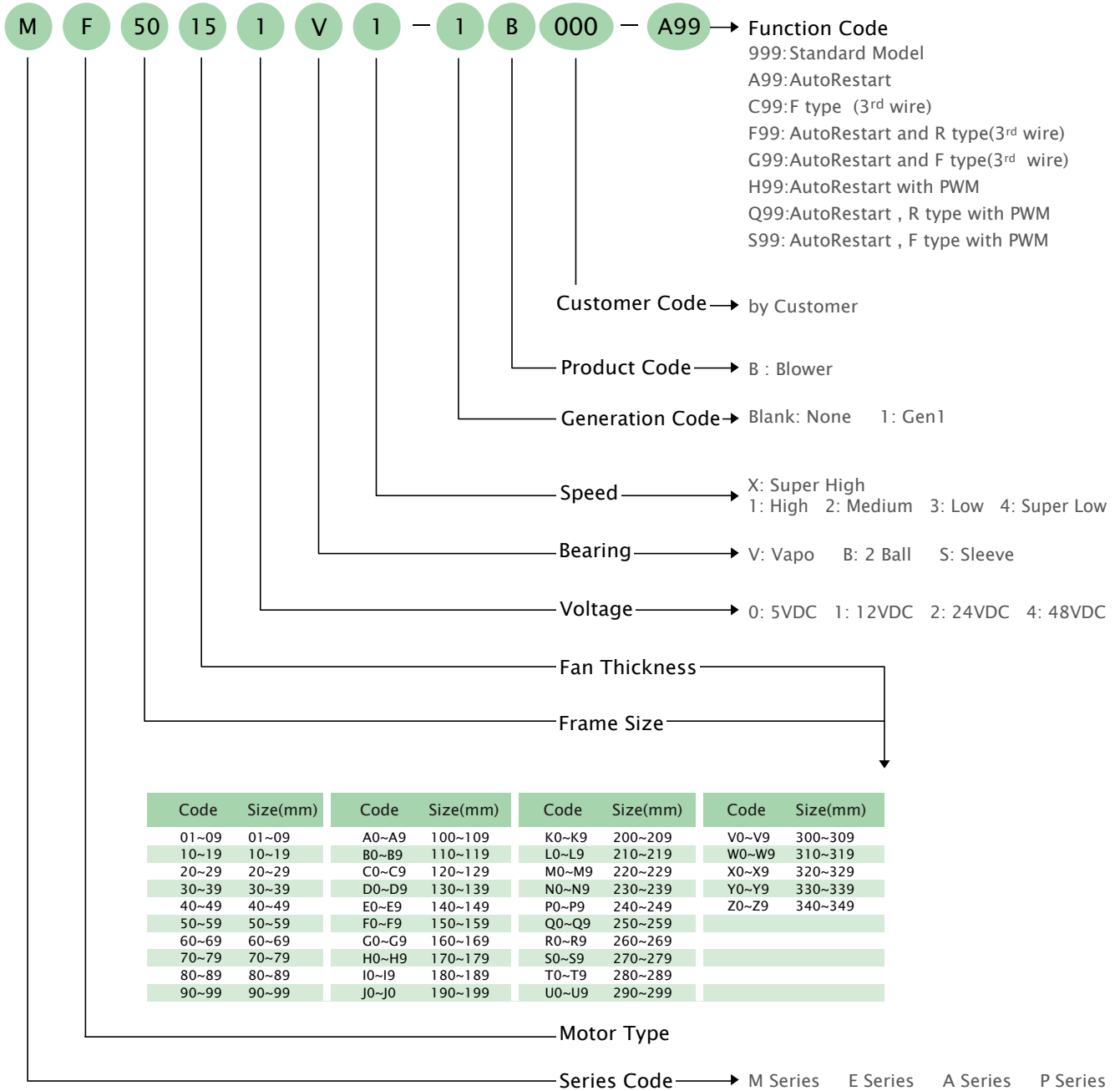

Certification



Safety



- ※ Note: For critical or extreme environments, including non stop operation, please contact SUNON and we will gladly provide assistance with your product selection to ensure an appropriate cooling product for your application.
- ※ Note: The “Life Expectancy” of the fan has not been evaluated for use in combination with any end application. Therefore, the Life Expectancy Test Reports(L10 and MTTF Report) that relate to the fan are only for reference.

■ DC Blower Old Model Numbering System

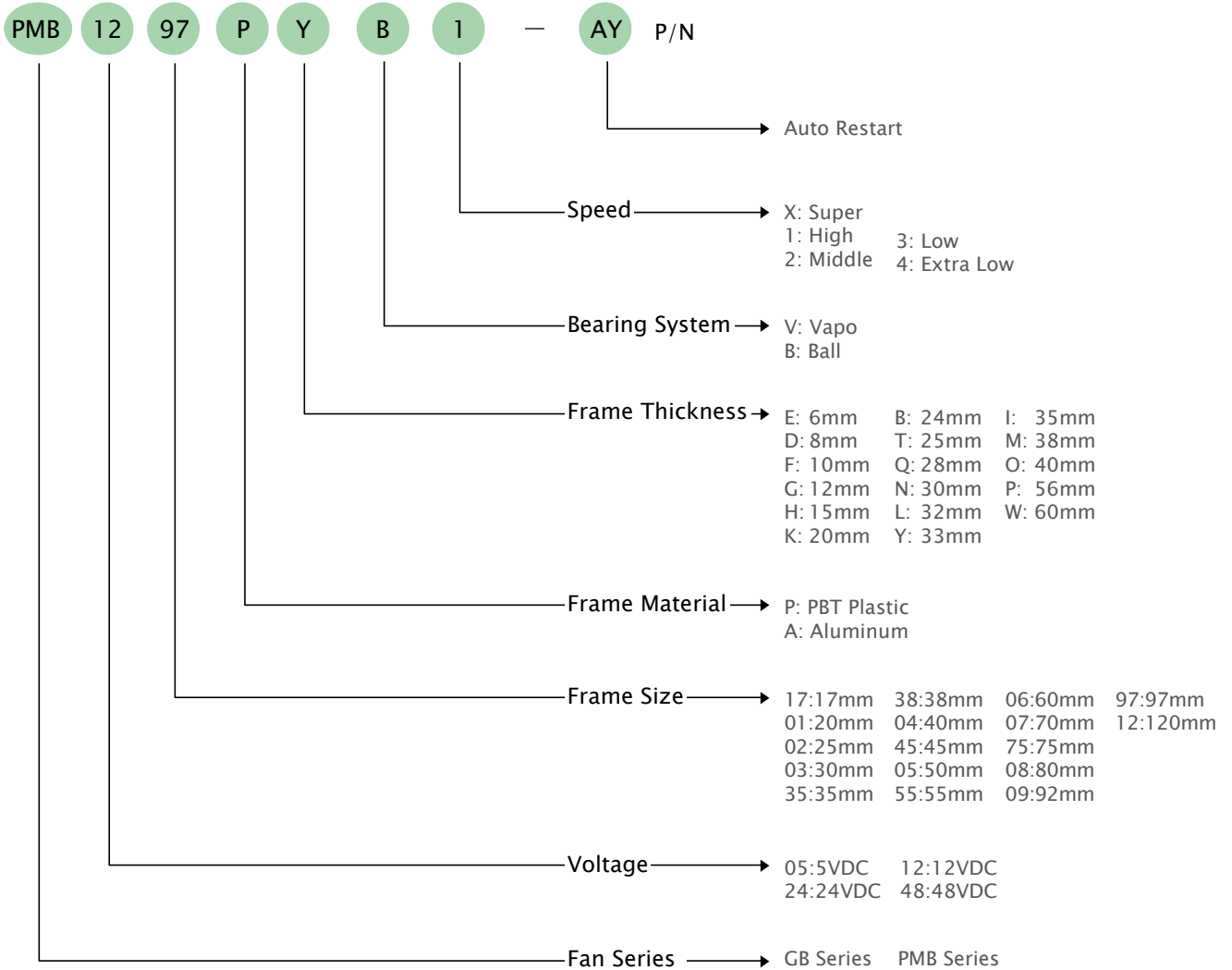

P/N

Example : PMB1297PYB1-AY P/N:(2).GN

- (2) Two ball bearing
- GN RoHS compliance

Certification



Safety



※ Note: For critical or extreme environments, including non stop operation, please contact SUNON and we will gladly provide assistance with your product selection to ensure an appropriate cooling product for your application.
 ※ Note: The "Life Expectancy" of the fan has not been evaluated for use in combination with any end application. Therefore, the Life Expectancy Test Reports(L10 and MTTF Report) that relate to the fan are only for reference.

50x50x15 mm

2.7~5.4 CFM



■ Specification

	Bearing	Rated Voltage	Power Current	Power Consumption	Speed	Airflow	Static Pressure	Noise	Weight	Curve
	● VAPO	(VDC)	(mA)	(WATTS)	(RPM)	(CFM)	(inch-H ₂ O)	(dB(A))	(g)	
MF50151VX-1B000-A99	●	12	155	1.86	6200	5.4	0.97	42.2	30.0	1
MF50151V1-1B000-A99	●	12	95	1.14	5200	4.5	0.67	39.6	30.0	2
MF50151V2-1B000-A99	●	12	45	0.54	4200	3.5	0.40	32.6	30.0	3
MF50151V3-1B000-A99	●	12	30	0.36	3200	2.7	0.18	23.2	30.0	4

■ Function R Type : F99 / F Type : G99

■ Air Flow-Static Pressure Characteristics

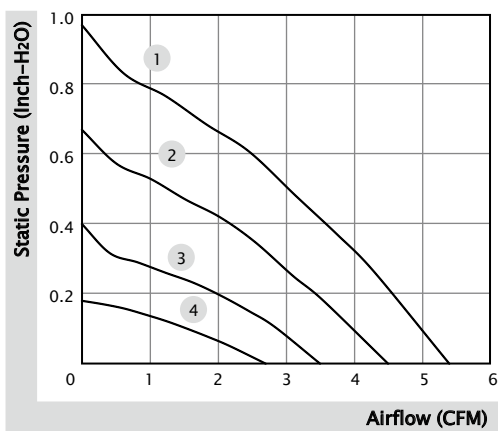

■ External dimensions(mm)

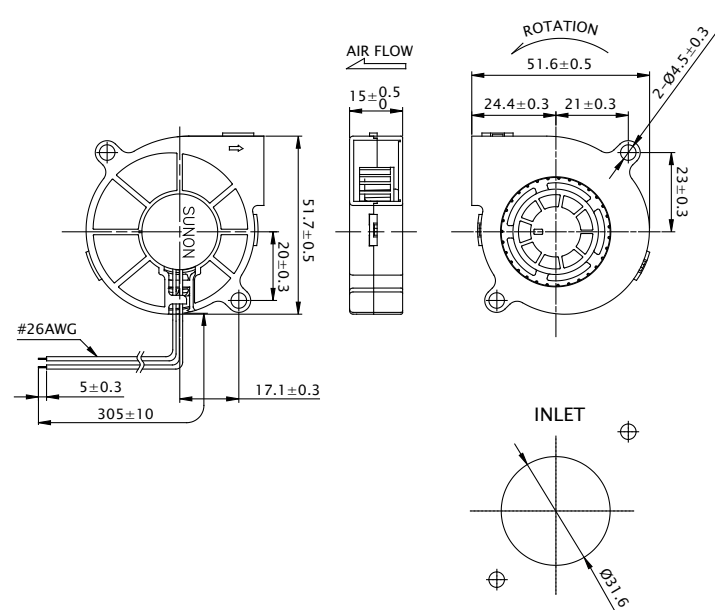

※ All model could be customized. Please contact with Sunon Sales.

※ Specifications are subject to change without notice. Please Visit SUNON website at www.sunon.com for update information.

■ RD / FG Output Signal

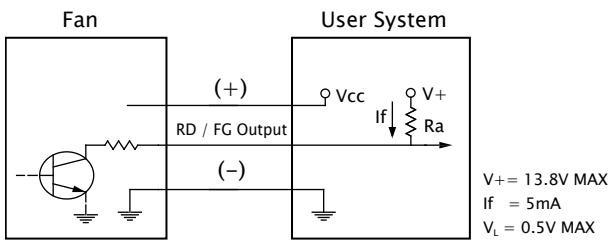

[RD Signal]

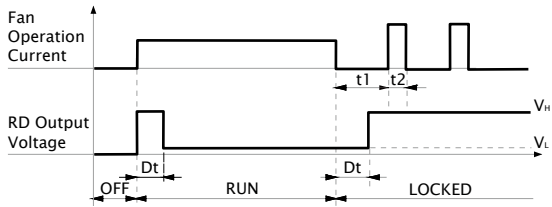

[FG Signal]

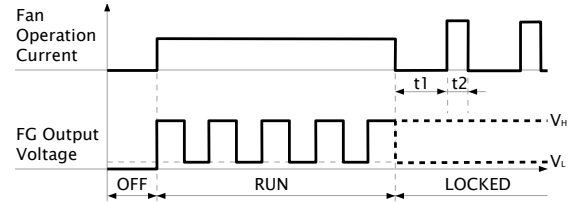
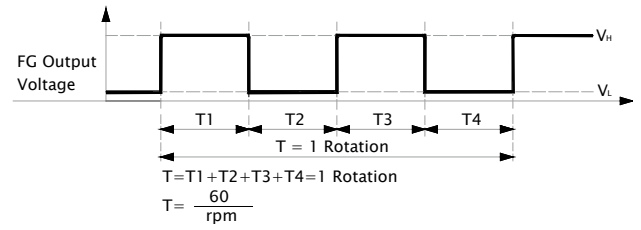

50x50x15 mm

2.6~5.4 CFM



■ Specification

Model	Bearing	Rated Voltage	Power Current	Power Consumption	Speed	Airflow	Static Pressure	Noise	Weight	Curve
	2BALL Sleeve	(VDC)	(mA)	(WATTS)	(RPM)	(CFM)	(inch-H ₂ O)	(dB(A))	(g)	
EF50151BX-1B000-A99	☉	12	150	1.80	6200	5.4	0.97	45.8	31.0	1
EF50151B1-1B000-A99	☉	12	106	1.28	5200	4.5	0.67	41.0	31.0	2
EF50151B2-1B000-A99	☉	12	54	0.65	4200	3.5	0.40	34.0	31.0	3
EF50151B3-1B000-A99	☉	12	36	0.44	3200	2.6	0.18	26.0	31.0	4

■ Function R Type : F99 / F Type : G99

■ Air Flow-Static Pressure Characteristics

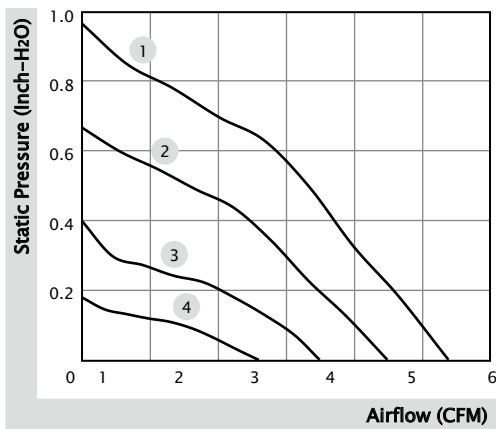

■ External dimensions(mm)

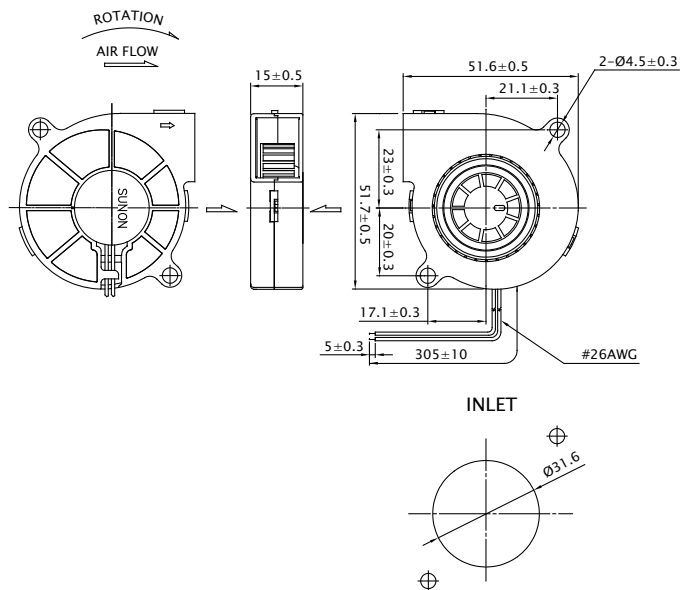

※ All model could be customized. Please contact with Sunon Sales.

※ Specifications are subject to change without notice. Please Visit SUNON website at www.sunon.com for update information.

■ RD / FG Output Signal

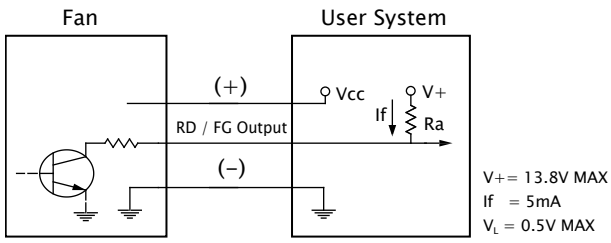

[RD Signal]

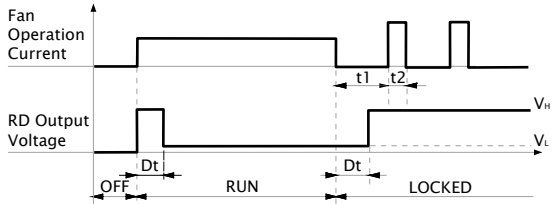

[FG Signal]

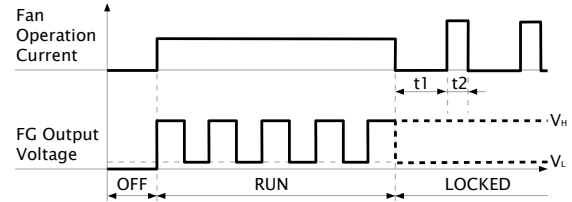
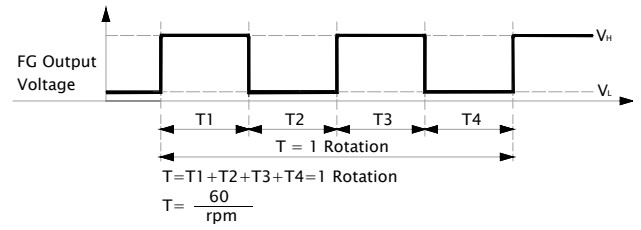

50x50x20 mm

4.8~5.8 CFM



■ Specification

	Bearing	Rated Voltage	Power Current	Power Consumption	Speed	Airflow	Static Pressure	Noise	Weight	Curve
	● VAPO	(VDC)	(mA)	(WATTS)	(RPM)	(CFM)	(inch-H ₂ O)	(dB(A))	(g)	
MF50201V1-1B000-A99	●	12	124	1.49	5300	5.8	0.66	34.8	34.0	1
MF50201V2-1B000-A99	●	12	100	1.20	4650	5.1	0.46	30.0	34.0	2
MF50201V3-1B000-A99	●	12	75	0.90	4350	4.8	0.35	27.5	34.0	3

■ Function R Type : F99 / F Type : G99

■ Air Flow-Static Pressure Characteristics

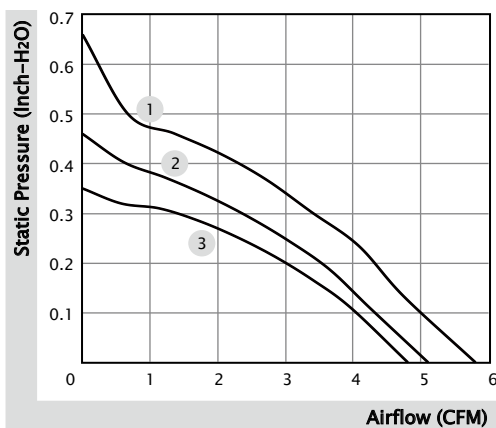

■ External dimensions(mm)

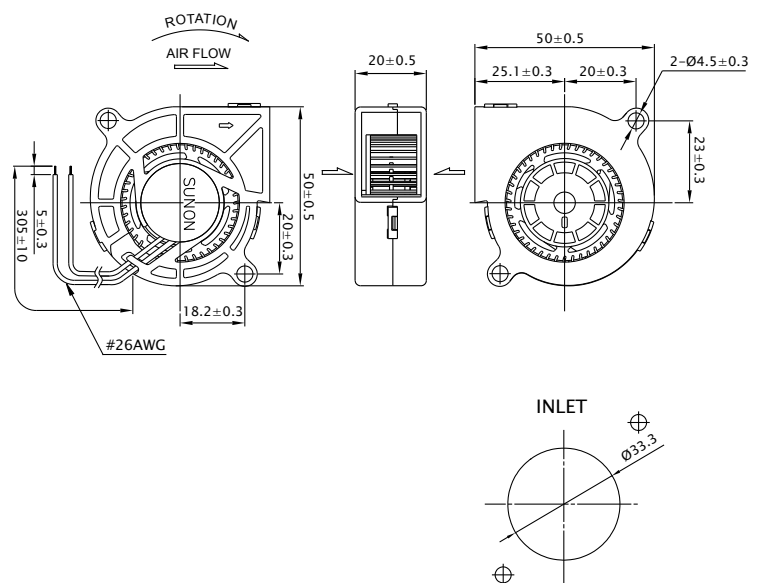

※ All model could be customized. Please contact with Sunon Sales.

※ Specifications are subject to change without notice. Please Visit SUNON website at www.sunon.com for update information.

■ RD / FG Output Signal

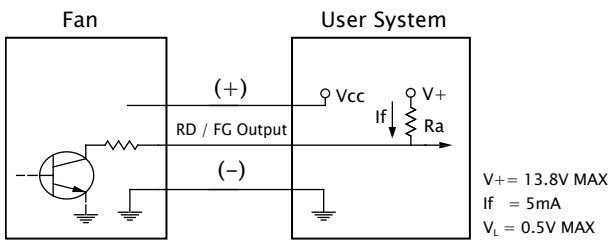

[RD Signal]

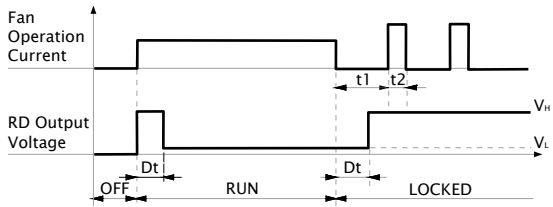

[FG Signal]

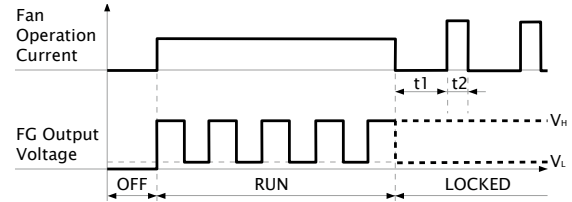
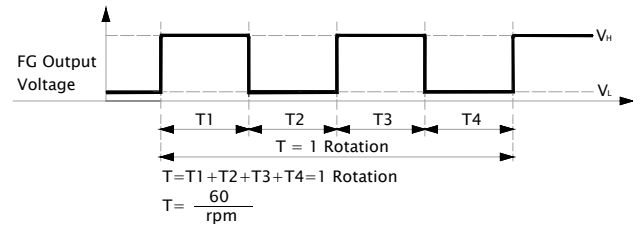

60x60x15 mm

5.1~6.2 CFM

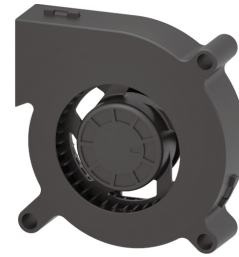

■ Specification

Model	Bearing	Rated Voltage	Power Current	Power Consumption	Speed	Airflow	Static Pressure	Noise	Weight	Curve
	2BALL Sleeve	(VDC)	(mA)	(WATTS)	(RPM)	(CFM)	(inch-H ₂ O)	(dB(A))	(g)	
MF60151VX-1B000-A99	☉	12	130	1.56	4500	6.2	0.71	37.7	36.0	1
MF60151V1-1B000-A99	☉	12	75	0.90	4000	5.7	0.46	32.8	36.0	2
MF60151V2-1B000-A99	☉	12	55	0.66	3600	5.1	0.33	29.0	36.0	3

■ Function R Type : F99 / F Type : G99

■ Air Flow-Static Pressure Characteristics

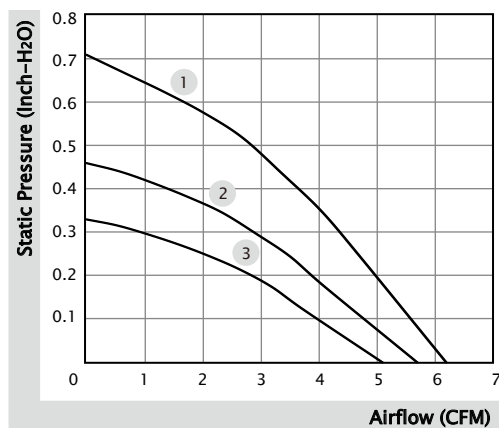

■ External dimensions(mm)

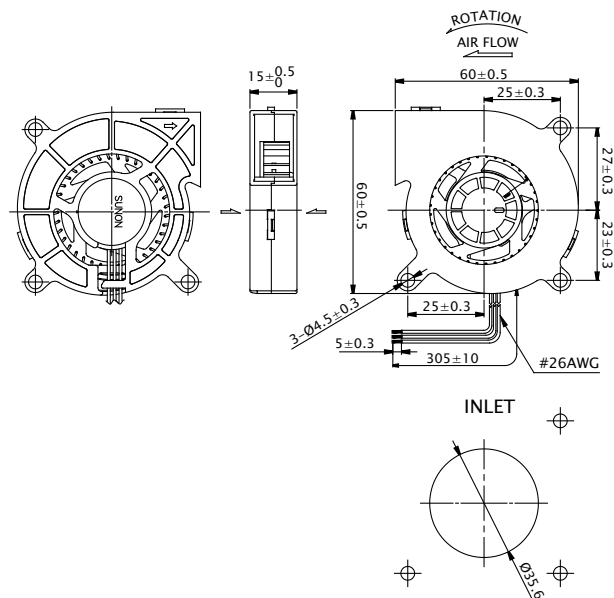

※ All model could be customized. Please contact with Sunon Sales.

※ Specifications are subject to change without notice. Please Visit SUNON website at www.sunon.com for update information.

■ RD / FG Output Signal

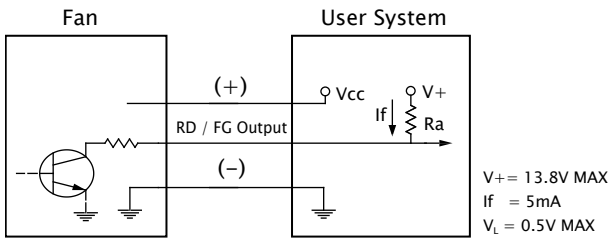

[RD Signal]

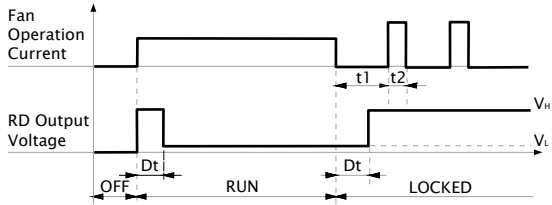

[FG Signal]

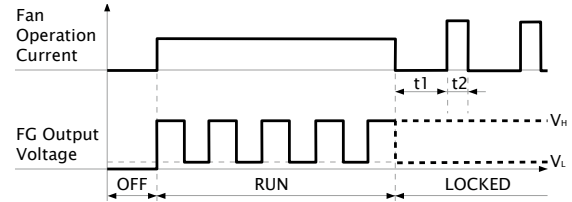
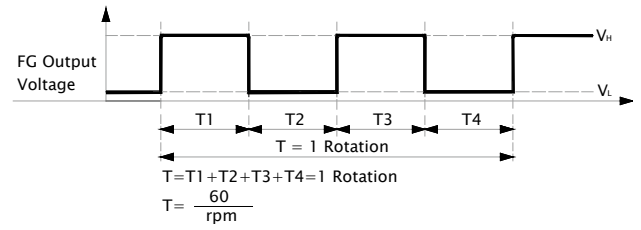

75x75x30 mm

10.8~15.5 CFM



■ Specification

Model	Bearing	Rated Voltage	Power Current	Power Consumption	Speed	Airflow	Static Pressure	Noise	Weight	Curve
	2BALL Sleeve	(VDC)	(mA)	(WATTS)	(RPM)	(CFM)	(inch-H ₂ O)	(dB(A))	(g)	
PF75301B1-1B000-A99	☉	12	200	2.40	3400	15.5	0.57	42.0	85.0	1
PF75301B2-1B000-A99	☉	12	142	1.71	3000	13.8	0.43	38.6	85.0	2
PF75301B3-1B000-A99	☉	12	82	0.99	2400	10.8	0.24	32.9	85.0	3
PF75302B1-1B000-A99	☉	24	115	2.76	3400	15.5	0.57	42.0	88.0	1
PF75302B2-1B000-A99	☉	24	80	1.92	3000	13.8	0.43	38.6	88.0	2
PF75302B3-1B000-A99	☉	24	47	1.13	2400	10.8	0.24	32.9	88.0	3

■ Function R Type : F99 / F Type : G99 / PWM : H99, Q99, S99

■ Air Flow-Static Pressure Characteristics

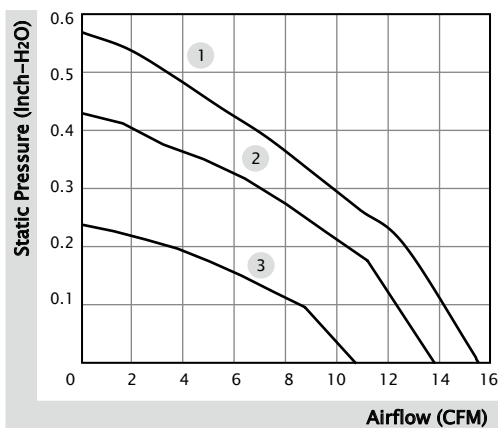

■ External dimensions(mm)

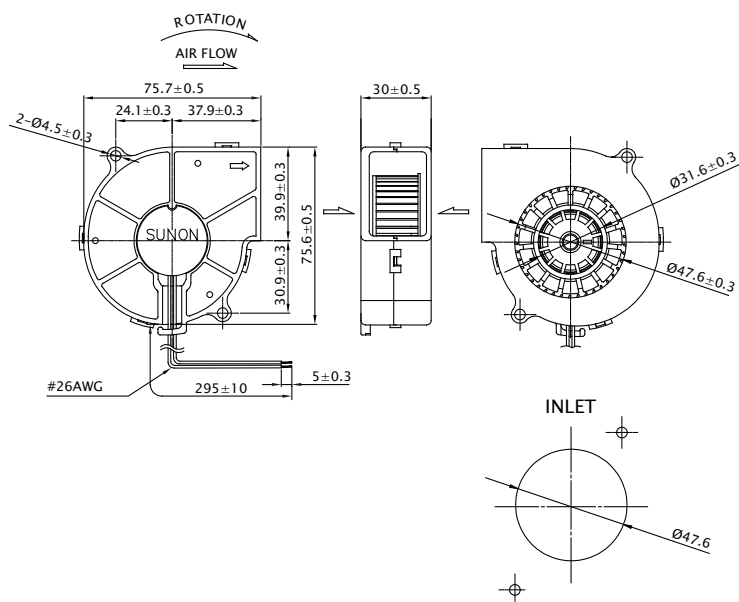

※ All model could be customized. Please contact with Sunon Sales.

※ Specifications are subject to change without notice. Please Visit SUNON website at www.sunon.com for update information.

■ RD / FG Output Signal

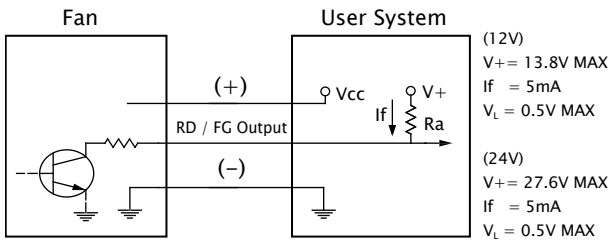

[RD Signal]

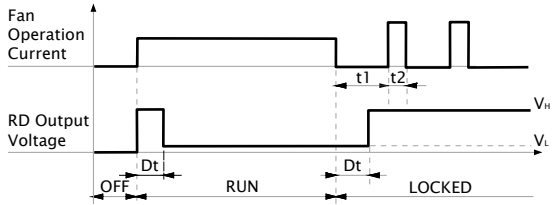

[FG Signal]

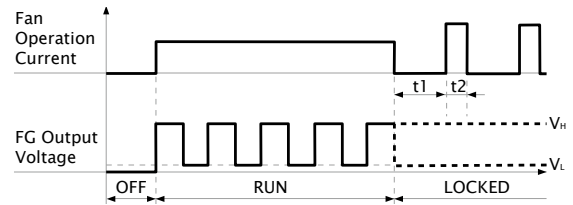
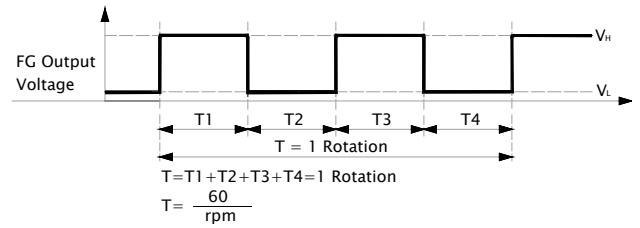

■ PWM Input Signal

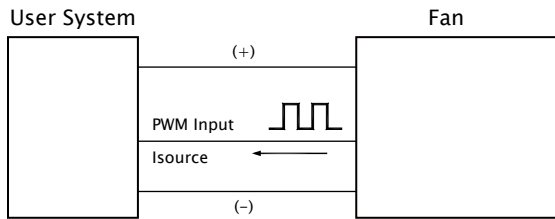

PWM FREQUENCY: 25KHZ
 $I_{source} = 0.5mA$ at PWM Input Voltage 0V
 The speed is default to be maximum if PWM input pin is unconnected.
 Min. start up duty cycle is 10%.

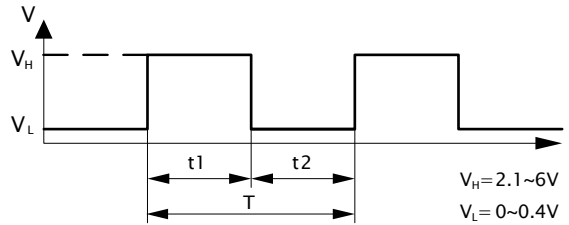

1. Period : $T = \frac{1}{f_{PWM}} = t_1 + t_2 (\text{sec})$

2. Duty Cycle (D.C.) : $\frac{t_1}{t_1 + t_2} \times 100 = \frac{t_1}{T} \times 100(\%)$

■ PWM Curve

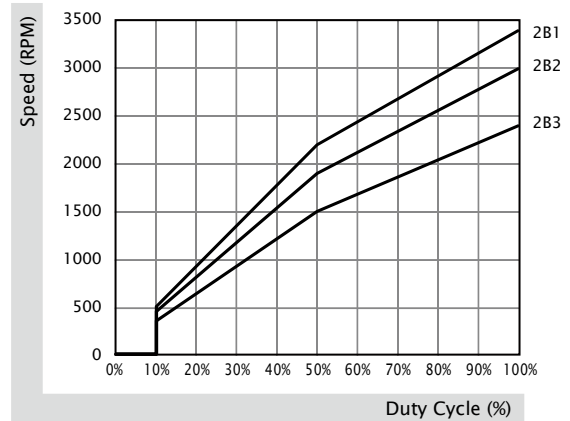
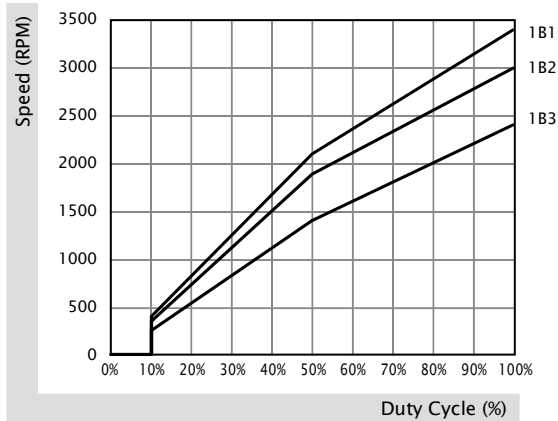

97x94x33 mm

22.4~30.5 CFM



■ Specification

Model	Bearing	Rated Voltage	Power Current	Power Consumption	Speed	Airflow	Static Pressure	Noise	Weight	Curve
	2BALL Sleeve	(VDC)	(mA)	(WATTS)	(RPM)	(CFM)	(inch-H ₂ O)	(dB(A))	(g)	
PMB1297PYB1-AY (2).GN	☉	12	600	7.20	3600	30.5	0.92	55.8	185.00	1
PMB1297PYB2-AY (2).GN	☉	12	440	5.28	3200	26.6	0.65	53.1	185.00	2
PMB1297PYB3-AY (2).GN	☉	12	300	3.60	2700	22.4	0.43	50.0	185.00	3

■ Function R Type : (2).R.GN / F Type : (2).F.GN

■ Air Flow-Static Pressure Characteristics

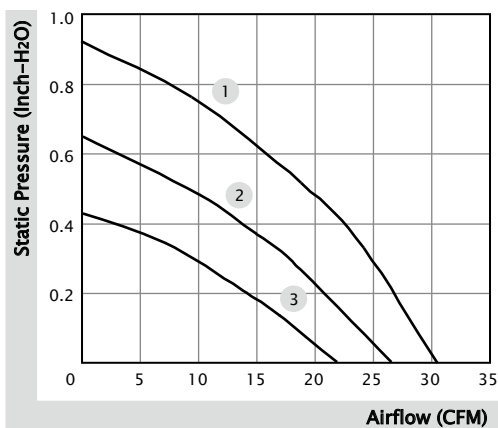

■ External dimensions(mm)

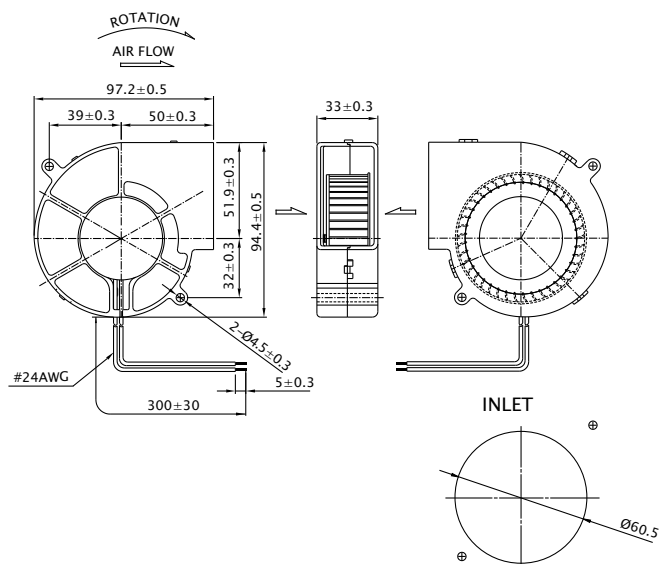

※ All model could be customized. Please contact with Sunon Sales.

※ Specifications are subject to change without notice. Please Visit SUNON website at www.sunon.com for update information.

■ RD / FG Output Signal

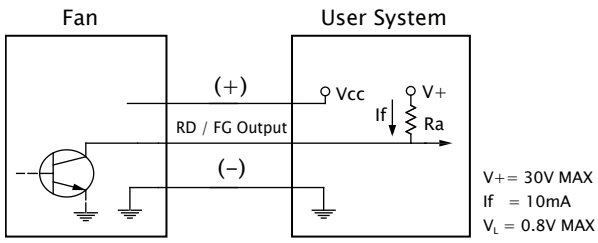

[RD Signal]

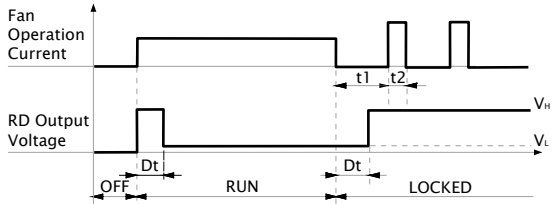

[FG Signal]

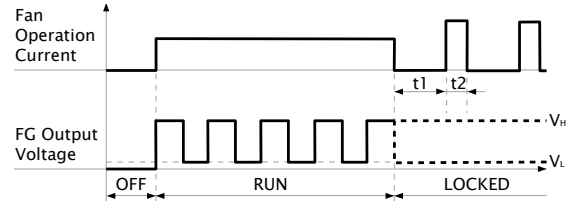
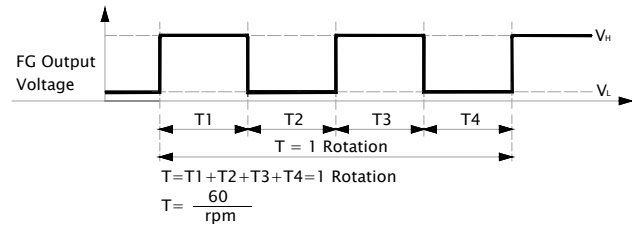

97x95x33 mm

44.2~54.7 CFM



■ Specification

Model	Bearing	Rated Voltage	Power Current	Power Consumption	Speed	Airflow	Static Pressure	Noise	Weight	Curve
	2BALL Sleeve	(VDC)	(mA)	(WATTS)	(RPM)	(CFM)	(inch-H ₂ O)	(dB(A))	(g)	
PF97331BX-B000-A99	☉	12	3500	42.00	6800	54.7	5.22	63.2	184.0	1
PF97331B1-B000-A99	☉	12	1600	19.20	5400	44.2	3.39	58.0	184.0	2

■ Function R Type : F99 / F Type : G99 / PWM : H99, Q99, S99

■ Air Flow-Static Pressure Characteristics

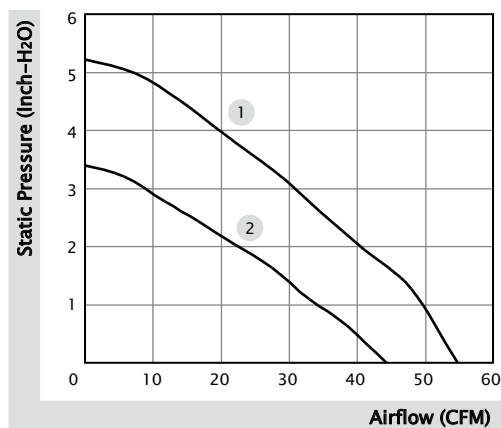

■ External dimensions(mm)

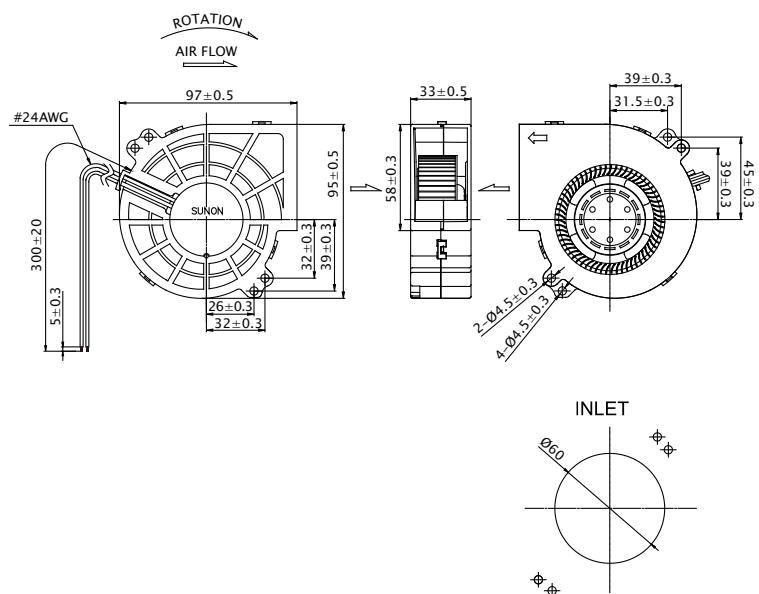

※ All model could be customized. Please contact with Sunon Sales.

※ Specifications are subject to change without notice. Please Visit SUNON website at www.sunon.com for update information.

■ RD / FG Output Signal

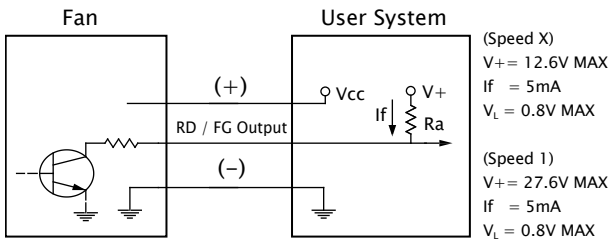

[RD Signal]

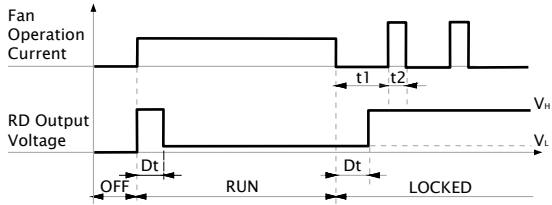

[FG Signal]

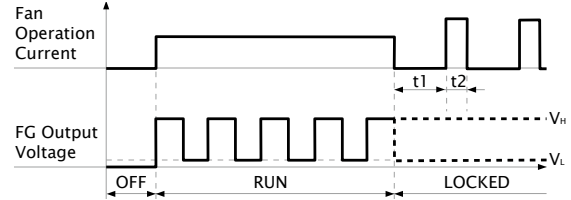
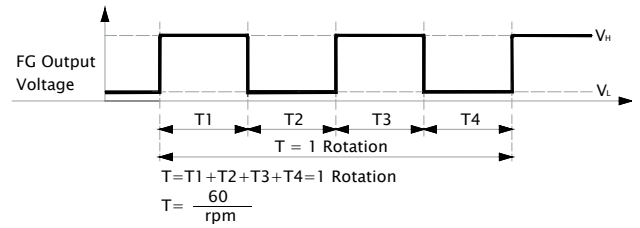

■ PWM Input Signal

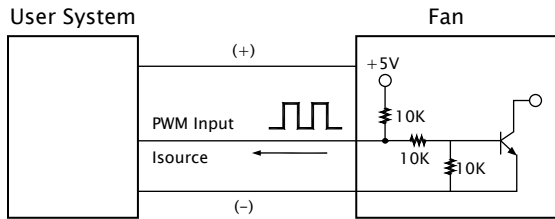

PWM FREQUENCY: 25KHZ
 Isource=0.5mA at PWM Input Voltage 0V
 The speed is default to be maximum if PWM input pin is unconnected.
 Min. start up duty cycle is 10%.

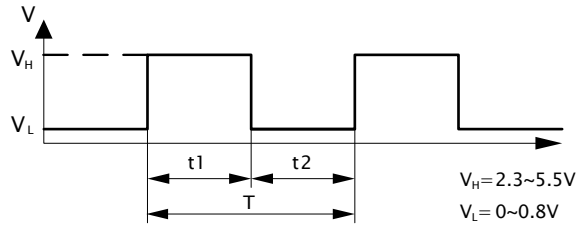

1. Period : $T = \frac{1}{f_{PWM}} = t1 + t2(\text{sec})$

2. Duty Cycle (D.C.) : $\frac{t1}{t1+t2} \times 100 = \frac{t1}{T} \times 100(\%)$

■ PWM Curve

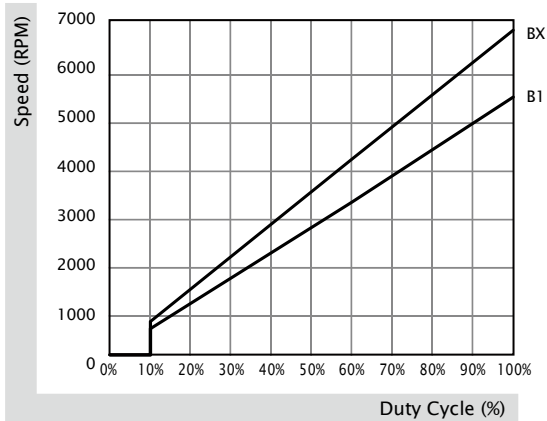

100x100x25 mm

for Automotive Application

18.4 CFM

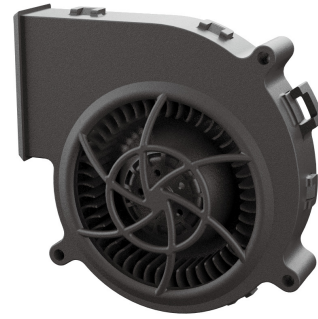

■ Specification

Model	Bearing	Rated Voltage	Power Current	Power Consumption	Speed	Airflow	Static Pressure	Noise	Weight	Curve
	2BALL Sleeve	(VDC)	(mA)	(WATTS)	(RPM)	(CFM)	(inch-H ₂ O)	(dB(A))	(g)	
AFA0251B1-1B000-H99	☉	13.5	520	7.02	3800	18.4	0.86	52.3	110	1

■ Function PWM : S99

■ Air Flow-Static Pressure Characteristics

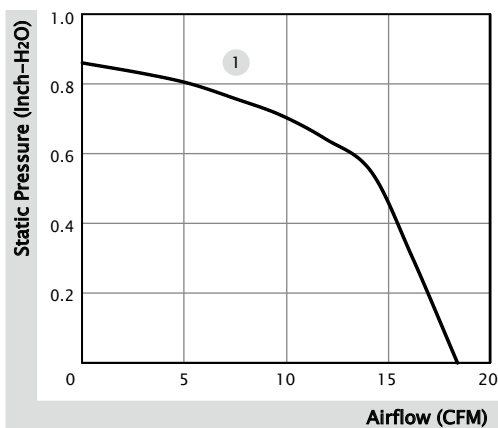

■ External dimensions(mm)

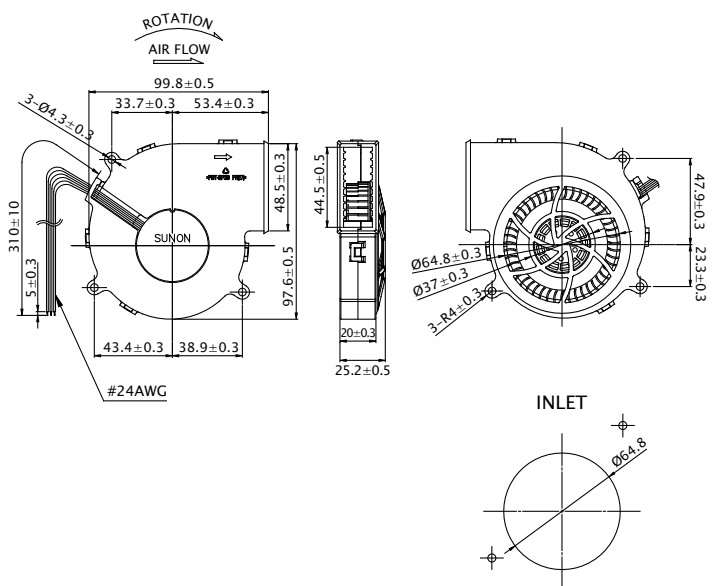

※ All model could be customized. Please contact with Sunon Sales.

※ Specifications are subject to change without notice. Please Visit SUNON website at www.sunon.com for update information.

■ FG Output Signal

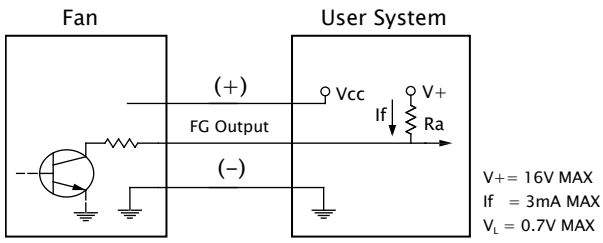

[FG Signal]

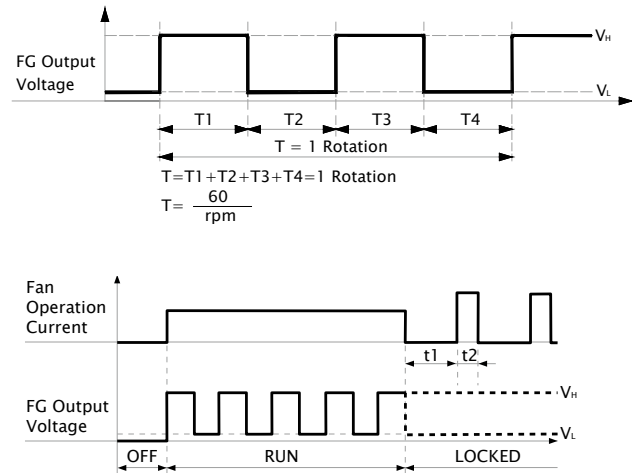

■ PWM Input Signal

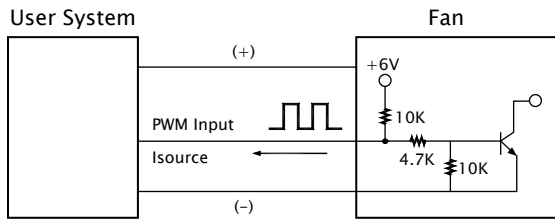

PWM FREQUENCY: 25KHZ
 $I_{\text{source}} = 2mA$ at PWM Input Voltage 0V
 The speed is default to be maximum if PWM input pin is unconnected.
 Min. start up duty cycle is 10%.

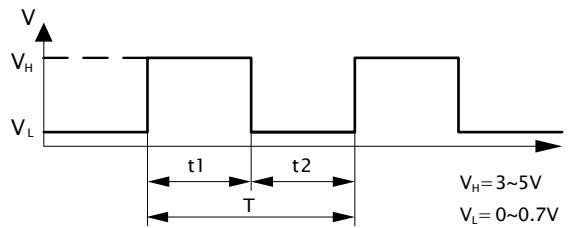

1. Period : $T = \frac{1}{f_{\text{PWM}}} = t_1 + t_2 (\text{sec})$

2. Duty Cycle (D.C.) : $\frac{t_1}{t_1 + t_2} \times 100 = \frac{t_1}{T} \times 100(\%)$

■ PWM Curve

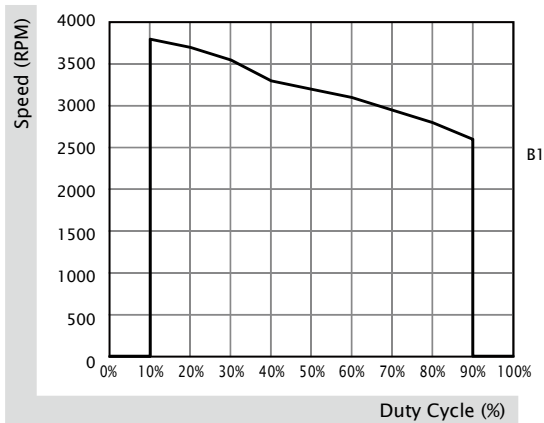

120x120x32 mm

31.4~35.9 CFM

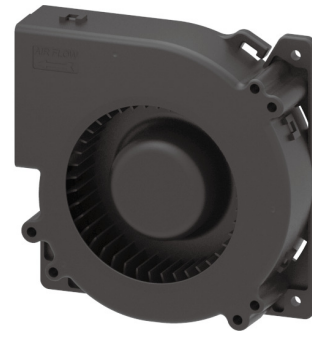

■ Specification

Model	Bearing	Rated Voltage	Power Current	Power Consumption	Speed	Airflow	Static Pressure	Noise	Weight	Curve
	2BALL Sleeve	(VDC)	(mA)	(WATTS)	(RPM)	(CFM)	(inch-H ₂ O)	(dB(A))	(g)	
PMB1212PLB2-A (2).GN	☉	12	820	9.8	2500	35.9	0.89	53.8	250.0	1
PMB1212PLB3-A (2).GN	☉	12	450	5.4	2100	31.4	0.64	49.6	250.0	2

■ Function R Type : (2).R.GN / F Type : (2).F.GN

■ Air Flow-Static Pressure Characteristics

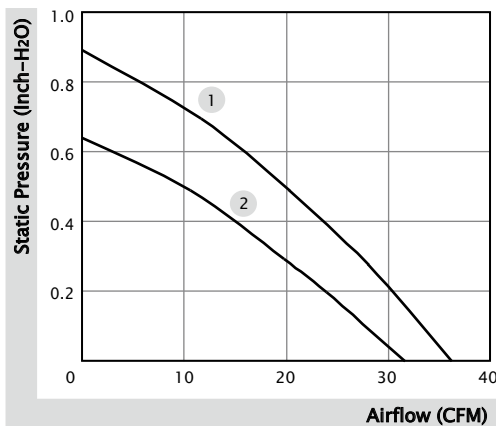

■ External dimensions(mm)

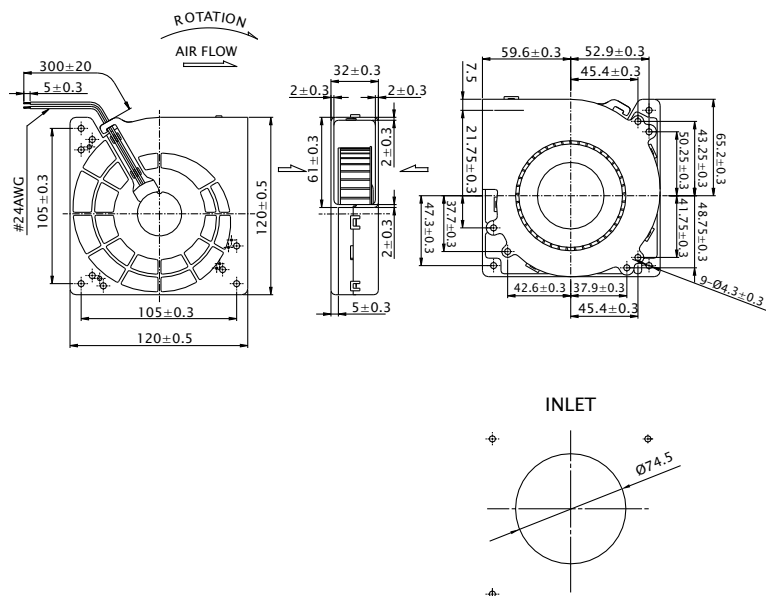

※ All model could be customized. Please contact with Sunon Sales.

※ Specifications are subject to change without notice. Please Visit SUNON website at www.sunon.com for update information.

■ RD / FG Output Signal

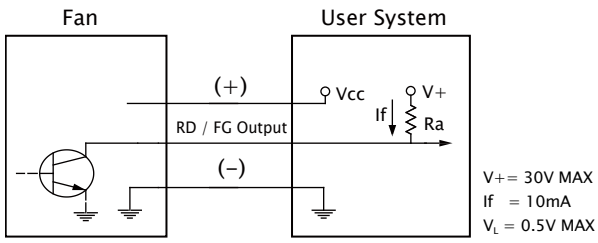

[RD Signal]

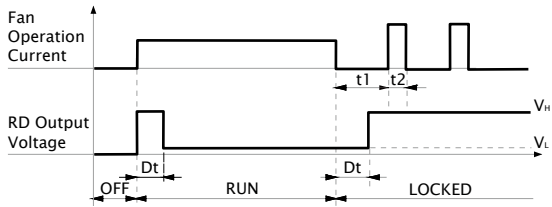

[FG Signal]

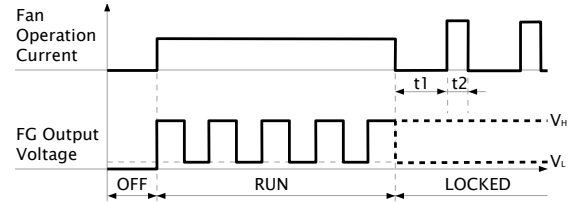
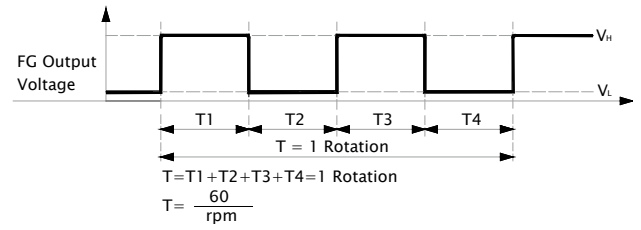



www.sunon.com

SUNON®

Headquarters
Sunonwealth Electric Machine Industry Co., Ltd.

TEL : +886-7-8135888
E-mail : sunon@sunon.com

2021/07/20 (255-A)

© 2021 SUNONWEALTH Electric Machine Industry Co., Ltd.